

The RF Sub-Micron MOSFET Line
RF Power Field Effect Transistor
N-Channel Enhancement-Mode Lateral MOSFET

Designed for W-CDMA base station applications with frequencies from 2110 to 2170 MHz. Suitable for TDMA, CDMA and multicarrier amplifier applications. To be used in Class AB for PCN-PCS/cellular radio and WLL applications.

- Typical 2-carrier W-CDMA Performance for $V_{DD} = 28$ Volts, $I_{DQ} = 2 \times 800$ mA, $f_1 = 2135$ MHz, $f_2 = 2145$ MHz, Channel Bandwidth = 3.84 MHz, Adjacent Channels Measured over 3.84 MHz BW @ $f_1 - 5$ MHz and $f_2 + 5$ MHz. Distortion Products Measured over a 3.84 MHz BW @ $f_1 - 10$ MHz and $f_2 + 10$ MHz, Each Carrier Peak/Avg. = 8.5 dB @ 0.01% Probability on CCDF.
 Output Power — 38 Watts Avg.
 Power Gain — 14 dB
 Efficiency — 25.5%
 IM3 — 37.5 dBc
 ACPR — -41 dBc
- Internally Matched, Controlled Q, for Ease of Use
- High Gain, High Efficiency and High Linearity
- Integrated ESD Protection
- Designed for Maximum Gain and Insertion Phase Flatness
- Capable of Handling 10:1 VSWR, @ 28 Vdc, 2140 MHz, 180 Watts CW Output Power
- Excellent Thermal Stability
- Characterized with Series Equivalent Large-Signal Impedance Parameters
- Qualified Up to a Maximum of 32 V_{DD} Operation

MRF5P21180

**2170 MHz, 180 W AVG.,
2 x W-CDMA, 28 V
LATERAL N-CHANNEL
RF POWER MOSFET**

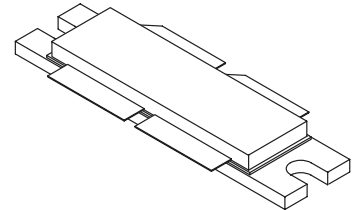

**CASE 375D-04, STYLE 1
NI-1230**

MAXIMUM RATINGS

Rating	Symbol	Value	Unit
Drain-Source Voltage	V_{DSS}	65	Vdc
Gate-Source Voltage	V_{GS}	-0.5, +15	Vdc
Total Device Dissipation @ $T_C = 25^\circ\text{C}$ Derate above 25°C	P_D	437.5 2.5	Watts W/ $^\circ\text{C}$
Storage Temperature Range	T_{stg}	-65 to +150	$^\circ\text{C}$
Operating Junction Temperature	T_J	200	$^\circ\text{C}$

NOTE – **CAUTION** – MOS devices are susceptible to damage from electrostatic charge. Reasonable precautions in handling and packaging MOS devices should be observed.

THERMAL CHARACTERISTICS

Characteristic	Symbol	Max	Unit
Thermal Resistance, Junction to Case Case Temperature 80°C, 180 W CW Case Temperature 80°C, 38 W CW	$R_{\theta JC}$	0.40 0.40	°C/W

ELECTRICAL CHARACTERISTICS ($T_C = 25^\circ\text{C}$ unless otherwise noted)

Characteristic	Symbol	Min	Typ	Max	Unit
----------------	--------	-----	-----	-----	------

OFF CHARACTERISTICS (1)

Zero Gate Voltage Drain Leakage Current ($V_{DS} = 65\text{ Vdc}$, $V_{GS} = 0\text{ Vdc}$)	I_{DSS}	—	—	10	μAdc
Zero Gate Voltage Drain Leakage Current ($V_{DS} = 28\text{ Vdc}$, $V_{GS} = 0$)	I_{DSS}	—	—	1	μAdc
Gate–Source Leakage Current ($V_{GS} = 5\text{ Vdc}$, $V_{DS} = 0\text{ Vdc}$)	I_{GSS}	—	—	1	μAdc

ON CHARACTERISTICS (1)

Gate Threshold Voltage ($V_{DS} = 10\text{ Vdc}$, $I_D = 200\ \mu\text{Adc}$)	$V_{GS(th)}$	2.5	2.8	3.5	Vdc
Gate Quiescent Voltage ($V_{DS} = 28\text{ Vdc}$, $I_D = 800\text{ mAdc}$)	$V_{GS(Q)}$	—	3.6	—	Vdc
Drain–Source On–Voltage ($V_{GS} = 10\text{ Vdc}$, $I_D = 2\text{ Adc}$)	$V_{DS(on)}$	—	0.26	0.3	Vdc
Forward Transconductance ($V_{DS} = 10\text{ Vdc}$, $I_D = 2\text{ Adc}$)	g_{fs}	—	5	—	S

DYNAMIC CHARACTERISTICS (1)

Reverse Transfer Capacitance ($V_{DS} = 28\text{ Vdc} \pm 30\text{ mV(rms)ac}$ @ 1 MHz, $V_{GS} = 0\text{ Vdc}$)	C_{rss}	—	1.7	—	pF
---	-----------	---	-----	---	----

FUNCTIONAL TESTS (In Motorola Test Fixture, 50 ohm system) (2) 2–carrier W–CDMA, 3.84 MHz Channel Bandwidth Carriers, ACPR and IM3 measured in 3.84 MHz Bandwidth. Peak/Avg. = 8.5 dB @ 0.01% Probability on CCDF.

Common–Source Amplifier Power Gain ($V_{DD} = 28\text{ Vdc}$, $P_{out} = 38\text{ W Avg.}$, $I_{DQ} = 2 \times 800\text{ mA}$, $f_1 = 2112.5\text{ MHz}$, $f_2 = 2122.5\text{ MHz}$ and $f_1 = 2157.5\text{ MHz}$, $f_2 = 2167.5\text{ MHz}$)	G_{ps}	12.5	14	—	dB
Drain Efficiency ($V_{DD} = 28\text{ Vdc}$, $P_{out} = 38\text{ W Avg.}$, $I_{DQ} = 2 \times 800\text{ mA}$, $f_1 = 2112.5\text{ MHz}$, $f_2 = 2122.5\text{ MHz}$ and $f_1 = 2157.5\text{ MHz}$, $f_2 = 2167.5\text{ MHz}$)	η	23	25.5	—	%
Third Order Intermodulation Distortion ($V_{DD} = 28\text{ Vdc}$, $P_{out} = 38\text{ W Avg.}$, $I_{DQ} = 2 \times 800\text{ mA}$, $f_1 = 2112.5\text{ MHz}$, $f_2 = 2122.5\text{ MHz}$ and $f_1 = 2157.5\text{ MHz}$, $f_2 = 2167.5\text{ MHz}$; IM3 measured over 3.84 MHz BW @ $f_1 - 10\text{ MHz}$ and $f_2 + 10\text{ MHz}$ referenced to carrier channel power.)	IM3	—	–37.5	–35	dBc
Adjacent Channel Power Ratio ($V_{DD} = 28\text{ Vdc}$, $P_{out} = 38\text{ W Avg.}$, $I_{DQ} = 2 \times 800\text{ mA}$, $f_1 = 2112.5\text{ MHz}$, $f_2 = 2122.5\text{ MHz}$ and $f_1 = 2157.5\text{ MHz}$, $f_2 = 2167.5\text{ MHz}$; ACPR measured over 3.84 MHz BW @ $f_1 - 5\text{ MHz}$ and $f_2 + 5\text{ MHz}$.)	ACPR	—	–41	–38	dBc
Input Return Loss ($V_{DD} = 28\text{ Vdc}$, $P_{out} = 38\text{ W Avg.}$, $I_{DQ} = 2 \times 800\text{ mA}$, $f_1 = 2112.5\text{ MHz}$, $f_2 = 2122.5\text{ MHz}$ and $f_1 = 2157.5\text{ MHz}$, $f_2 = 2167.5\text{ MHz}$)	IRL	—	–14	–9	dB

(1) Each side of device measured separately. Part is internally matched both on input and output.

(2) Measurements made with device in push–pull configuration.

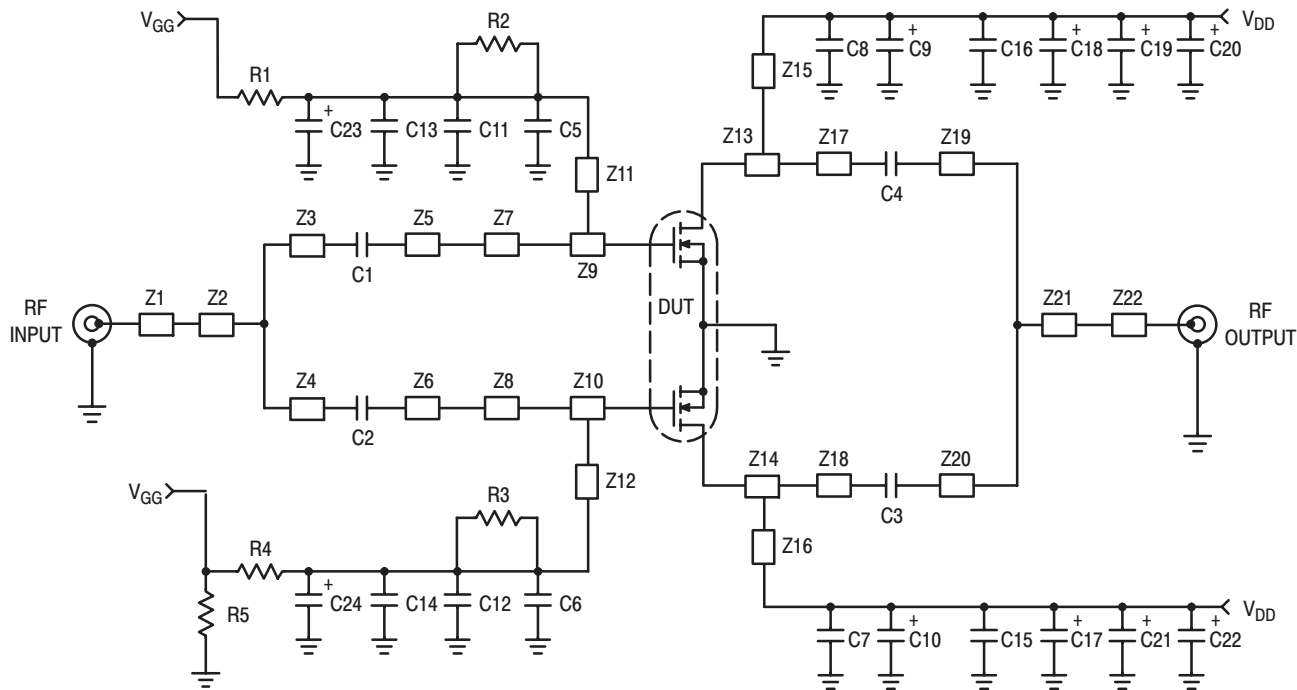

Z1, Z22	1.000" x 0.066" Microstrip	Z9, Z10	0.256" x 0.650" Microstrip
Z2, Z21	0.760" x 0.113" Microstrip	Z11, Z12	1.030" x 0.035" Microstrip
Z3, Z20	0.068" x 0.066" Microstrip	Z13, Z14	0.500" x 0.650" Microstrip
Z4, Z19	1.672" x 0.066" Microstrip	Z15, Z16	0.550" x 0.058" Microstrip
Z5, Z6	0.318" x 0.066" Microstrip	Z17, Z18	0.353" x 0.066" Microstrip
Z7, Z8	0.284" x 0.180" Microstrip	PCB	Taconic RF-35, 0.76 mm, $\epsilon_r = 3.5$

Figure 1. MRF5P21180 Test Circuit Schematic

Table 1. MRF5P21180 Test Circuit Component Designations and Values

Part	Description	Value, P/N or DWG	Manufacturer
C1, C2, C3, C4	30 pF Chip Capacitors	100B300JCA500X	ATC
C5, C6, C7, C8	5.6 pF Chip Capacitors	100B5R6JCA500X	ATC
C9, C10	10 μ F Tantalum Capacitors	T495X106K035AS4394	Kemet
C11, C12	1000 pF Chip Capacitors	100B102JCA500X	ATC
C13, C14, C15, C16	0.1 μ F Chip Capacitors	CDR33BX104AKWS	Kemet
C17, C18, C19, C20, C21, C22	22 μ F Tantalum Capacitors	T491X226K035AS4394	Kemet
C23, C24	1.0 μ F Tantalum Capacitors	T491C105M050	Kemet
R1, R2, R3, R4	10 Ω , 1/8 W Chip Resistors		
R5	1.0 k Ω , 1/8 W Chip Resistor		
WB1, WB2, WB3, WB4	Wear Blocks	5 x 180 x 500 mil Brass Shim	Motorola

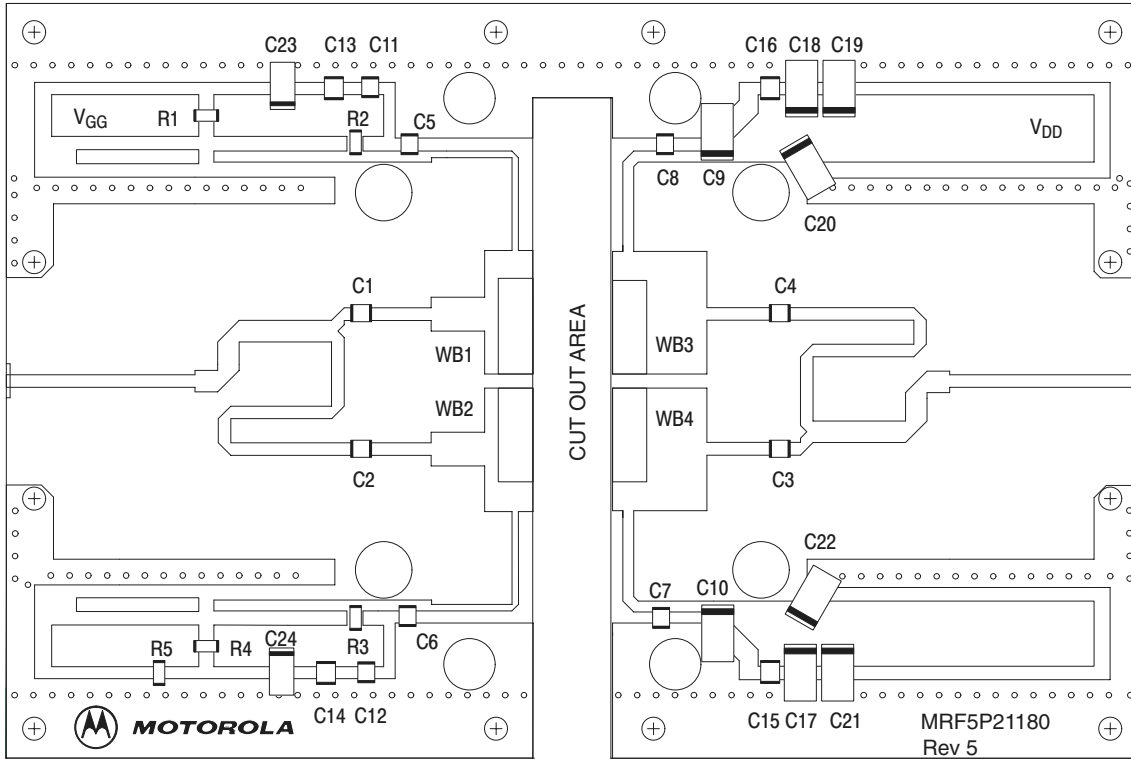

Figure 2. MRF5P21180 Test Circuit Component Layout

TYPICAL CHARACTERISTICS

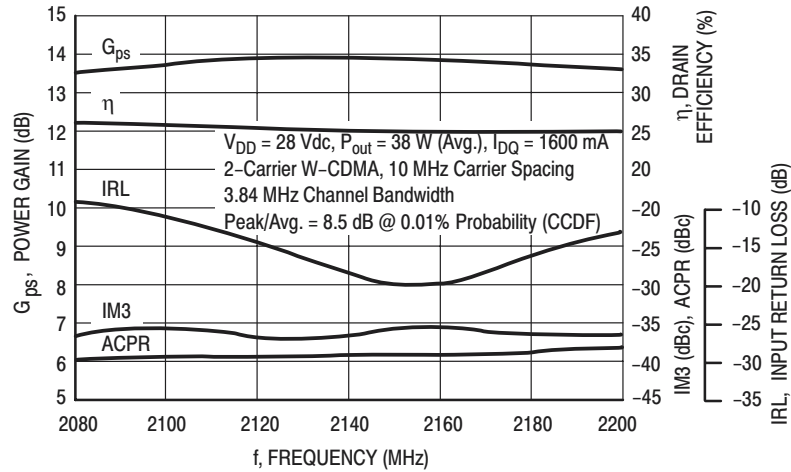

Figure 3. 2-Carrier W-CDMA Broadband Performance

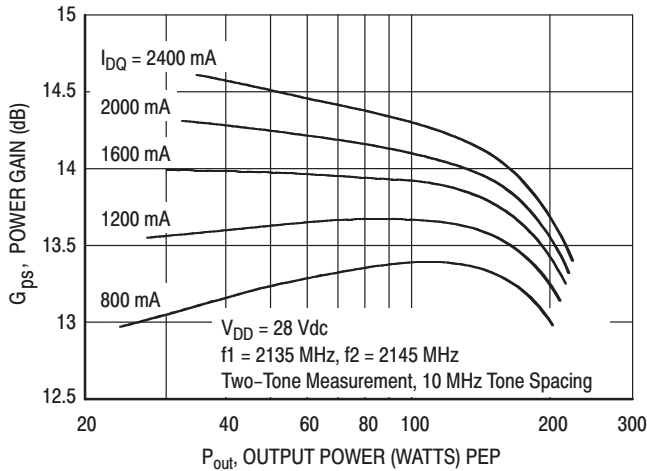

Figure 4. Two-Tone Power Gain versus Output Power

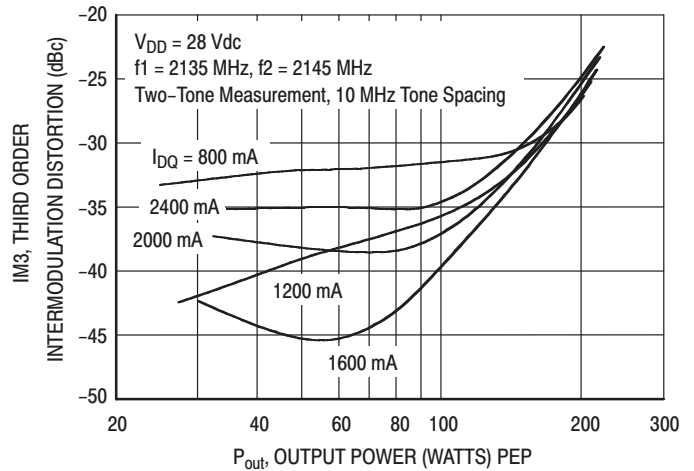

Figure 5. Third Order Intermodulation Distortion versus Output Power

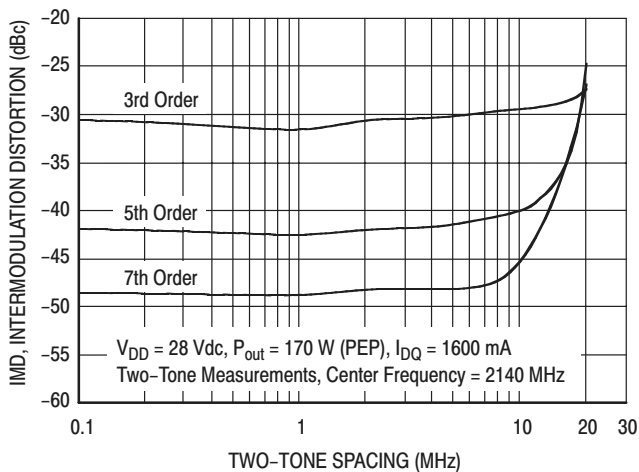

Figure 6. Intermodulation Distortion Products versus Tone Spacing

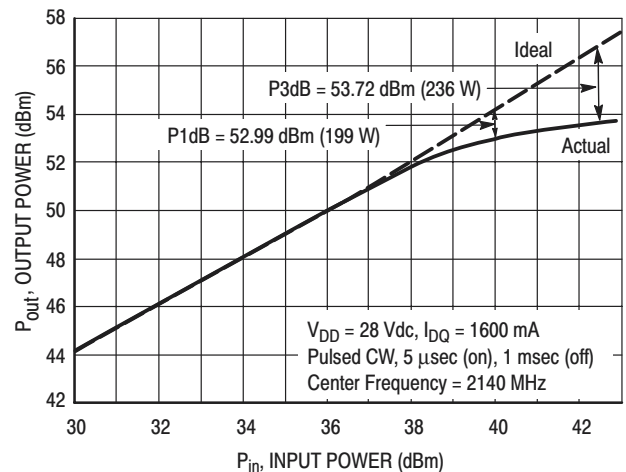

Figure 7. Pulse CW Output Power versus Input Power

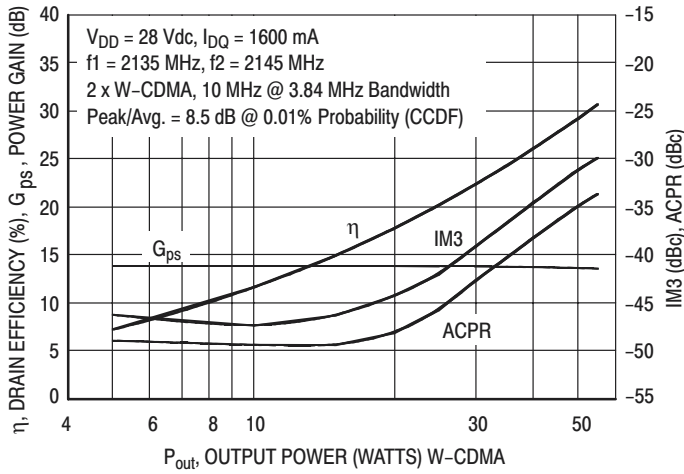

Figure 8. 2-Carrier W-CDMA ACPR, IM3, Power Gain and Drain Efficiency versus Output Power

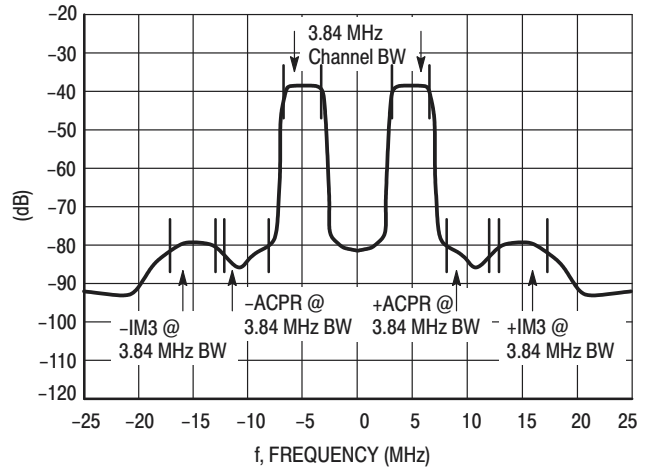

Figure 9. 2-Carrier W-CDMA Spectrum

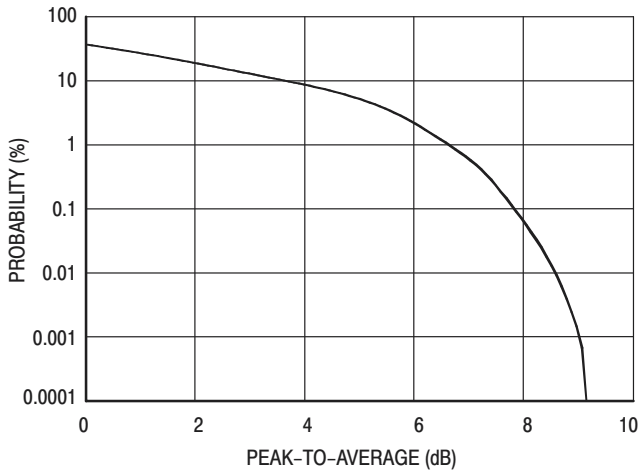
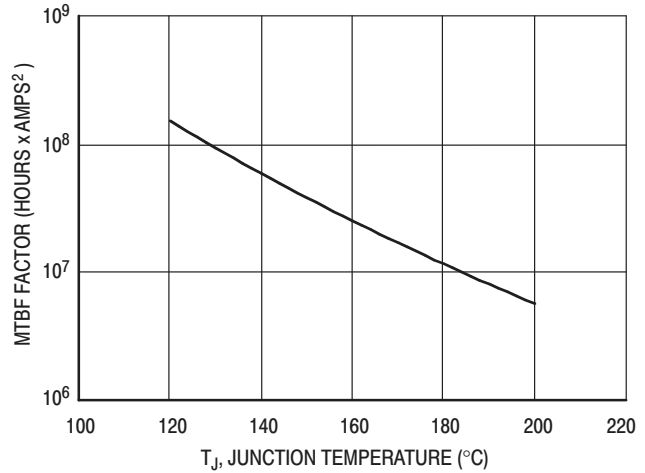
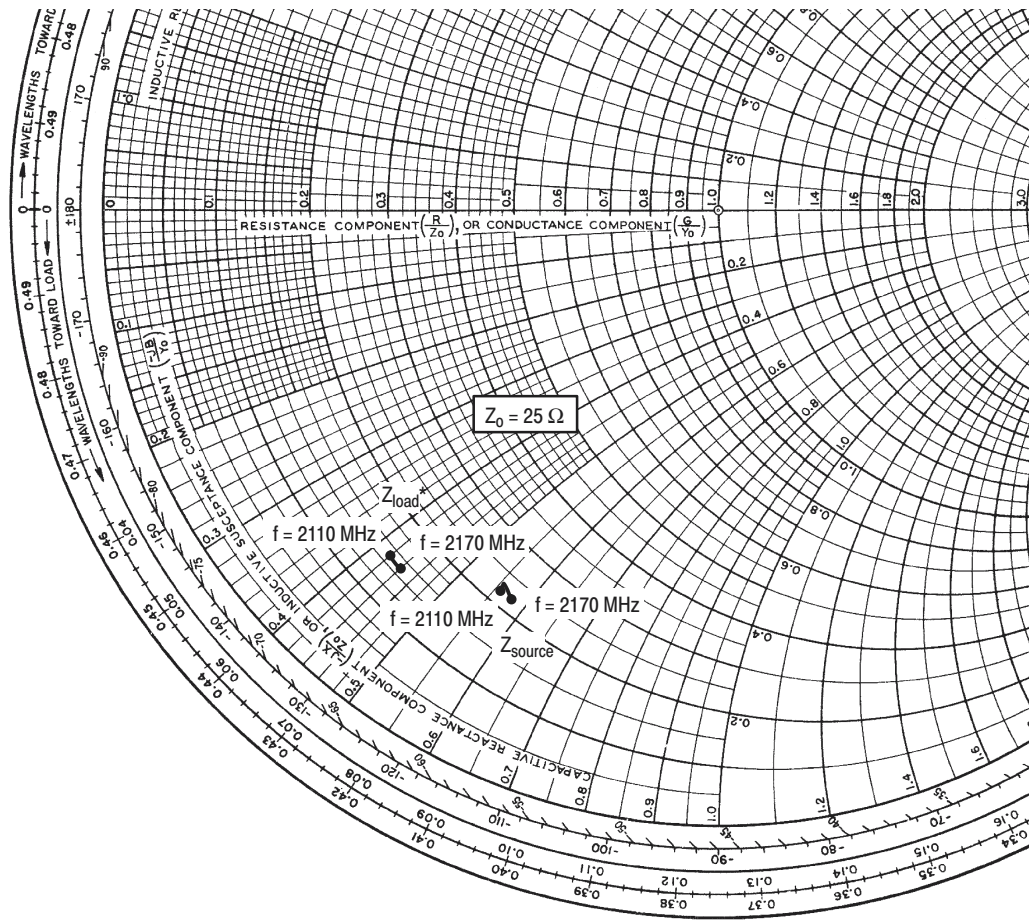

Figure 10. CCDF W-CDMA 3GPP, Test Model 1, 64 DPCH, 67% Clipping, Single Carrier Test Signal



This above graph displays calculated MTBF in hours x ampere² drain current. Life tests at elevated temperatures have correlated to better than $\pm 10\%$ of the theoretical prediction for metal failure. Divide MTBF factor by I_D^2 for MTBF in a particular application.

Figure 11. MTBF Factor versus Junction Temperature



$V_{DD} = 28\text{ V}$, $I_{DQ} = 2 \times 800\text{ mA}$, $P_{out} = 38\text{ W Avg.}$

f MHz	Z_{source} Ω	Z_{load} Ω
2110	$5.39 - j13.89$	$3.69 - j10.51$
2140	$5.66 - j13.99$	$3.81 - j10.66$
2170	$5.53 - j14.51$	$3.79 - j11.05$

Z_{source} = Test circuit impedance as measured from gate to gate, balanced configuration.

Z_{load} = Test circuit impedance as measured from drain to drain, balanced configuration.

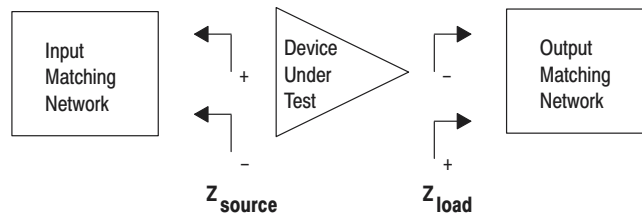
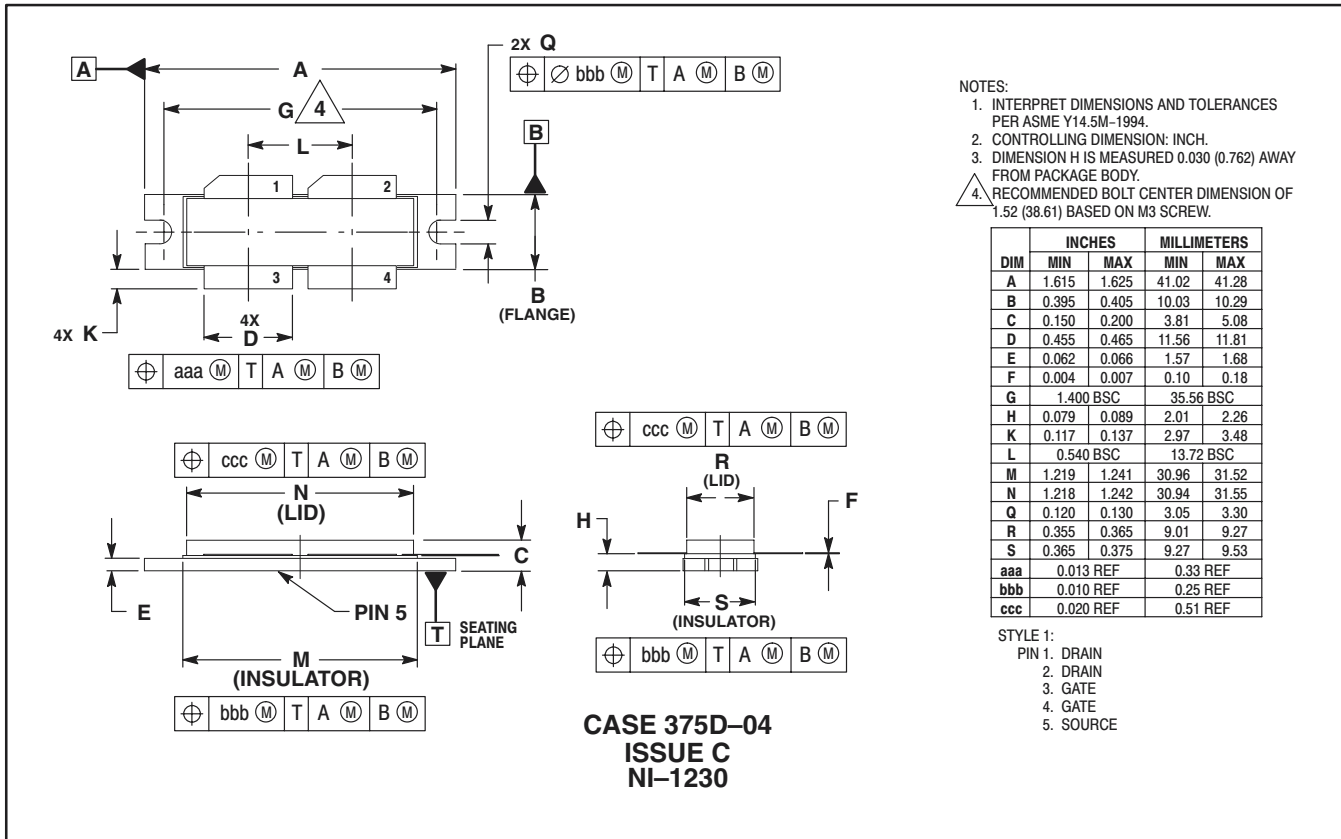

Figure 12. Series Equivalent Input and Output Impedance

PACKAGE DIMENSIONS



Motorola reserves the right to make changes without further notice to any products herein. Motorola makes no warranty, representation, or guarantee regarding the suitability of its products for any particular purpose, nor does Motorola assume any liability arising out of the application or use of any product or circuit, and specifically disclaims any and all liability, including without limitation consequential or incidental damages. "Typical" parameters can and do vary in different applications and actual performance may vary over time. All operating parameters, including "Typicals", must be validated for each customer application by customer's technical experts. Motorola does not convey any license under its patent rights nor the rights of others. Motorola products are not designed, intended, or authorized for use as components in systems intended for surgical implant into the body, or other applications intended to support or sustain life, or for any other application in which the failure of the Motorola product could create a situation where personal injury or death may occur. Should Buyer purchase or use Motorola products for any such unintended or unauthorized application, Buyer shall indemnify and hold Motorola and its officers, employees, subsidiaries, affiliates, and distributors harmless against all claims, costs, damages, and expenses, and reasonable attorney fees arising out of, directly or indirectly, any claim of personal injury or death associated with such unintended or unauthorized use, even if such claim alleges that Motorola was negligent regarding the design or manufacture of the part. Motorola and the Stylized M Logo are registered in the US Patent & Trademark Office. All other product or service names are the property of their respective owners. Motorola, Inc. is an Equal Opportunity/Affirmative Action Employer.

© Motorola, Inc. 2002.

How to reach us:

USA/EUROPE/Locations Not Listed: Motorola Literature Distribution; P.O. Box 5405, Denver, Colorado 80217. 1-303-675-2140 or 1-800-441-2447

JAPAN: Motorola Japan Ltd.; SPS, Technical Information Center, 3-20-1, Minami-Azabu. Minato-ku, Tokyo 106-8573 Japan. 81-3-3440-3569

ASIA/PACIFIC: Motorola Semiconductors H.K. Ltd.; Silicon Harbour Centre, 2 Dai King Street, Tai Po Industrial Estate, Tai Po, N.T. Hong Kong. 852-26668334

Technical Information Center: 1-800-521-6274

HOME PAGE: <http://www.motorola.com/semiconductors/>

