

NUMBER 178802

METRIC

PRINT DIST
単位: 寸法 DIMENSIONS IN MM. DO NOT SCALE PRINT

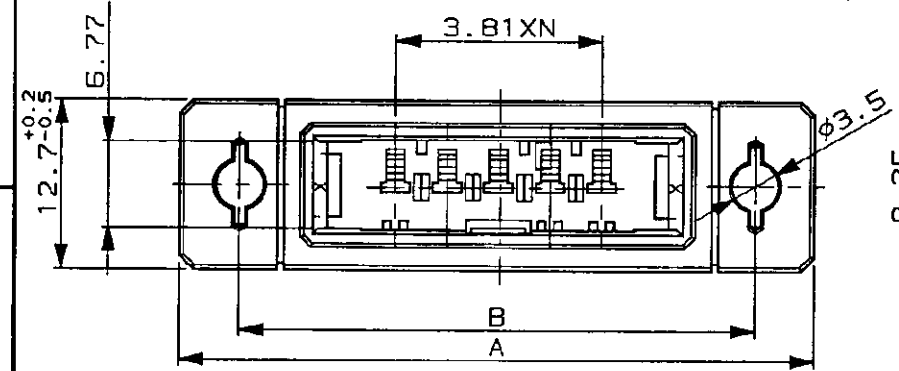
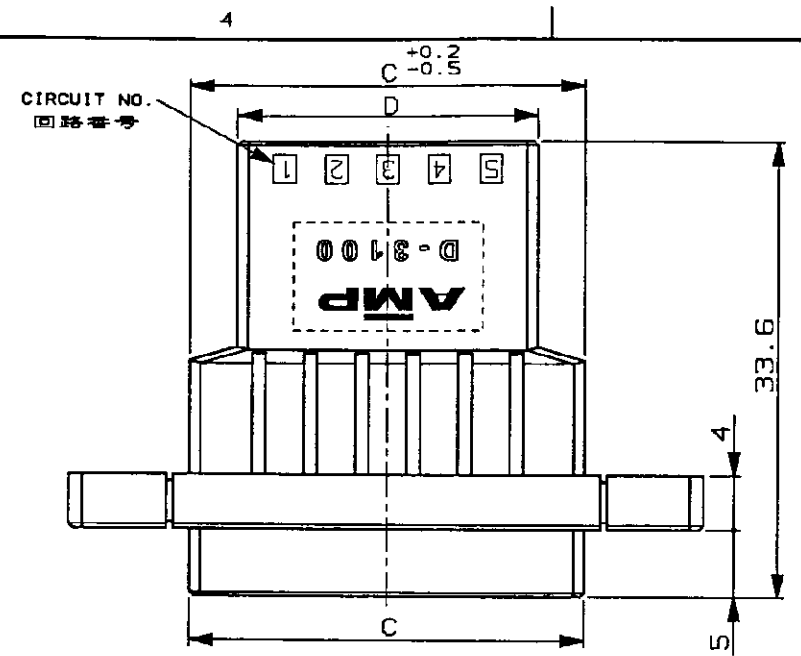

キータイプ X
KEY TYPE X
1-178802-5, -7, -8

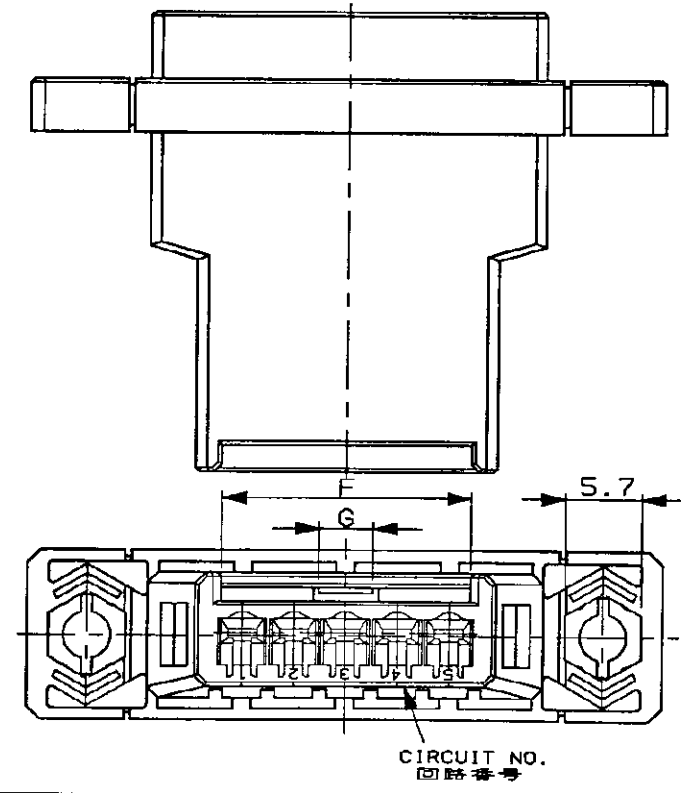

CIRCUIT NO.
回路番号

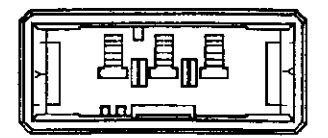

Y キーイングパターン
Y KEYING PATTERN
2-178802-3 ONLY

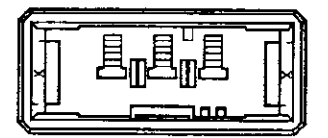

X キーイングパターン
X KEYING PATTERN
1-178802-3 ONLY

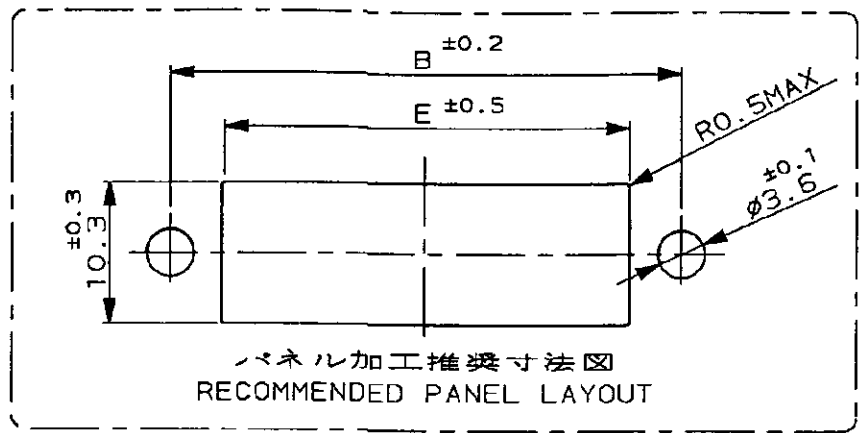
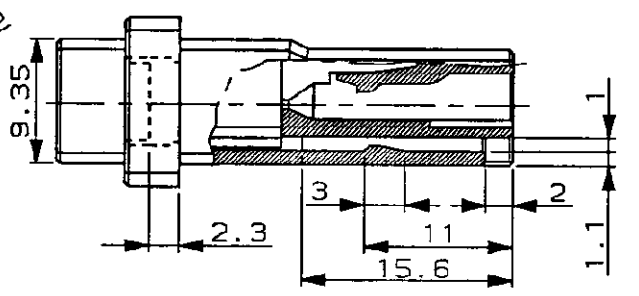

パネル加工推奨寸法図
RECOMMENDED PANEL LAYOUT

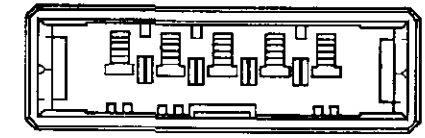

キータイプ Y
KEY TYPE Y
2-178802-8

NOTES

1 MATERIAL: GLASS FIBER THERMO PLASTIC, POLYESTER
COLOR: BLACK

注記

1 材料: ガラス入り熱可塑性ポリエステル樹脂
色: 黒色

キータイプ KEY TYPE	POS. 個数	寸法 DIMENSION	A	B	C	D	E	F	G	N	型番 PART NUMBER
Y	10		67	58	48.29	41.29	49.2	18.4	4	9	2-▲-8
X	10		67	58	48.29	41.29	49.2	18.4	4	9	1--8
X	8		59	50	40.67	33.67	41.6	18.4	4	7	1--7
X	5		47	38	29.24	22.24	30.2	18.4	4	4	1--5
Y	3		40	31	21.62	14.62	22.6	8.4	2	2	2--3
X	3		40	31	21.62	14.62	22.6	8.4	2	2	1-178802-3

Copyright © 1992 年 AMP (Japan), LTD. ALL RIGHTS RESERVED.		Copyright © 1992 年 AMP (Japan), LTD. ALL RIGHTS RESERVED.		AMP 東京エー・エム・ピー株式会社 Tokyo, Japan	
C REVISED (FJ00-3700-95) K.I. Y.J.	24/10	社外電線範囲 (WIRE RANGE)	絶縁外径 (INSULATION DIA.)	名称 (NAME) パネルマウントタイプ タブハウジング ダイナミック 3100 シリーズ用 WIRE TO WIRE PANEL MOUNT TYPE TAB HSG FOR DYNAMIC 3100 (SINGLE ROW)	
B1 REVISED (FJ00-2011-95) NM S.M.	3/30 '95	材料 (MATERIAL)	仕上 (FINISH)	一般公差 (GENERAL TOLERANCE)	SIZE LOC 番号 (No.)
B REVISED (FJ00-0885-94) K.I. S.M.	9/27 '94	注記参照 SEE NOTES		10mm以下: ±0.2 10mm以上 30mm以下: ±0.25 30mm以上 100mm以下: ±0.3 角: ±0.3	B J 178802
A REVISED (J-1120) Y.T. S.M.	2/8 '93	DR. 9 MAR 92 N. Matsubara	DE. 9 MAR 92 N. Matsubara	尺座 (SCALE)	REV. SHEET
O RELEASED (J-1008) NM S.M.	3-10 '92	CHK. 10 MAR '92 H. OBATA	APP. 10 MAR '92 S. MANABE	2/1	C 1 OF 1
LTR 変更 (REVISION RECORD)	DR	CHK	DATE		