



TWO HOLE HYLUG™ CODE CONDUCTOR LONG BARREL WITH INSPECTION WINDOW

TYPES YAZ-2N, YAZ-2TC

UL LISTED 90° C,
600 VOLT TO 35 KV ◆

C-54

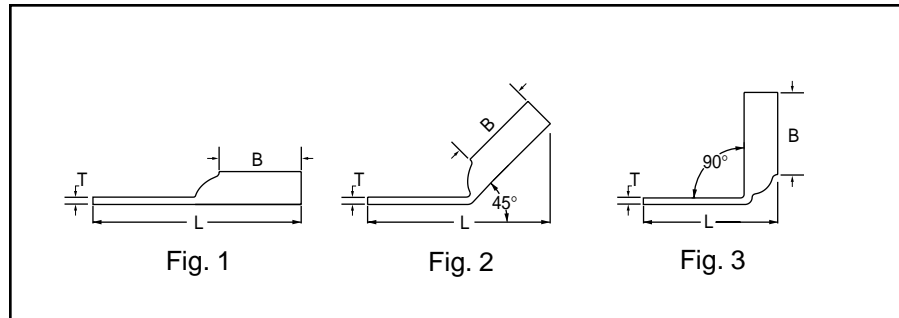
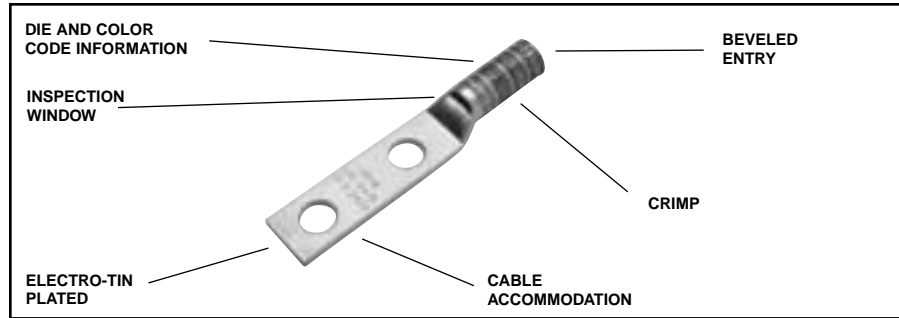

Catalog Number	Fig #	Conductor		Stud Hole Size	Stud Hole Spacing	Tongue Width	Figure Dimensions			Dieless (# of crimps)	▲ Installation Tooling					Wire Strip Length					
		AWG	MM ²				(B)	(T)	(L)		Mechanical MD6, OUR840 MD7-34R	Hydraulic		Color Code	Die Index						
												BCT500HS Y500CTHS	Y35, Y39, Y750 Y46, BAT35, BAT750								
YAZV10-2TC14	1	14-10 AWG	6	1/4"	5/8"	.41"	.69"	.05"	Y8MRB-1 (2)	-	-	-	-	-	-	3/4"					
YAZV10-2TC14-45	2																1/4"	3/4"	.41"	.69"	.05"
YAZV10-2TC14-90	3																				
YAZV10-2TC14E2	1			1/4"	3/4"	.41"	.69"	.05"													
YAZV10-2TC14E2-45	2																				
YAZV10-2TC14E2-90	3																				
YAZ8C-2TC10	1	#8 STR	†	#10	5/8"	.41"	.75"	.08"	Y1MR (2) Y8MRB-1 (2) Y2MR (2) MY29-3 (2) MY29-11 (2) MRC840 (2)	W8CVT (2) W8CRT (2) X8CRT (2)	W8CVT (2) W8CRT (2) X8CRT (2)	U8CRT (2)	Red	49	7/8"						
YAZ8C-2TC10-45	2															1/4"	5/8"	.44"	.75"	.08"	
YAZ8C-2TC10-90	3																				
YAZ8C-2TC10E2	1			1/4"	5/8"	.44"	.75"	.08"													
YAZ8C-2TC10E2-45	2																				
YAZ8C-2TC10E2-90	3																				
YAZ8C-2TC14	1			#6 SOL	10	1/4"	5/8"	.44"								.75"	.08"				
YAZ8C-2TC14-45	2																				
YAZ8C-2TC14-90	3																				
YAZ8C-2TC14E2	1					1/4"	3/4"	.44"								.75"	.08"				
YAZ8C-2TC14E2-45	2																				
YAZ8C-2TC14E2-90	3																				
YAZ8C-2TC14E1	1	1/4"	1"	.44"	.75"	.08"															
YAZ8C-2TC14E1-45	2																				
YAZ8C-2TC14E1-90	3																				
YAZ8C-2TC38	1	3/8"	1"	.58"	.75"	.06"															
YAZ8C-2TC38-45	2																				
YAZ8C-2TC38-90	3																				
YAZ6C-2N	1	#6 AWG	-	1/2"	1-3/4"	.83"	1.12"	.12"	Y2MR (2) MY29-3 (2) MY29-11 (2) MRC840 (2) Y644M (1) Y1MR (2)	W5CVT (2) W5CRT (2) X5CRT (2) X8CART (2)	W5CVT (2) X5CRT (2) X5CRT (2) X8CART (2)	U5CRT (2) U8CART (2)	Blue	7 or 374	1-1/16"						
YAZ6C-2N-45	2																				
YAZ6C-2N-90	3																				
YAZ6C-2TC10E2	1			1/2"	1-3/4"	.83"	1.12"	.12"													
YAZ6C-2TC10E2-45	2																				
YAZ6C-2TC10E2-90	3																				

▲ See tooling section of this catalog for complete tool and die listings.
 * Use P-UADP-1 adaptor with "U" -dies in Y46 HYPRESS™.
 ** P-RT die sets for use in Y46 HYPRESS™ only, P-UADP-1 adaptor not required.
 *** The MM² conductor sizes listed are the recommendations for Class 2 conductor.
 † The MM² conductor size referred to here is for Class 2 and Class 5 conductor.
 ‡ Available undrilled. Add suffix "U" to catalog number (example: YA25U).
 ◆ For applications greater than 2000 Volts consult cable manufacturer for voltage stress relief instructions.



TWO HOLE HYLUG™ CODE CONDUCTOR LONG BARREL WITH INSPECTION WINDOW (CONTINUED)

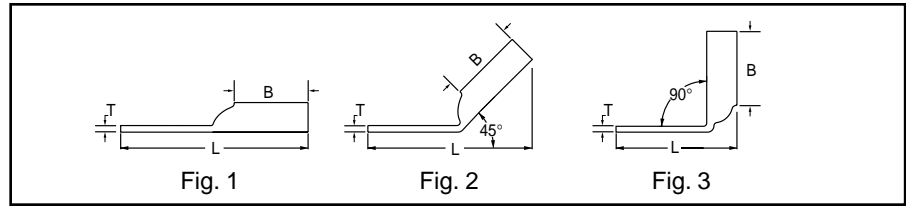

Catalog Number	Fig #	Conductor		Stud Hole Size	Stud Hole Spacing	Tongue Width	Figure Dimensions			Dieless (# of crimps)	▲ Installation Tooling				Wire Strip Length																												
		AWG	MM ²				(B)	(T)	(L)		Mechanical		Hydraulic			Color Code	Die Index																										
											MD6, OUR840 MD7-34R	BCT500HS Y500CTHS	Y35, Y39, Y750 Y46, BAT35, BAT750																														
YAZ6C-2TC14	1	#6 AWG	-	1/4"	5/8"	.45"	1.12"	.08"	2.65"	Y1MR (2) Y2MR (2) MY29-3 (2) MY29-11 (2) MRC840 (2) Y644M (2)	W5CVT (2) W5CRT (2) X5CRT (2) X8CART (2)	W5CVT (2) X5CRT (2) X5CRT (2) X8CART (2)	U5CRT (2) U8CABT (2)	Blue	7 or 374	1-1/16"																											
YAZ6C-2TC14-45	2						1.12"	.08"	2.45"																																		
YAZ6C-2TC14-90	3								1.51"																																		
YAZ6C-2TC14E2	1			1/4"	3/4"	.45"	1.12"	.08"	2.78"																																		
YAZ6C-2TC14E2-45	2						1.12"	.08"	2.58"																																		
YAZ6C-2TC14E2-90	3								1.63"																																		
YAZ6C-2TC14E1	1			1/4"	1"	.45"	1.12"	.08"	3.03"																																		
YAZ6C-2TC14E1-45	2						1.12"	.08"	2.83"																																		
YAZ6C-2TC14E1-90	3								1.63"																																		
YAZ6C-2TC38E2	1			3/8"	3/4"	.58"	1.12"	.06"	2.97"																																		
YAZ6C-2TC38E2-45	2						1.12"	.06"	2.72"																																		
YAZ6C-2TC38E2-90	3								1.81"																																		
YAZ6C-2TC38E6	1			3/8"	7/8"	.58"	1.12"	.06"	3.09"																																		
YAZ6C-2TC38E6-45	2						1.12"	.06"	2.85"																																		
YAZ6C-2TC38E6-90	3								1.94"																																		
YAZ6C-2TC38	1	3/8"	1"	.58"	1.12"	.06"	3.22"																																				
YAZ6C-2TC38-45	2				1.12"	.06"	2.97"																																				
YAZ6C-2TC38-90	3						2.06"																																				
YAZ5C-2N	1	#5 AWG	-	1/2"	1-3/4"	.83"	1.12"	.12"	4.43"	W5CRT (2) W5CVT (2) X5CRT (2)	W5CVT (2) W5CRT (2) X5CRT (2)	U5CRT (2)	Blue	7 or 374	1/16"																												
YAZ5C-2N-45	2						1.12"	.12"	4.31"																																		
YAZ5C-2N-90	3								3.28"																																		
YAZ4C-2N	1	#4 AWG	-	1/2"	1-3/4"	.83"	1.12"	.12"	4.42"							W4CVT (2) W4CRT (2) X4CRT (2)	W4CVT (2) W4CRT (2) X4CRT (2)	U4CRT (2) U6CABT (2)	Gray	8 or 346	1-1/16"																						
YAZ4C-2N-45	2						1.12"	.12"	4.30"																																		
YAZ4C-2N-90	3								3.30"																																		
YAZ4C-2TC10-E2	1			#10	3/4"	.49"	1.12"	.09"	2.67"													Y1MR (4) Y2MR (4) MY29-3 (2) MY29-11 (2) MRC840 (2) Y644M (2)	W3CRT (2)	W3CRT (2)	U3CRT (2)	White	9	1-5/16"															
YAZ4C-2TC10-E245	2						1.12"	.09"	2.49"																																		
YAZ4C-2TC10-E290	3								1.54"																																		
YAZ4C-2TC14	1			1/4"	5/8"	.49"	1.12"	.09"	2.67"																				Y1MR (4) Y2MR (4) MY29-3 (2) MY29-11 (2) MRC840 (2) Y644M (2)	W3CRT (2)	W3CRT (2)	U3CRT (2)	White	9	1-5/16"								
YAZ4C-2TC14-45	2						1.12"	.09"	2.49"																																		
YAZ4C-2TC14-90	3								1.54"																																		
YAZ4C-2TC14E2	1			1/4"	3/4"	.49"	1.12"	.09"	2.80"																											Y1MR (4) Y2MR (4) MY29-3 (2) MY29-11 (2) MRC840 (2) Y644M (2)	W3CRT (2)	W3CRT (2)	U3CRT (2)	White	9	1-5/16"	
YAZ4C-2TC14E2-45	2						1.12"	.09"	2.61"																																		
YAZ4C-2TC14E2-90	3								1.66"																																		
YAZ4C-2TC38	1			3/8"	1"	.58"	1.12"	.08"	3.23"	Y1MR (4) Y2MR (4) MY29-3 (2) MY29-11 (2) MRC840 (2) Y644M (2)	W3CRT (2)	W3CRT (2)	U3CRT (2)	White	9																												1-5/16"
YAZ4C-2TC38-45	2						1.12"	.08"	3.01"																																		
YAZ4C-2TC38-90	3								2.09"																																		
YAZ3C-2N	1	#3 AWG	25	1/2"	1-3/4"	.83"	1.25"	.12"	4.58"							W3CRT (2)	W3CRT (2)	U3CRT (2)	White	9	1-5/16"																						
YAZ3C-2N-45	2						1.25"	.12"	4.41"																																		
YAZ3C-2N-90	3								3.32"																																		
YAZ3C-2TC14	1			1/4"	5/8"	.55"	1.25"	.09"	2.83"													W3CRT (2)	W3CRT (2)	U3CRT (2)	White	9	1-5/16"																
YAZ3C-2TC14-45	2						1.25"	.09"	2.59"																																		
YAZ3C-2TC14-90	3								1.55"																																		
YAZ3C-2TC14E2	1			1/4"	3/4"	.55"	1.25"	.09"	2.95"																			W3CRT (2)	W3CRT (2)	U3CRT (2)	White	9	1-5/16"										
YAZ3C-2TC14E2-45	2						1.25"	.09"	2.72"																																		
YAZ3C-2TC14E2-90	3								1.68"																																		
YAZ3C-2TC38E2	1			3/8"	3/4"	.58"	1.25"	.08"	3.14"																									W3CRT (2)	W3CRT (2)	U3CRT (2)	White	9	1-5/16"				
YAZ3C-2TC38E2-45	2						1.25"	.08"	2.88"																																		
YAZ3C-2TC38E2-90	3								1.86"																																		

C-55

▲ See tooling section of this catalog for complete tool and die listings.
 * Use P-UADP-1 adaptor with "U" -dies in Y46 HYPRESS™.
 ** P-RT die sets for use in Y46 HYPRESS™ only, P-UADP-1 adaptor not required.

*** The MM² conductor sizes listed are the recommendations for Class 2 conductor.
 * Available undrilled. Add suffix "U" to catalog number (example: YA25U).

◆ For applications greater than 2000 Volts consult cable manufacturer for voltage stress relief instructions.



TWO HOLE HYLUG™ CODE CONDUCTOR LONG BARREL WITH INSPECTION WINDOW (CONTINUED)

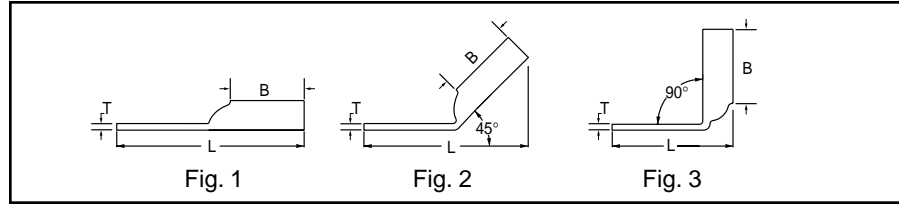

C-56

Catalog Number	Fig #	Conductor		Stud Hole Size	Stud Hole Spacing	Tongue Width	Figure Dimensions			Dieless (# of crimps)	▲ Installation Tooling					Wire Strip Length																					
		AWG	MM ²				(B)	(T)	(L)		Mechanical		Hydraulic		Color Code		Die Index																				
											MD6, OUR840 MD7-34R	BCT500HS Y500CTHS	Y35, Y39, Y750 Y46, BAT35, BAT750																								
YAZ3C-2TC38	1	#3 AWG #2 SOL	25	3/8"	1"	.58"	1.25"	.08"	3.39"	Y1MR (4) Y2MR (4) MY29-3 (2) MY29-11 (2) MRC840 (2) Y644M (1)	W3CRT (2)	W3CRT (2)	U3CRT (2)	White	9	1-5/16"																					
YAZ3C-2TC38-45	2						1.25"	.08"	3.13"																												
YAZ3C-2TC38-90	3						1.25"	.08"	2.11"																												
YAZ2C-2N	1	#2 AWG	35	1/2"	1-3/4"	.83"	1.25"	.12"	4.60"	W2CVT (2) W2CRT (2) X2CRT (2)	W2CVT (2) W2CRT (2) X2CRT (2)	U2CRT (2)	Brown	10	1-5/16"																						
YAZ2C-2N-45	2						1.25"	.12"	4.32"																												
YAZ2C-2N-90	3						1.25"	.12"	3.32"																												
YAZ2C-2TC10E2	1			#10	3/4"	.60"	1.25"	.11"	2.85"							Y1MR (4) Y2MR (4) MY29-3 (2) MY29-11 (2) MRC840 (2) Y644M (1)	W2CVT (2) W2CRT (2) X2CRT (2)	W2CVT (2) W2CRT (2) X2CRT (2)	U2CRT (2)	Brown	10	1-5/16"															
YAZ2C-2TC10E2-45	2						1.25"	.11"	2.65"																												
YAZ2C-2TC10E2-90	3						1.25"	.11"	1.58"																												
YAZ2C-2TC14	1			1/4"	5/8"	.60"	1.25"	.11"	2.85"							Y1MR (4) Y2MR (4) MY29-3 (2) MY29-11 (2) MRC840 (2) Y644M (1)	W2CVT (2) W2CRT (2) X2CRT (2)	W2CVT (2) W2CRT (2) X2CRT (2)	U2CRT (2)	Brown	10	1-5/16"															
YAZ2C-2TC14-45	2						1.25"	.11"	2.65"																												
YAZ2C-2TC14-90	3						1.25"	.11"	1.58"																												
YAZ2C-2TC14E2	1			1/4"	3/4"	.60"	1.25"	.11"	2.97"							Y1MR (4) Y2MR (4) MY29-3 (2) MY29-11 (2) MRC840 (2) Y644M (1)	W2CVT (2) W2CRT (2) X2CRT (2)	W2CVT (2) W2CRT (2) X2CRT (2)	U2CRT (2)	Brown	10	1-5/16"															
YAZ2C-2TC14E2-45	2						1.25"	.11"	2.77"																												
YAZ2C-2TC14E2-90	3						1.25"	.11"	1.71"																												
YAZ2C-2TC14E1	1	1/4"	1"	.60"	1.25"	.11"	3.22"	Y1MR (4) Y2MR (4) MY29-3 (2) MY29-11 (2) MRC840 (2) Y644M (1)	W2CVT (2) W2CRT (2) X2CRT (2)	W2CVT (2) W2CRT (2) X2CRT (2)	U2CRT (2)	Brown	10	1-5/16"																							
YAZ2C-2TC14E1-45	2				1.25"	.11"	3.02"																														
YAZ2C-2TC14E1-90	3				1.25"	.11"	1.96"																														
YAZ2C-2TC516E2	1	#2 AWG	35	5/16"	3/4"	.60"	1.25"	.11"	3.03"	Y1MR (4) Y2MR (4) MY29-3 (2) MY29-11 (2) MRC840 (2) Y644M (1)	W2CVT (2) W2CRT (2) X2CRT (2)	W2CVT (2) W2CRT (2) X2CRT (2)	U2CRT (2)	Brown	10	1-5/16"																					
YAZ2C-2TC516E2-45	2						1.25"	.11"	2.84"																												
YAZ2C-2TC516E2-90	3						1.25"	.11"	1.77"																												
YAZ2C-2TC38E2	1			3/8"	3/4"	.60"	1.25"	.11"	3.16"								Y1MR (4) Y2MR (4) MY29-3 (2) MY29-11 (2) MRC840 (2) Y644M (1)	W2CVT (2) W2CRT (2) X2CRT (2)	W2CVT (2) W2CRT (2) X2CRT (2)	U2CRT (2)	Brown	10	1-5/16"														
YAZ2C-2TC38E2-45	2						1.25"	.11"	2.96"																												
YAZ2C-2TC38E2-90	3						1.25"	.11"	1.90"																												
YAZ2C-2TC38E6	1			3/8"	7/8"	.60"	1.25"	.11"	3.28"															Y1MR (4) Y2MR (4) MY29-3 (2) MY29-11 (2) MRC840 (2) Y644M (1)	W2CVT (2) W2CRT (2) X2CRT (2)	W2CVT (2) W2CRT (2) X2CRT (2)	U2CRT (2)	Brown	10	1-5/16"							
YAZ2C-2TC38E6-45	2						1.25"	.11"	3.09"																												
YAZ2C-2TC38E6-90	3						1.25"	.11"	2.02"																												
YAZ2C-2TC38	1			3/8"	1"	.60"	1.25"	.11"	3.41"																						Y1MR (4) Y2MR (4) MY29-3 (2) MY29-11 (2) MRC840 (2) Y644M (1)	W2CVT (2) W2CRT (2) X2CRT (2)	W2CVT (2) W2CRT (2) X2CRT (2)	U2CRT (2)	Brown	10	1-5/16"
YAZ2C-2TC38-45	2						1.25"	.11"	3.21"																												
YAZ2C-2TC38-90	3						1.25"	.11"	2.14"																												
YAZ2C-2NTC38	1	3/8"	1-3/4"	.60"	1.25"	.11"	4.16"	Y1MR (4) Y2MR (4) MY29-3 (2) MY29-11 (2) MRC840 (2) Y644M (1)	W2CVT (2) W2CRT (2) X2CRT (2)	W2CVT (2) W2CRT (2) X2CRT (2)	U2CRT (2)	Brown	10	1-5/16"																							
YAZ2C-2NTC38-45	2				1.25"	.11"	3.96"																														
YAZ2C-2NTC38-90	3				1.25"	.11"	2.90"																														
YAZ1C-2N	1	#1 AWG	50	1/2"	1-3/4"	.83"	1.38"								.12"	4.76"	Y1MR (4) Y2MR (4) MY29-3 (2) MY29-11 (2) MRC840 (2) Y644M (1)	W1CVT (2) W1CRT-1 (2) X1CRT-1 (2)	W1CVT (2) W1CRT-1 (2) X1CRT-1 (2)	U1CRT-1 (2) U4CABT (2)	Green	11 or 375	1-7/16"														
YAZ1C-2N-45	2						1.38"								.12"	4.45"																					
YAZ1C-2N-90	3						1.38"								.12"	3.34"																					
YAZ1C-2TC14	1			1/4"	5/8"	.67"	1.38"								.10"	3.01"								Y1MR (4) Y2MR (4) MY29-3 (2) MY29-11 (2) MRC840 (2) Y644M (1)	W1CVT (2) W1CRT-1 (2) X1CRT-1 (2)	W1CVT (2) W1CRT-1 (2) X1CRT-1 (2)	U1CRT-1 (2) U4CABT (2)	Green	11 or 375	1-7/16"							
YAZ1C-2TC14-45	2						1.38"								.10"	2.75"																					
YAZ1C-2TC14-90	3						1.38"								.10"	1.60"																					
YAZ1C-2TC14E2	1			1/4"	3/4"	.67"	1.38"								.10"	3.13"															Y1MR (4) Y2MR (4) MY29-3 (2) MY29-11 (2) MRC840 (2) Y644M (1)	W1CVT (2) W1CRT-1 (2) X1CRT-1 (2)	W1CVT (2) W1CRT-1 (2) X1CRT-1 (2)	U1CRT-1 (2) U4CABT (2)	Green	11 or 375	1-7/16"
YAZ1C-2TC14E2-45	2						1.38"								.10"	2.87"																					
YAZ1C-2TC14E2-90	3						1.38"								.10"	1.73"																					
YAZ1C-2TC38	1			3/8"	1"	.67"	1.38"	.10"	3.57"	Y1MR (4) Y2MR (4) MY29-3 (2) MY29-11 (2) MRC840 (2) Y644M (1)	W1CVT (2) W1CRT-1 (2) X1CRT-1 (2)	W1CVT (2) W1CRT-1 (2) X1CRT-1 (2)	U1CRT-1 (2) U4CABT (2)	Green	11 or 375	1-7/16"																					
YAZ1C-2TC38-45	2						1.38"	.10"	3.31"																												
YAZ1C-2TC38-90	3						1.38"	.10"	2.16"																												
YAZ25-2N	1	1/0 AWG	-	1/2"	1-3/4"	.83"	1.38"	.11"	4.79"								MY29-3 (2) MY29-11 (2) MRC840 (4) Y644M (1)	W25RT (4) W25VT (4) X25RT (4)	W25VT (4) X25RT (4) W25RT (4)	U25RT (2) U2CABT (2)	Pink	12 or 348	1-7/16"														
YAZ25-2N-45	2						1.38"	.11"	4.52"																												
YAZ25-2N-90	3						1.38"	.11"	3.38"																												

▲ See tooling section of this catalog for complete tool and die listings.

* Use P-UADP-1 adaptor with "U" -dies in Y46 HYPRESS™.

** P-RT die sets for use in Y46 HYPRESS™ only, P-UADP-1 adaptor not required.

*** The MM² conductor sizes listed are the recommendations for Class 2 conductor.

* Available undrilled. Add suffix "U" to catalog number (example: YA25U).

◆ For applications greater than 2000 Volts consult cable manufacturer for voltage stress relief instructions.



TWO HOLE HYLUG™ CODE CONDUCTOR LONG BARREL WITH INSPECTION WINDOW (CONTINUED)

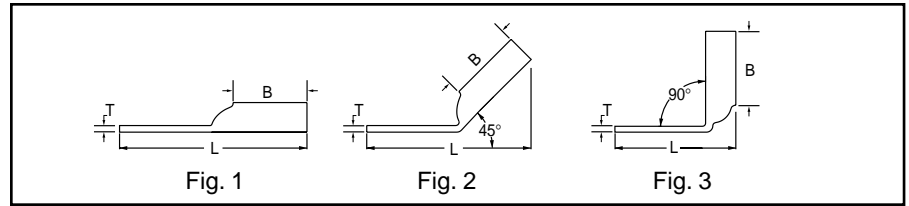

Catalog Number	Fig #	Conductor					▲ Installation Tooling					Wire Strip Length												
		AWG	*** MM ²	Stud Hole Size	Stud Hole Spacing	Tongue Width	Figure Dimensions			Dieless (# of crimps)	Mechanical MD6, OUR840 MD7-34R		Hydraulic		Color Code	Die Index								
							(B)	(T)	(L)				BCT500HS Y500CTHS	Y35, Y39, Y750 Y46, BAT35, BAT750										
YAZ25-2TC14	1	1/0 AWG	-	1/4"	5/8"	.75"	1.38"	.12"	3.04"	W25RT (4) W25VT (4) X25RT (4)	W25VT (4) W25RT (4) W25RT (4)	U25RT (2) U2CABT (2)	Pink	12 or 348	1-7/16"									
YAZ25-2TC14-45	2								2.81"															
YAZ25-2TC14-90	3								1.64"															
YAZ25-2TC14E2	1								3.16"															
YAZ25-2TC14E2-45	2								2.93"															
YAZ25-2TC14E2-90	3								1.76"															
YAZ25-2TC14E1	1			3.41"																				
YAZ25-2TC14E1-45	2			3.18"																				
YAZ25-2TC14E1-90	3			2.01"																				
YAZ25-2TC516E6	1			3.35"																				
YAZ25-2TC516E6-45	2			3.12"																				
YAZ25-2TC516E6-90	3			1.95"																				
YAZ25-2TC516	1			3.47"																				
YAZ25-2TC516-45	2			3.24"																				
YAZ25-2TC516-90	3			2.08"																				
YAZ25-2TC38	1			3.60"																				
YAZ25-2TC38-45	2			3.37"																				
YAZ25-2TC38-90	3			2.20"																				
YAZ25-2NTC38	1	4.35"																						
YAZ25-2NTC38-45	2	4.12"																						
YAZ25-2NTC38-90	3	2.95"																						
YAZ26-2N	1	2/0 AWG	70	1/2"	1 3/4"	.83"	1.50"	.12"	4.95"	MY29-3 (2) MY29-11 (2) MRC840 (4) Y644M (1)	W26VT (4) W26RT (4) X26RT (4)	W26VT (4) W26RT (4) X26RT (4)	U26RT (2)	Black	13	1-9/16"								
YAZ26-2N-45	2								4.67"															
YAZ26-2N-90	3								3.41"															
YAZ26-2TC14	1								3.20"															
YAZ26-2TC14-45	2								2.92"															
YAZ26-2TC14-90	3								1.66"															
YAZ26-2TC14E2	1			3.32"																				
YAZ26-2TC14E2-45	2			3.05"																				
YAZ26-2TC14E2-90	3			1.79"																				
YAZ26-2TC38	1			3.76"																				
YAZ26-2TC38-45	2			3.48"																				
YAZ26-2TC38-90	3			2.22"																				
YAZ27-2N	1			3/0 AWG	-	1/2"	1-3/4"	.91"	1.50"								.13"	4.98"	W27VT (4) W27RT (4) X27RT (6)	W27VT (4) W27RT (4) X27RT (6)	U27RT (2)	Orange	14	1-9/16"
YAZ27-2N-45	2																	4.71"						
YAZ27-2N-90	3																	3.44"						
YAZ27-2TC14E2	1					3.36"																		
YAZ27-2TC14E2-45	2					3.08"																		
YAZ27-2TC14E2-90	3					1.82"																		
YAZ27-2TC38	1	3.80"																						
YAZ27-2TC38-45	2	3.52"																						
YAZ27-2TC38-90	3	2.25"																						
YAZ28-2N	1	4/0 AWG	-	1/2"	1-3/4"	1.02"	1.62"	.14"	5.15"	W28VT (4) W28RT (4) X28RT (6)	W28VT (4) W28RT (4) X28RT (6)	U28RT (2)	Purple	15	1-11/16"									
YAZ28-2N-45	2								4.86"															
YAZ28-2N-90	3								3.48"															
YAZ28-2TC14E2	1			3.55"																				
YAZ28-2TC14E2-45	2			3.25"																				
YAZ28-2TC14E2-90	3			1.86"																				

▲ See tooling section of this catalog for complete tool and die listings.
 * Use P-UADP-1 adaptor with "U" -dies in Y46 HYPRESS™.
 ** P-RT die sets for use in Y46 HYPRESS™ only, P-UADP-1 adaptor not required.

*** The MM² conductor sizes listed are the recommendations for Class 2 conductor.
 * Available undrilled. Add suffix "U" to catalog number (example: YA25U).

◆ For applications greater than 2000 Volts consult cable manufacturer for voltage stress relief instructions.



TWO HOLE HYLUG™ CODE CONDUCTOR LONG BARREL WITH INSPECTION WINDOW (CONTINUED)

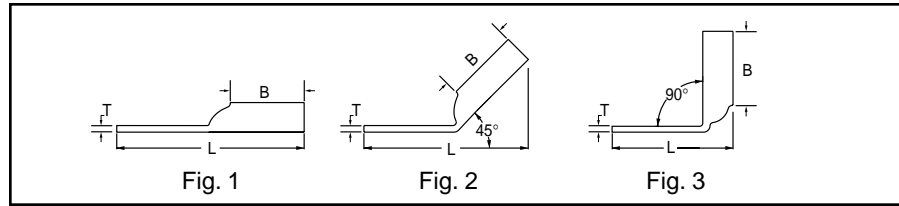

C-58

Catalog Number	Fig #	Conductor		Stud Hole Size	Stud Hole Spacing	Tongue Width	Figure Dimensions			Dieless (# of crimps)	▲ Installation Tooling					Wire Strip Length									
		AWG	MM ²				(B)	(T)	(L)		Mechanical		Hydraulic		Color Code		Die Index								
											MD6, OUR840 MD7-34R	BCT500HS Y500CTHS	Y35, Y39, Y750 Y46, BAT35, BAT750												
YAZ28-2TC38	1	4/0 AWG	-	3/8"	1"	1.02"	1.62"	.14"	3.99"	MY29-3 (2) MY29-11 (2) MRC840 (4) Y644M (1)	W28VT (4) W28RT (4) X28RT (6)	W28VT (4) W28RT (4) X28RT (6)	U28RT (2)	Purple	15	1-11/16"									
YAZ28-2TC38-45	2						1.62"	.14"	3.69"																
YAZ28-2TC38-90	3						1.62"	.14"	2.30"																
YAZ28-2NTC38	1			3/8"	1-3/4"	1.02"	1.62"	.14"	4.74"																
YAZ28-2NTC38-45	2						1.62"	.14"	4.44"																
YAZ28-2NTC38-90	3						1.62"	.14"	3.05"																
YAZ29-2N	1	250 kcmil	-	1/2"	1-3/4"	1.10"	1.62"	.16"	5.18"	MY29-3 (2) MY29-11(2) Y644M (1)	W29VT (4) X29RT (8)	X29RT (8) W29VT (4) W29RT (4)	U29RT (2)	Yellow	16	1-11/16"									
YAZ29-2N-45	2						1.62"	.16"	4.92"																
YAZ29-2N-90	3						1.62"	.16"	3.52"																
YAZ29-2TC38	1			3/8"	1"	1.10"	1.62"	.14"	3.99"																
YAZ29-2TC38-45	2						1.62"	.14"	3.73"																
YAZ29-2TC38-90	3						1.62"	.14"	2.34"																
YAZ30-2N	1	300 kcmil	150	1/2"	1-3/4"	1.20"	2.00"	.16"	5.60"	Y644M (1)	W30VT (4)	W30VT (4) W30RT (4)	U30RT (4) U28ART (4)	White	17 or 298	2-1/16"									
YAZ30-2N-45	2						2.00"	.16"	5.23"																
YAZ30-2N-90	3						2.00"	.16"	3.56"																
YAZ30-2TC38	1			3/8"	1"	1.20"	2.00"	.16"	4.42"																
YAZ30-2TC38-45	2						2.00"	.16"	4.04"																
YAZ30-2TC38-90	3						2.00"	.16"	2.37"																
YAZ31-2N	1	350 kcmil	185	1/2"	1-3/4"	1.29"	2.00"	.18"	5.64"	Y644M (1)	W31VT (4)	W31VT (4) W31RT (4)	U31RT (4) U29ART (4)	Red	18 or 324	2-1/16"									
YAZ31-2N-45	2						2.00"	.18"	5.29"																
YAZ31-2N-90	3						2.00"	.18"	3.60"																
YAZ31-2TC14E2	1			3/8"	1"	1.29"	2.00"	.18"	4.02"																
YAZ31-2TC14E2-45	2						2.00"	.18"	3.66"																
YAZ31-2TC14E2-90	3						2.00"	.18"	1.97"																
YAZ31-2TC38	1	3/8"	1"	1.29"	2.00"	.18"	4.45"																		
YAZ31-2TC38-45	2				2.00"	.18"	4.10"																		
YAZ31-2TC38-90	3				2.00"	.18"	2.41"																		
YAZ32-2N	1	400 kcmil	-	1/2"	1-3/4"	1.40"	2.12"	.19"	5.81"	Y644M (1)	W32VT (4)	W32VT (4) W32RT (4)	U32RT (4) U30ART (4)	Blue	19 or 470	2/16"									
YAZ32-2N-45	2						2.12"	.19"	5.44"																
YAZ32-2N-90	3						2.12"	.19"	3.64"																
YAZ32-2TC38	1			3/8"	1"	1.40"	2.12"	.19"	4.62"																
YAZ32-2TC38-45	2						2.12"	.19"	4.25"																
YAZ32-2TC38-90	3						2.12"	.19"	2.46"																
YAZ33-2N	1	450 kcmil	-	1/2"	1-3/4"	1.48"	2.13"	.21"	5.89"	Y644M (1)	W33VT (4)	W33VT (4) W33RT (4)	U33RT (4)	Gray	326 or 538	2-5/16"									
YAZ33-2N-45	2						2.13"	.21"	5.54"																
YAZ33-2N-90	3						2.13"	.21"	3.70"																
YAZ34-2N	1			500 kcmil	240	1/2"	1-3/4"	1.55"	2.25"								.23"	6.04"	Y644M (1)	W34VT (4)	W34VT (4) W34RT (4)	U34RT (4) U31ART (4)	Brown	20 or 299	2-5/16"
YAZ34-2N-45	2								2.25"								.23"	5.69"							
YAZ34-2N-90	3								2.25"								.23"	3.73"							
YAZ34-2TC14E2	1	3/8"	1"			1.55"	2.25"	.23"	4.42"																
YAZ34-2TC14E2-45	2						2.25"	.23"	4.06"																
YAZ34-2TC14E2-90	3						2.25"	.23"	2.10"																
YAZ34-2TC38	1	3/8"	1"	1.55"	2.25"	.23"	4.85"																		
YAZ34-2TC38-45	2				2.25"	.23"	4.50"																		
YAZ34-2TC38-90	3				2.25"	.23"	2.54"																		
YAZ35-2N	1	550 kcmil	-	1/2"	1-3/4"	1.65"	2.63"	.25"	6.45"	-	-	U35RT (4)	Yellow	21	2-11/16"										
YAZ35-2N-45	2						2.63"	.25"	6.03"																
YAZ35-2N-90	3						2.63"	.25"	3.77"																

▲ See tooling section of this catalog for complete tool and die listings.
 * Use P-UADP-1 adaptor with "U" -dies in Y46 HYPRESS™.
 ** P-RT die sets for use in Y46 HYPRESS™ only, P-UADP-1 adaptor not required.

*** The MM² conductor sizes listed are the recommendations for Class 2 conductor.
 * Available undrilled. Add suffix "U" to catalog number (example: YA25U).

◆ For applications greater than 2000 Volts consult cable manufacturer for voltage stress relief instructions.



TWO HOLE HYLUG™ CODE CONDUCTOR LONG BARREL WITH INSPECTION WINDOW (CONTINUED)

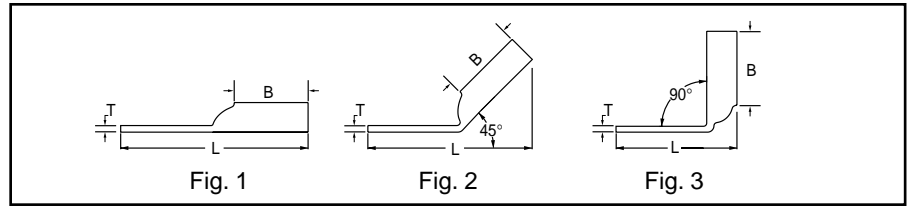

Catalog Number	Fig #	Conductor		Stud Hole Size	Stud Hole Spacing	Tongue Width	Figure Dimensions			▲ Installation Tooling					Wire Strip Length							
		AWG	MM ²				(B)	(T)	(L)	Dieless (# of crimps)	Mechanical MD6, OUR840 MD7-34R	Hydraulic		Color Code		Die Index						
												BCT500HS Y500CTHS	Y35, Y39, Y750 Y46, BAT35, BAT750									
YAZ36-2N	1	600 kcmil	300	1/2"	1-3/4"	1.74"	2.69"	.27"	6.55"	-	-	U36RT (4) U32ART (4)	Green	22 or 472	2/4"							
YAZ36-2N-45	2						2.69"	.27"	6.14"							Y644M (1)	-	-	U39RT (4) P39RT (4) **	Black	24	2-15/16"
YAZ36-2N-90	3						2.69"	.26"	5.55"													
YAZ36-2TC38	1	650 kcmil	-	1/2"	1"	1.74"	2.69"	.26"	5.14"	-	-	-	Orange	23	2-7/8"							
YAZ36-2TC38-45	2						2.69"	.26"	5.14"													
YAZ36-2TC38-90	3						2.69"	.26"	2.81"													
YAZ37-2N	1	700 kcmil	-	1/2"	1-3/4"	1.80"	2.81"	.27"	6.70"	-	-	-	Orange	23	2-7/8"							
YAZ37-2N-45	2						2.81"	.27"	6.26"							Y644M (1)	-	-	U38RT (4)	Pink	400	2-7/8"
YAZ37-2N-90	3						2.81"	.27"	3.84"													
YAZ38-2N	1	750 kcmil	-	1/2"	1-3/4"	1.84"	2.81"	.27"	6.72"	-	-	-	Black	24	2-15/16"							
YAZ38-2N-45	2						2.81"	.27"	6.26"							Y644M (1)	-	-	U39RT (4) P39RT (4) **	Black	24	2-15/16"
YAZ38-2N-90	3						2.81"	.27"	3.84"													
YAZ39-2N	1	800 kcmil	400	1/2"	1-3/4"	1.91"	2.88"	.27"	6.82"	-	-	-	Orange	25	3"							
YAZ39-2N-45	2						2.88"	.27"	6.34"							Y644M (1)	-	-	P40RT (4) **	Orange	25	3"
YAZ39-2N-90	3						2.88"	.27"	3.87"													
YAZ39-2NT38	1	850 kcmil	-	1/2"	1"	1.63"	2.88"	.27"	5.82"	-	-	-	Gold		3"							
YAZ39-2NT38-45	2						2.88"	.27"	5.34"							Y644M (1)	-	-	U39RT (4) P39RT (4) **	Black	24	2-15/16"
YAZ39-2NT38-90	3						2.88"	.27"	2.87"													
YAZ39-2TC38	1	1000 kcmil	500	1/2"	1-3/4"	1.91"	2.88"	.27"	5.82"	-	-	-	White	27	3-1/16"							
YAZ39-2TC38-45	2						2.88"	.27"	5.34"							Y644M (1)	-	-	P44RT (4) **	White	27	3-1/16"
YAZ39-2TC38-90	3						2.88"	.27"	2.87"													
YAZ40-2N	1	1250 kcmil	-	1/2"	1-3/4"	1.98"	2.94"	.30"	6.89"	-	-	-	Yellow	29	3-1/4"							
YAZ40-2N-45	2						2.94"	.30"	6.46"							Y644M (1)	-	-	P45RT (6) **	Yellow	29	3-1/4"
YAZ40-2N-90	3						2.94"	.30"	3.91"													
YAZ41-2N	1	1300 kcmil	-	1/2"	1-3/4"	2.01"	2.94"	.31"	6.91"	-	-	-	Orange	30	2-1/16"							
YAZ41-2N-45	2						2.94"	.31"	6.48"							Y644M (1)	-	-	P46RT (6) **	Green	31	3-5/16"
YAZ41-2N-90	3						2.94"	.31"	3.93"													
YAZ44-2N	1	1500 kcmil	-	1/2"	1-3/4"	2.19"	3.00"	.33"	7.08"	-	-	-	Gray	33	3-1/2"							
YAZ44-2N-45	2						3.00"	.33"	6.66"							Y644M (1)	-	-	P45RT (6) **	Yellow	29	3-1/4"
YAZ44-2N-90	3						3.00"	.33"	4.02"													
YAZ44-2TC38	1	1750 kcmil	-	1/2"	1"	2.19"	3.00"	.33"	6.09"	-	-	-	White	27	3-1/16"							
YAZ44-2TC38-45	2						3.00"	.33"	5.66"							Y644M (1)	-	-	P44RT (4) **	White	27	3-1/16"
YAZ44-2TC38-90	3						3.00"	.33"	3.02"													
YAZ45-2N	1	1500 kcmil	-	1/2"	1-3/4"	2.46"	3.19"	.40"	7.38"	-	-	-	Green	31	3-5/16"							
YAZ45-2N-45	2						3.19"	.40"	6.99"							Y644M (1)	-	-	P46RT (6) **	Green	31	3-5/16"
YAZ45-2N-90	3						3.19"	.40"	4.13"													
YAZ453-2N	1	1750 kcmil	-	1/2"	1-3/4"	2.53"	3.19"	.39"	7.41"	-	-	-	Orange	30	2-1/16"							
YAZ453-2N-45	2						3.19"	.39"	7.03"							Y644M (1)	-	-	P45RT (6) **	Yellow	29	3-1/4"
YAZ453-2N-90	3						3.19"	.39"	4.16"													
YAZ46-2N	1	1750 kcmil	-	1/2"	1-3/4"	2.69"	3.19"	.40"	7.48"	-	-	-	Green	31	3-5/16"							
YAZ46-2N-45	2						3.19"	.40"	7.10"							Y644M (1)	-	-	P46RT (6) **	Green	31	3-5/16"
YAZ46-2N-90	3						3.19"	.40"	4.22"													
YAZ47-2N	1	1750 kcmil	-	1/2"	1-3/4"	2.90"	3.44"	.42"	7.82"	-	-	-	Gray	33	3-1/2"							
YAZ47-2N-45	2						3.44"	.42"	7.40"							Y644M (1)	-	-	-	Gray	33	3-1/2"
YAZ47-2N-90	3						3.44"	.42"	4.30"													

▲ See tooling section of this catalog for complete tool and die listings.
 * Use P-UADP-1 adaptor with "U" -dies in Y46 HYPRESS™.
 ** P-RT die sets for use in Y46 HYPRESS™ only, P-UADP-1 adaptor not required.

*** The MM² conductor sizes listed are the recommendations for Class 2 conductor.
 " Available undrilled. Add suffix "U" to catalog number (example: YA25U).

◆ For applications greater than 2000 Volts consult cable manufacturer for voltage stress relief instructions.



TWO HOLE HYLUG™ CODE CONDUCTOR LONG BARREL WITH INSPECTION WINDOW (CONTINUED)

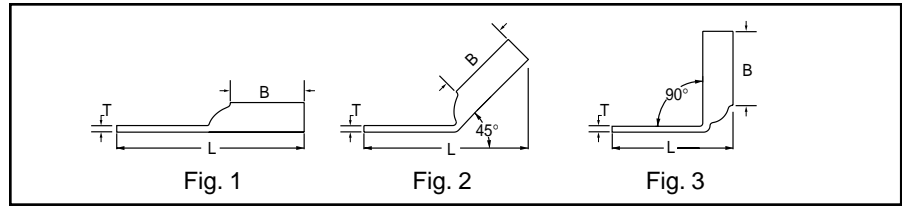

C-60

Catalog Number	Fig #	Conductor		Stud Hole Size	Stud Hole Spacing	Tongue Width	Figure Dimensions			▲ Installation Tooling					Wire Strip Length	
		AWG	MM ²				(B)	(T)	(L)	Dieless (# of crimps)	Mechanical	Hydraulic		Color Code		Die Index
											MD6, OUR840 MD7-34R	BCT500HS Y500CTHS	Y35, Y39, Y750 Y46, BAT35, BAT750			
YAZ48-2N	1	2000 kcmil	-	1/2"	1-3/4"	3.10"	3.44"	.46"	7.89"	-	-	-	Brown	34	3-1/2"	
YAZ48-2N-45	2								7.54"							
YAZ48-2N-90	3								4.40"							

- ▲ See tooling section of this catalog for complete tool and die listings.
- * Use P-UADP-1 adaptor with "U" dies in Y46 HYPRESS™.
- ** P-RT die sets for use in Y46 HYPRESS™ only, P-UADP-1 adaptor not required.
- *** The MM² conductor sizes listed are the recommendations for Class 2 conductor.
- " Available undrilled. Add suffix "U" to catalog number (example: YA25U).
- ◆ For applications greater than 2000 Volts consult cable manufacturer for voltage stress relief instructions.