

# DATA SHEET

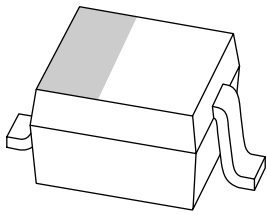

## **PDZ-B series** Voltage regulator diodes

Product data sheet  
Supersedes data of 2002 Feb 18

2004 Mar 22

# Voltage regulator diodes

# PDZ-B series

### FEATURES

- Total power dissipation: max. 400 mW
- Small plastic package suitable for surface mounted design
- Wide variety of voltage ranges: nominal 2.4 to 36 V (E24 range)
- Tolerance approximately  $\pm 2\%$ .

### APPLICATIONS

- General voltage regulation.

### DESCRIPTION

Low-power general purpose voltage regulator diodes in a small plastic SMD SOD323 (SC-76) package.

### PINNING

PIN	DESCRIPTION
1	cathode
2	anode

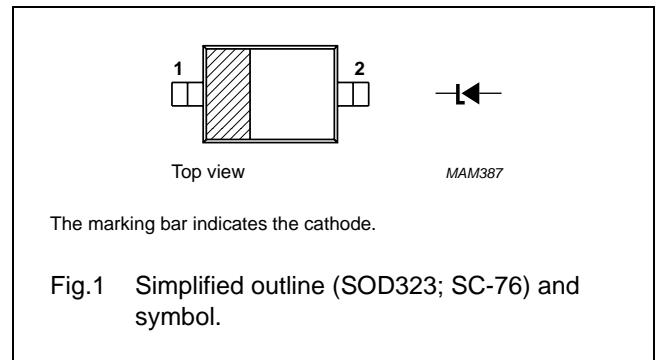

### MARKING

TYPE NUMBER	MARKING CODE	TYPE NUMBER	MARKING CODE	TYPE NUMBER	MARKING CODE	TYPE NUMBER	MARKING CODE
PDZ2.4B	Z0	PDZ5.1B	Z8	PDZ11B	ZG	PDZ24B	ZQ
PDZ2.7B	Z1	PDZ5.6B	Z9	PDZ12B	ZH	PDZ27B	ZR
PDZ3.0B	Z2	PDZ6.2B	ZA	PDZ13B	ZJ	PDZ30B	ZS
PDZ3.3B	Z3	PDZ6.8B	ZB	PDZ15B	ZK	PDZ33B	ZT
PDZ3.6B	Z4	PDZ7.5B	ZC	PDZ16B	ZL	PDZ36B	ZU
PDZ3.9B	Z5	PDZ8.2B	ZD	PDZ18B	ZM		
PDZ4.3B	Z6	PDZ9.1B	ZE	PDZ20B	ZN		
PDZ4.7B	Z7	PDZ10B	ZF	PDZ22B	ZP		

### ORDERING INFORMATION

TYPE NUMBER	PACKAGE		
	NAME	DESCRIPTION	VERSION
PDZ2.4B to PDZ36B	-	plastic surface mounted package; 2 leads	SOD323

## Voltage regulator diodes

## PDZ-B series

**LIMITING VALUES**

In accordance with the Absolute Maximum Rating System (IEC 60134).

SYMBOL	PARAMETER	CONDITIONS	MIN.	MAX.	UNIT
$I_F$	continuous forward current		–	200	mA
$I_{ZSM}$	non-repetitive peak reverse current	$t_p = 100 \mu\text{s}$ ; square wave; $T_{amb} = 25 \text{ }^\circ\text{C}$ prior to surge	see Table 2		
$P_{tot}$	total power dissipation	$T_{amb} = 25 \text{ }^\circ\text{C}$ ; note 1; see Fig.2	–	400	mW
$T_{stg}$	storage temperature		–65	+150	$^\circ\text{C}$
$T_j$	junction temperature		–	150	$^\circ\text{C}$

**Note**

1. Device mounted on a printed-circuit board measuring  $11 \times 25 \times 1.6 \text{ mm}$ .

**THERMAL CHARACTERISTICS**

SYMBOL	PARAMETER	CONDITIONS	VALUE	UNIT
$R_{th(j-s)}$	thermal resistance from junction to soldering point		130	K/W
$R_{th(j-a)}$	thermal resistance from junction to ambient	note 1	340	K/W

**Note**

1. Device mounted on a printed-circuit board measuring  $11 \times 25 \times 1.6 \text{ mm}$ .

## Voltage regulator diodes

## PDZ-B series

## CHARACTERISTICS

Table 1 Total series

 $T_j = 25\text{ }^\circ\text{C}$  unless otherwise specified.

SYMBOL	PARAMETER	CONDITIONS	MAX.	UNIT
$V_F$	forward voltage	$I_F = 10\text{ mA}$ ; see Fig.3	0.9	V
		$I_F = 100\text{ mA}$ ; see Fig.3	1.1	V
$I_R$	reverse current			
	PDZ2.4B	$V_R = 1\text{ V}$	50	$\mu\text{A}$
	PDZ2.7B	$V_R = 1\text{ V}$	20	$\mu\text{A}$
	PDZ3.0B	$V_R = 1\text{ V}$	10	$\mu\text{A}$
	PDZ3.3B	$V_R = 1\text{ V}$	5	$\mu\text{A}$
	PDZ3.6B	$V_R = 1\text{ V}$	5	$\mu\text{A}$
	PDZ3.9B	$V_R = 1\text{ V}$	3	$\mu\text{A}$
	PDZ4.3B	$V_R = 1\text{ V}$	3	$\mu\text{A}$
	PDZ4.7B	$V_R = 1\text{ V}$	2	$\mu\text{A}$
	PDZ5.1B	$V_R = 1.5\text{ V}$	2	$\mu\text{A}$
	PDZ5.6B	$V_R = 2.5\text{ V}$	1	$\mu\text{A}$
	PDZ6.2B	$V_R = 3\text{ V}$	500	nA
	PDZ6.8B	$V_R = 3.5\text{ V}$	500	nA
	PDZ7.5B	$V_R = 4\text{ V}$	500	nA
	PDZ8.2B	$V_R = 5\text{ V}$	500	nA
	PDZ9.1B	$V_R = 6\text{ V}$	500	nA
	PDZ10B	$V_R = 7\text{ V}$	100	nA
	PDZ11B	$V_R = 8\text{ V}$	100	nA
	PDZ12B	$V_R = 9\text{ V}$	100	nA
	PDZ13B	$V_R = 10\text{ V}$	100	nA
	PDZ15B	$V_R = 11\text{ V}$	50	nA
	PDZ16B	$V_R = 12\text{ V}$	50	nA
	PDZ18B	$V_R = 13\text{ V}$	50	nA
PDZ20B	$V_R = 15\text{ V}$	50	nA	
PDZ22B	$V_R = 17\text{ V}$	50	nA	
PDZ24B	$V_R = 19\text{ V}$	50	nA	
PDZ27B	$V_R = 21\text{ V}$	50	nA	
PDZ30B	$V_R = 23\text{ V}$	50	nA	
PDZ33B	$V_R = 25\text{ V}$	50	nA	
PDZ36B	$V_R = 27\text{ V}$	50	nA	

## Voltage regulator diodes

## PDZ-B series

**Table 2** Per type $T_j = 25\text{ °C}$  unless otherwise specified.

TYPE NUMBER	WORKING VOLTAGE $V_Z$ (V) at $I_Z = 5\text{ mA}$		DIFFERENTIAL RESISTANCE $r_{dif}$ ( $\Omega$ )				TEMP. COEFF. $S_Z$ (mV/K) at $I_Z = 5\text{ mA}$ (see Figs 4 and 5)	DIODE CAP. $C_d$ (pF) at $f = 1\text{ MHz}$ ; $V_R = 0$	NON-REPETITIVE PEAK REVERSE CURRENT $I_{ZSM}$ (A) at $t_p = 100\text{ }\mu\text{s}$ ; $T_{amb} = 25\text{ °C}$
	MIN.	MAX.	MAX.	at $I_Z$ (mA)	MAX.	at $I_Z$ (mA)	TYP.	MAX.	MAX.
PDZ2.4B	2.43	2.63	1000	0.5	100	5	-1.6	450	8.0
PDZ2.7B	2.69	2.91	1000	0.5	100	5	-2.0	440	8.0
PDZ3.0B	2.85	3.07	1000	0.5	95	5	-2.1	425	8.0
PDZ3.3B	3.32	3.53	1000	0.5	95	5	-2.4	410	8.0
PDZ3.6B	3.60	3.85	500	1.0	90	5	-2.4	390	8.0
PDZ3.9B	3.89	4.16	500	1.0	90	5	-2.5	370	8.0
PDZ4.3B	4.17	4.48	600	1.0	90	5	-2.5	350	8.0
PDZ4.7B	4.55	4.75	600	1.0	90	5	-1.4	325	8.0
PDZ5.1B	4.96	5.20	250	0.5	60	5	0.3	300	5.5
PDZ5.6B	5.48	5.73	100	0.5	50	5	1.9	275	5.5
PDZ6.2B	6.06	6.33	80	0.5	50	5	2.7	250	5.5
PDZ6.8B	6.65	6.93	60	0.5	40	5	3.4	215	5.5
PDZ7.5B	7.28	7.60	60	0.5	10	5	4.0	170	3.5
PDZ8.2B	8.02	8.36	60	0.5	10	5	4.6	150	3.5
PDZ9.1B	8.85	9.23	60	0.5	10	5	5.5	120	3.5
PDZ10B	9.77	10.21	60	0.5	10	5	6.4	110	3.5
PDZ11B	10.78	11.22	60	0.5	10	5	7.4	108	3.0
PDZ12B	11.74	12.24	80	0.5	10	5	8.4	105	3.0
PDZ13B	12.91	13.49	80	0.5	10	5	9.4	103	2.5
PDZ15B	14.34	14.98	80	0.5	15	5	11.4	99	2.0
PDZ16B	15.85	16.51	80	0.5	20	5	12.4	97	1.5
PDZ18B	17.56	18.35	80	0.5	20	5	14.4	93	1.5
PDZ20B	19.52	20.39	100	0.5	20	5	16.4	88	1.5
PDZ22B	21.54	22.47	100	0.5	25	5	18.4	84	1.3
PDZ24B	23.72	24.78	120	0.5	30	5	20.4	80	1.3
PDZ27B	26.19	27.53	150	0.5	40	5	23.4	73	1.0
PDZ30B	29.19	30.69	200	0.5	40	5	26.6	66	1.0
PDZ33B	32.15	33.79	250	0.5	40	5	29.7	60	0.9
PDZ36B	35.07	36.87	300	0.5	60	5	33.0	59	0.8

Voltage regulator diodes

PDZ-B series

GRAPHICAL DATA

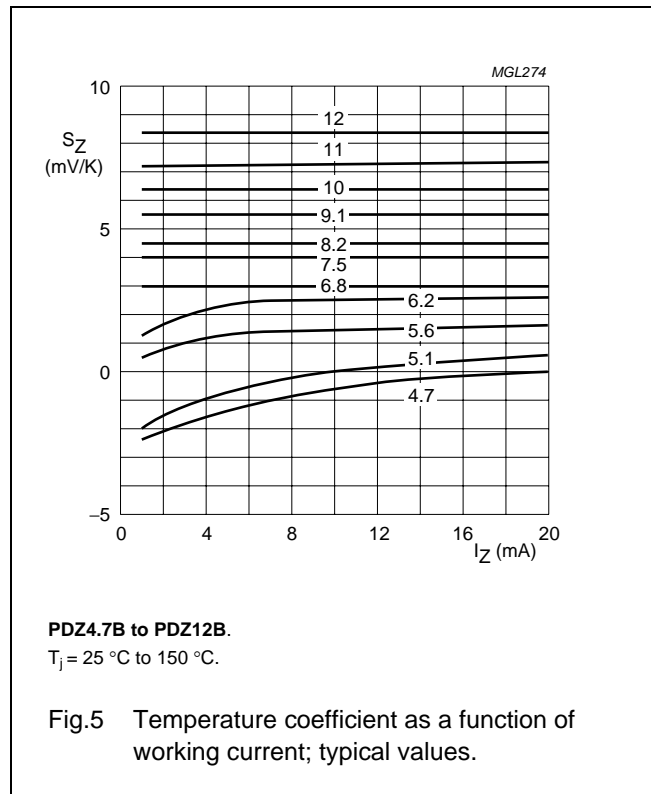
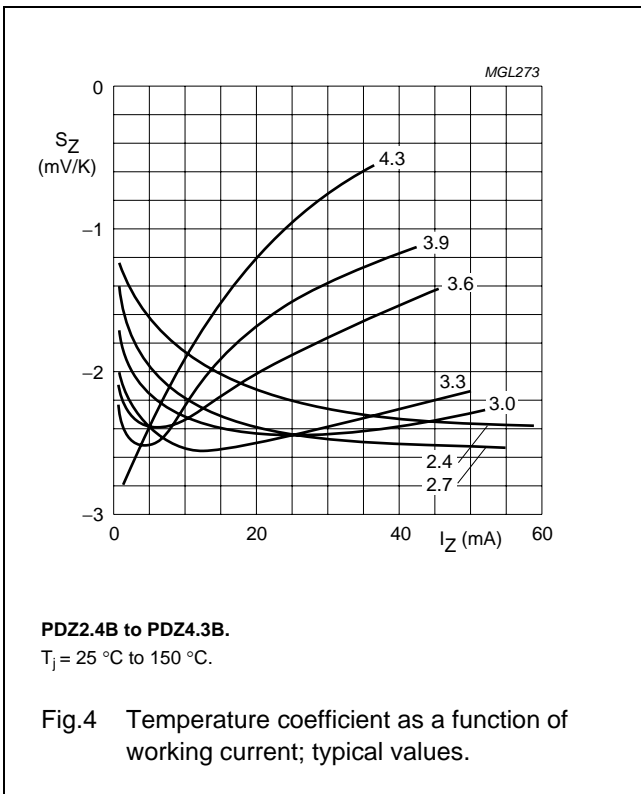
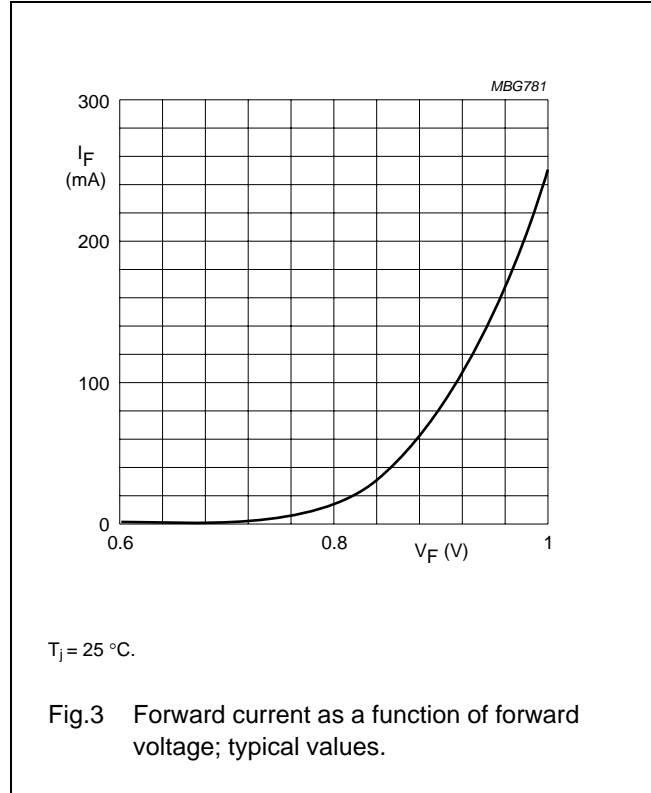
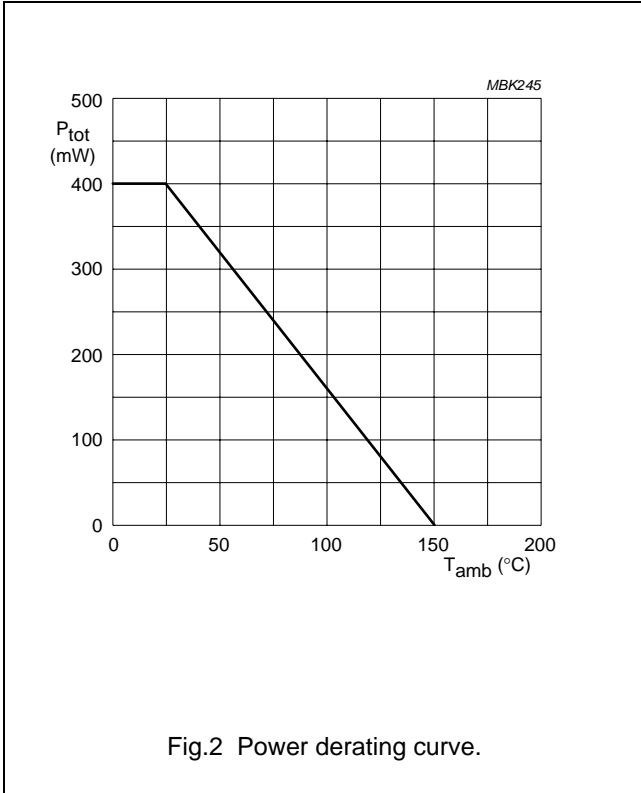

Voltage regulator diodes

PDZ-B series

PACKAGE OUTLINE

Plastic surface-mounted package; 2 leads

SOD323

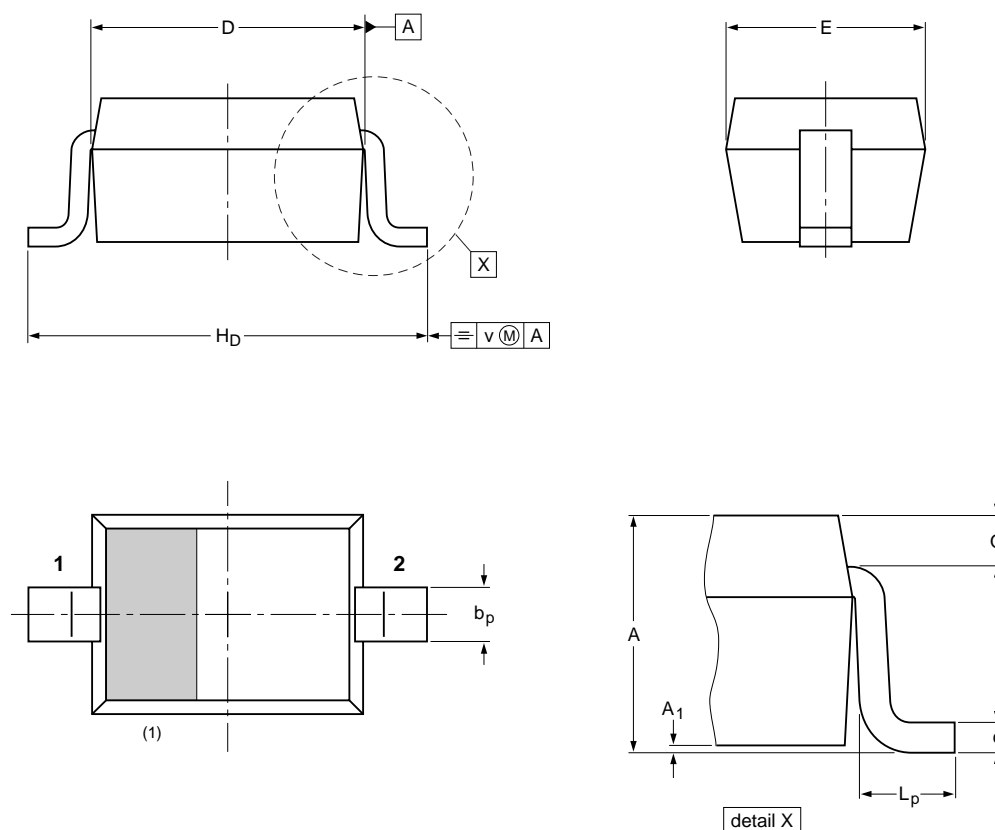

DIMENSIONS (mm are the original dimensions)

UNIT	A	A <sub>1</sub> max	b <sub>p</sub>	c	D	E	H <sub>D</sub>	L <sub>p</sub>	Q	v
mm	1.1 0.8	0.05	0.40 0.25	0.25 0.10	1.8 1.6	1.35 1.15	2.7 2.3	0.45 0.15	0.25 0.15	0.2

Note

1. The marking bar indicates the cathode

OUTLINE VERSION	REFERENCES			EUROPEAN PROJECTION	ISSUE DATE
	IEC	JEDEC	JEITA		
SOD323			SC-76		-03-12-17- 06-03-16

## Voltage regulator diodes

## PDZ-B series

## DATA SHEET STATUS

DOCUMENT STATUS <sup>(1)</sup>	PRODUCT STATUS <sup>(2)</sup>	DEFINITION
Objective data sheet	Development	This document contains data from the objective specification for product development.
Preliminary data sheet	Qualification	This document contains data from the preliminary specification.
Product data sheet	Production	This document contains the product specification.

## Notes

1. Please consult the most recently issued document before initiating or completing a design.
2. The product status of device(s) described in this document may have changed since this document was published and may differ in case of multiple devices. The latest product status information is available on the Internet at URL <http://www.nxp.com>.

## DISCLAIMERS

**General** — Information in this document is believed to be accurate and reliable. However, NXP Semiconductors does not give any representations or warranties, expressed or implied, as to the accuracy or completeness of such information and shall have no liability for the consequences of use of such information.

**Right to make changes** — NXP Semiconductors reserves the right to make changes to information published in this document, including without limitation specifications and product descriptions, at any time and without notice. This document supersedes and replaces all information supplied prior to the publication hereof.

**Suitability for use** — NXP Semiconductors products are not designed, authorized or warranted to be suitable for use in medical, military, aircraft, space or life support equipment, nor in applications where failure or malfunction of an NXP Semiconductors product can reasonably be expected to result in personal injury, death or severe property or environmental damage. NXP Semiconductors accepts no liability for inclusion and/or use of NXP Semiconductors products in such equipment or applications and therefore such inclusion and/or use is at the customer's own risk.

**Applications** — Applications that are described herein for any of these products are for illustrative purposes only. NXP Semiconductors makes no representation or warranty that such applications will be suitable for the specified use without further testing or modification.

**Limiting values** — Stress above one or more limiting values (as defined in the Absolute Maximum Ratings System of IEC 60134) may cause permanent damage to the device. Limiting values are stress ratings only and operation of the device at these or any other conditions

above those given in the Characteristics sections of this document is not implied. Exposure to limiting values for extended periods may affect device reliability.

**Terms and conditions of sale** — NXP Semiconductors products are sold subject to the general terms and conditions of commercial sale, as published at <http://www.nxp.com/profile/terms>, including those pertaining to warranty, intellectual property rights infringement and limitation of liability, unless explicitly otherwise agreed to in writing by NXP Semiconductors. In case of any inconsistency or conflict between information in this document and such terms and conditions, the latter will prevail.

**No offer to sell or license** — Nothing in this document may be interpreted or construed as an offer to sell products that is open for acceptance or the grant, conveyance or implication of any license under any copyrights, patents or other industrial or intellectual property rights.

**Export control** — This document as well as the item(s) described herein may be subject to export control regulations. Export might require a prior authorization from national authorities.

**Quick reference data** — The Quick reference data is an extract of the product data given in the Limiting values and Characteristics sections of this document, and as such is not complete, exhaustive or legally binding.



# ***NXP Semiconductors***

## **Customer notification**

This data sheet was changed to reflect the new company name NXP Semiconductors, including new legal definitions and disclaimers. No changes were made to the technical content, except for package outline drawings which were updated to the latest version.

## **Contact information**

For additional information please visit: <http://www.nxp.com>

For sales offices addresses send e-mail to: [salesaddresses@nxp.com](mailto:salesaddresses@nxp.com)

© NXP B.V. 2009

All rights are reserved. Reproduction in whole or in part is prohibited without the prior written consent of the copyright owner.

The information presented in this document does not form part of any quotation or contract, is believed to be accurate and reliable and may be changed without notice. No liability will be accepted by the publisher for any consequence of its use. Publication thereof does not convey nor imply any license under patent- or other industrial or intellectual property rights.

Printed in The Netherlands

R76/05/pp9

Date of release: 2004 Mar 22

Document order number: 9397 750 12615

