

CDSV6-4448D-G

RoHS Device

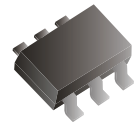

Features

- Fast switching speed.
- Ultra-small surface mount package.
- For general purpose switching applications.
- High conductance power dissipation.

Mechanical data

- Case: SOT-363, molded plastic.
- Terminals: Solder plated, solderable per MIL-STD-750, method 2026.
- Mounting position: Any.
- Weight: 0.0091 gram (approx.)

Marking: KA3

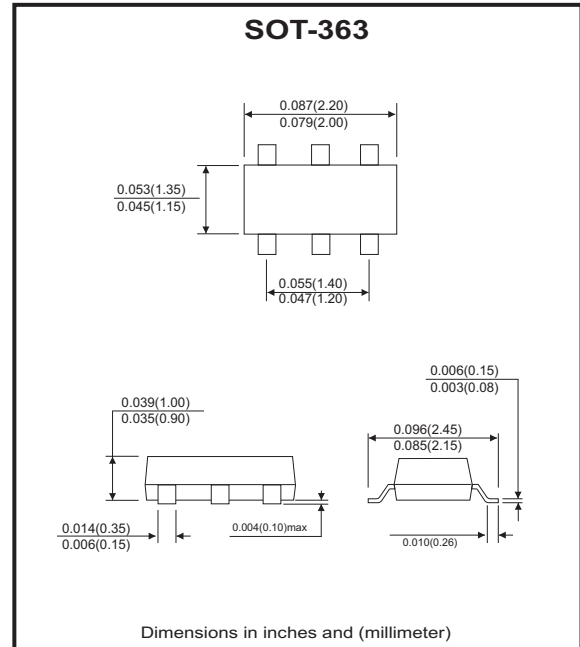
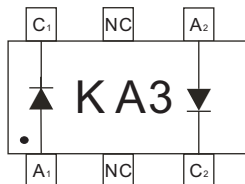

Maximum Ratings (at Ta=25°C unless otherwise noted)

Parameter	Symbol	Value	Unit
Non-repetitive peak reverse voltage	V_{RM}	100	V
Peak repetitive reverse voltage	V_{RRM}	75	V
Working peak reverse voltage	V_{RWM}		
DC Blocking voltage	V_R		
RMS Reverse voltage	$V_{R(RMS)}$	53	V
Forward continuous current	I_{FM}	500	mA
Average rectified output current	I_o	250	mA
Non-repetitive peak forward surge current @ $t < 1\mu s$ @ $t < 1s$	I_{FSM}	4 2	A
Power dissipation	P_d	200	mW
Thermal resistance junction to ambient air	$R_{\theta JA}$	625	°C/W
Operating and storage temperature range	T_j, T_{STG}	-65 to +150	°C

Electrical Characteristics (at Ta=25°C unless otherwise noted)

Parameter	Conditions	Symbol	Min	Typ	Max	Unit
Reverse breakdown voltage	$I_R = 10\mu A$	V_{BR}	75			V
Forward voltage	$I_F = 50mA$ $I_F = 10mA$ $I_F = 50mA$ $I_F = 150mA$	V_F	0.62		0.720 0.855 1.0 1.25	V
Reverse current	$V_R = 75V$ $V_R = 75V, T_J = 150^\circ C$ $V_R = 25V, T_J = 150^\circ C$ $V_R = 20V$	I_R			2.5 50 30 25	μA μA μA nA
Diode junction Capacitance	$V_R = 0, f = 1.0MHz$	C_J			4.0	pF
Reverse recovery time	$I_F = I_R = 10mA$ $I_{rr} = 0.1 \times I_R, R_L = 100\Omega$	T_{rr}			4.0	nS

RATING AND CHARACTERISTIC CURVES (CDSV6-4448D-G)

Fig.1 - Forward characteristics

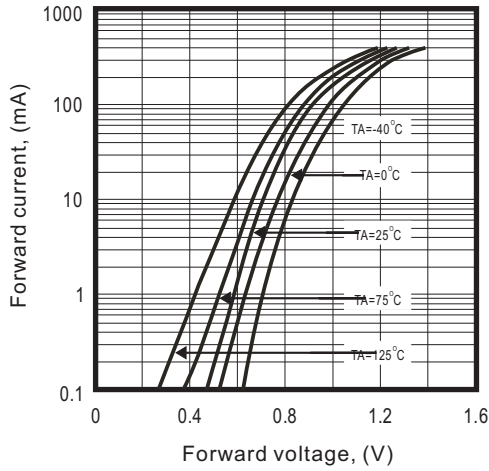

Fig.2 - Reverse characteristics

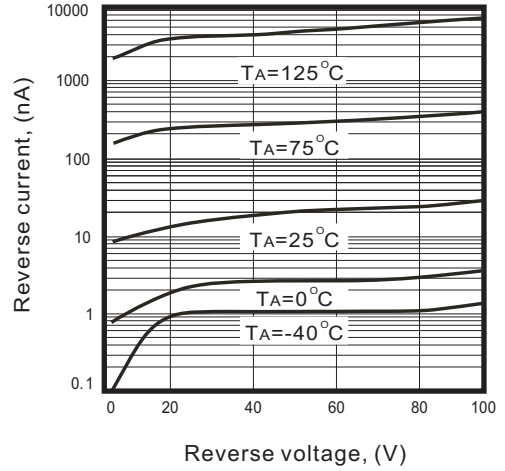

Fig.3 - Capacitance between terminals characteristics

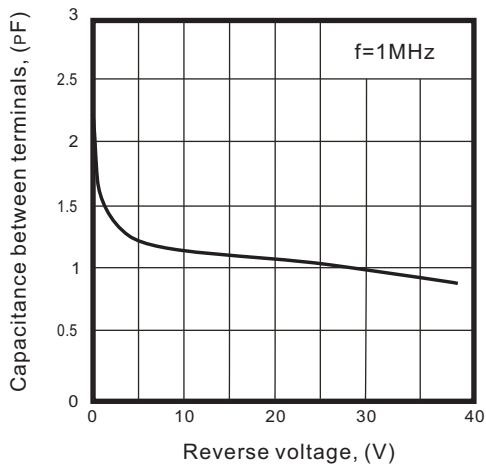

Fig.4 - Power derating curve

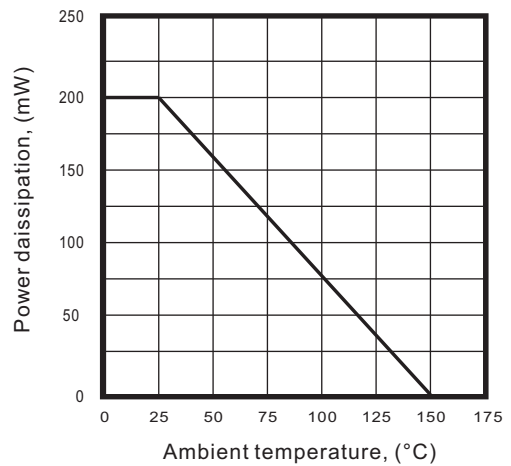
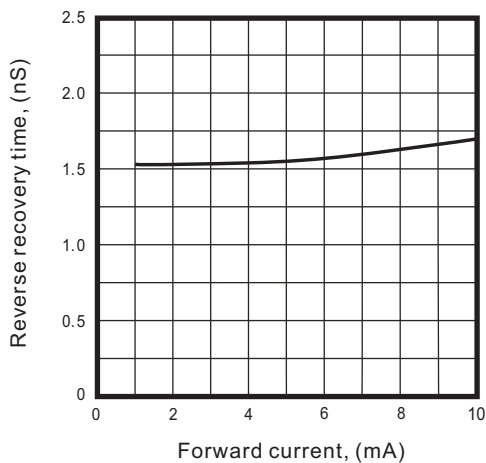
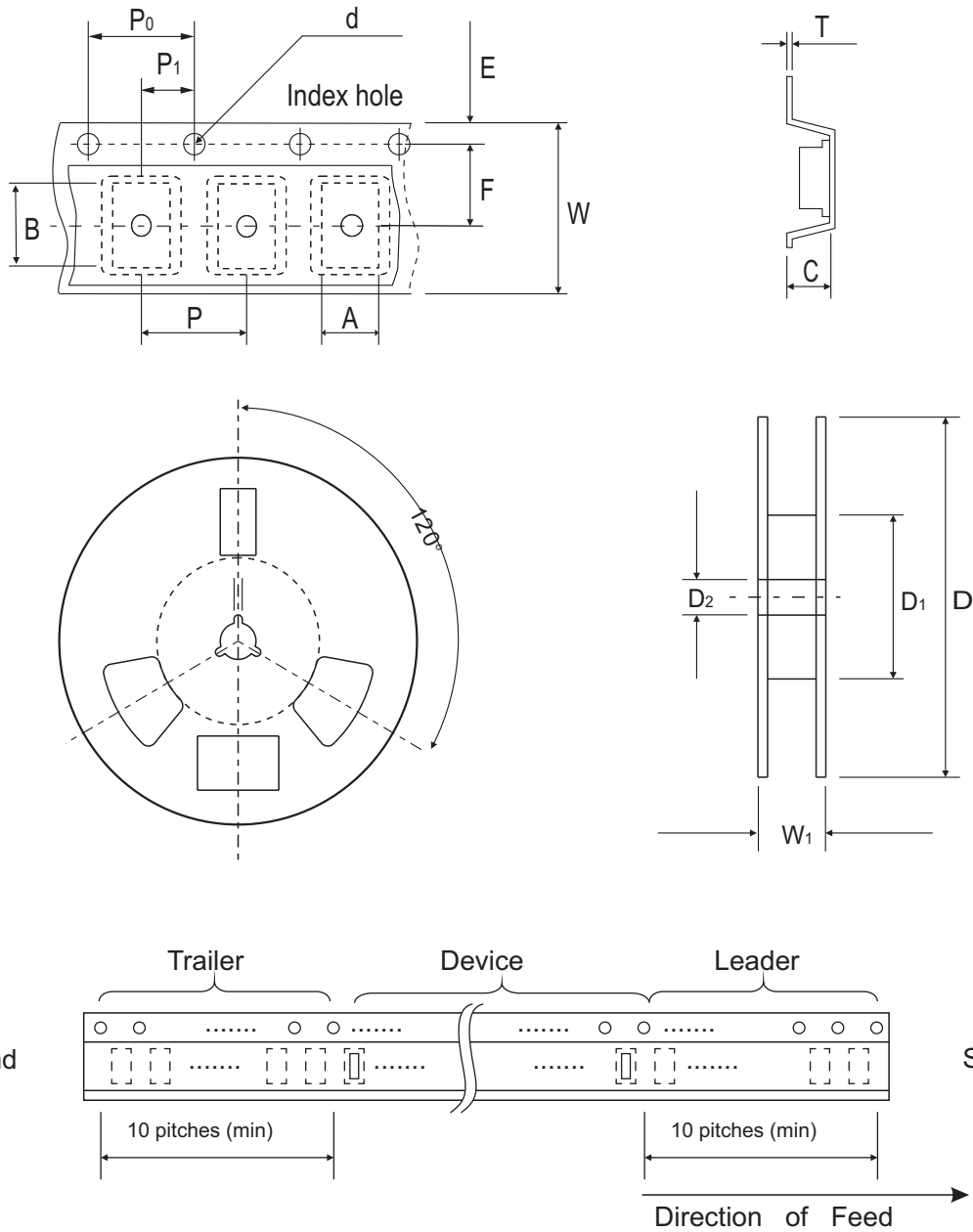

Fig.5 - Reverse recovery time vs. forward current



Reel Taping Specification



SOT-363	SYMBOL	A	B	C	d	D	D1	D2
	(mm)	2.20 ± 0.10	2.40 ± 0.10	1.35 ± 0.10	1.55 ± 0.10	178 ± 1	50.0 MIN.	13.0 ± 0.20
	(inch)	0.087 ± 0.004	0.094 ± 0.004	0.053 ± 0.004	0.061 ± 0.004	7.008 ± 0.040	1.969 MIN.	0.512 ± 0.008

SOT-363	SYMBOL	E	F	P	P0	P1	W	W1
	(mm)	1.75 ± 0.10	3.50 ± 0.05	4.00 ± 0.10	4.00 ± 0.10	2.00 ± 0.05	8.00 ± 0.30	14.4 MAX.
	(inch)	0.069 ± 0.004	0.138 ± 0.002	0.157 ± 0.004	0.157 ± 0.004	0.079 ± 0.002	0.315 ± 0.012	0.567 MAX.

Marking Code

Part Number	Marking Code
CDSV6-4448D	KA3

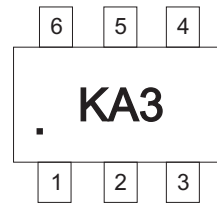

Suggested PAD Layout

SIZE	SOT-363	
	(mm)	(inch)
A	0.80	0.031
B	0.35	0.014
C	1.30	0.051
D	1.94	0.076
E	2.74	0.108

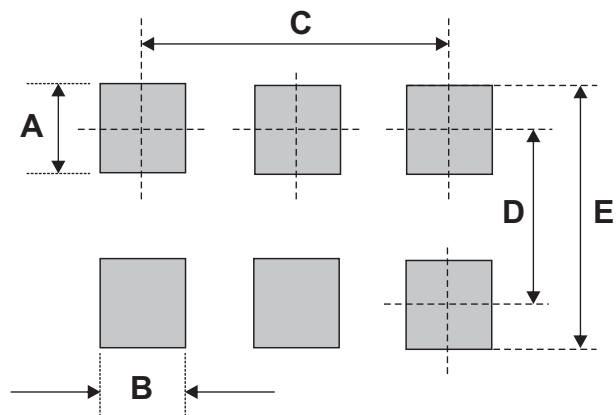

Standard Packaging

Case Type	REEL PACK	
	REEL (pcs)	Reel Size (inch)
SOD-363	3,000	7