



8D Series

D38999 Aluminum Series

Connector part numbers

Basic Series	8D	0	-	11	W	35	P	N	-	-	L
Shell style:											
<ul style="list-style-type: none"> 0: Square flange receptacle 1: In line receptacle 7: Jam nut receptacle 5: Plug with RFI shielding 											
<i>Also available:</i>											
<ul style="list-style-type: none"> . Square flange receptacle with clinch nuts (see page 80) . Jam nut receptacle with double flange (see page 83) 											
Type:											
<ul style="list-style-type: none"> None: Connectors with standard crimp contacts. L: Receptacle with long PC tail (male and female size #22D, #20). C: Receptacle with short PC tail (male and female #22D, #20, #16). S: Receptacle with specific PC tail (male et female #22D) W: Receptacle with male contacts #22D for wire wrap (3 wraps) T: Receptacle with male contacts #20 for wire wrap (2 wraps) P: Receptacle with solder cup - only available for Reinforced sealing Series (see page 75) - male and female size #22D; male #16 & #12; female #16 & #12 and male female #20 please consult us 											
Shell size: 09, 11, 13, 15, 17, 19, 21, 23, 25											
Plating:											
<ul style="list-style-type: none"> W: Olive drab cadmium F: Nickel ZC: Green zinc cobalt Z: Black zinc nickel 											
Contact layout: See pages 13 to 16											
Contact type:											
<ul style="list-style-type: none"> P: Pin A: Connector supplied less pin contact or with specific contacts (connector marking: A + orientation) S: Socket B: Connector supplied less socket contact or with specific contacts (connector marking: B + orientation) 											
Orientation: N, A, B, C, D, E (see page 64)											
Specification:											
<ul style="list-style-type: none"> 046: Tinned straight PC tail 251: Connector provided with power contacts (layouts with contact #8) 022: Fuel tank 											
Special custom:											
<ul style="list-style-type: none"> None: Standard plastic cap M: Antistatic plastic cap L: For P or S contact type only, connectors delivered without contacts, connectors marking P or S plus orientation 											



8D Series

D38999 Aluminum Series

MIL-DTL-38999 part numbers*

Basic Series	D38999/	20	W	B	35	P	N	L
Shell style:								
20: Square flange receptacle								
24: Jam nut receptacle								
26: Plug with RFI shielding.								
Plating:								
Z: Black zinc nickel								
W: Olive drab cadmium								
F: Nickel								
Shell size: A, B, C, D, E, F, G, H, J								
Contact layout: See page 17 for layout according to MIL-DTL-38999								
Contact type:								
P: Pin								
A: Connector supplied less pin contact or with specific contacts (connector marking: A + orientation)								
S: Socket								
B: Connector supplied less socket contact or with specific contacts (connector marking: B + orientation)								
Orientation: N, A, B, C, D, E (see page 64)								
L: For P or S contact type only, connector delivered without contacts, connector marking P or S (without L)								

* Note: To place an order of MIL connectors delivered without MIL removable crimp contacts and keep P or S plus orientation marking, it must be specify clearly on the order (by adding a suffix L at the end of the P/N or specified in comment).

EN3645 part numbers

Basic Series	EN3645	W	6	G	N	35	B	N
Plating:								
W: Olive drab cadmium								
F: Nickel								
Shell style:								
0: Square flange receptacle								
6: Plug								
7: Jam nut receptacle								
Shell size:								
09=A, 11=B, 13=C, 15=D, 17=E, 19=F, 21=G, 23=H, 25=J								
Grounding:								
N: Standard insert not grounded								
Contact layout:								
See page 17 for layout according to EN3645								
Contact type:								
A: Connector supplied less pin contact								
B: Connector supplied less socket contact								
F: Socket								
M: Pin								
Orientation:								
N, A, B, C, D, E (see page 64)								

8D Series

D38999 Aluminum Series



Dimensions

Receptacle type 0

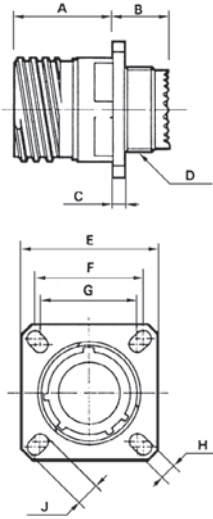

Shell size	A Max	B Max	C Max	D Thread	E ± 0.3	F	G	H ± 0.2	J ± 0.2
09 (A)	20.9	10.72	2.5	M12 x 1-6g	23.8	18.26	15.09	3.25	5.49
11 (B)				M15 x 1-6g	26.2	20.62	18.26		4.93
13 (C)				M18 x 1-6g	28.6	23.01	20.62		4.93
15 (D)				M22 x 1-6g	31	24.61	23.01		
17 (E)				M25 x 1-6g	33.3	26.97	24.61		
19 (F)	20.1	11.54	3.2	M28 x 1-6g	36.5	29.36	26.97	3.91	6.15
21 (G)				M31 x 1-6g	39.7	31.75	29.36		
23 (H)				M34 x 1-6g	42.9	34.93	31.75		
25 (J)				M37 x 1-6g	46	38.1	34.93		

Receptacle type 7

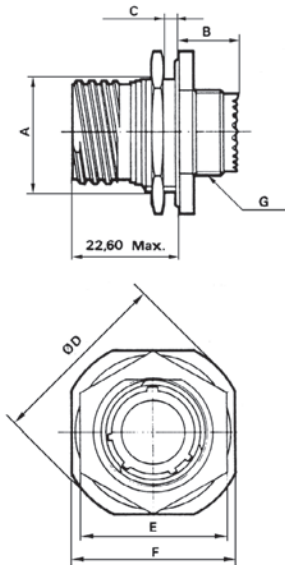

Shell size	A ± 0.15	B Max	C Max	D Max	E Max	F ± 0.4	G Thread
09 (A)	16.53	9.9	3.2	30.5	23	27	M12 x 1-6g
11 (B)	19.07			35.2	26	31.8	M15 x 1-6g
13 (C)	23.82			38.4	31	34.9	M18 x 1-6g
15 (D)	26.97			41.6	34	38.1	M22 x 1-6g
17 (E)	30.15			44.8	37	41.3	M25 x 1-6g
19 (F)	33.32			49.5	41	46	M28 x 1-6g
21 (G)	36.50			52.7	46	49.2	M31 x 1-6g
23 (H)	39.67			55.9	47	52.4	M34 x 1-6g
25 (J)	42.85			59	51.23	55.6	M37 x 1-6g

Recommended coupling torque on panel for jam nut receptacle (type 7)

Shell	09 (A)	11 (B)	13 (C)	15 (D)	17 (E)	19 (F)	21 (G)	23 (H)	25 (J)
Coupling torque (± 0.5 N.m)	4	5	7	8	9	10	12	13	14

Note: All dimensions are in millimeters (mm)

8D Series

D38999 Aluminum Series



In line receptacle type 1

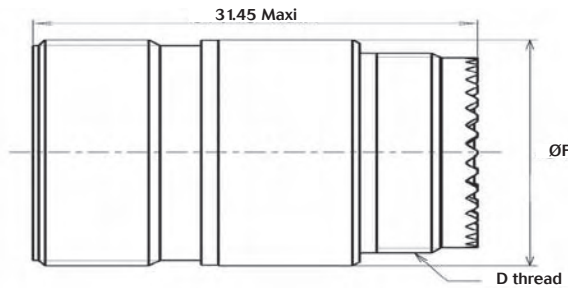

Shell size	D thread	Ø F
09 (A)	M12 x 1 6g	15.90
11 (B)	M15 x 1 6g	19.05
13 (C)	M18 x 1 6g	22.25
15 (D)	M22 x 1 6g	25.40
17 (E)	M25 x 1 6g	30.15
19 (F)	M28 x 1 6g	31.75
21 (G)	M31 x 1 6g	34.75
23 (H)	M34 x 1 6g	37.10
25 (J)	M37 x 1 6g	41.30

Plug type 5

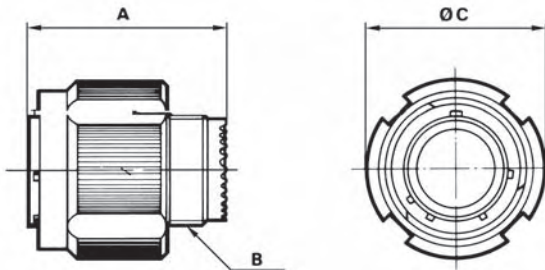

Shell size	A Max	B thread	C Max.
09 (A)	3 .0	M12 x g	21 80
11 (B)	3 .0	M15 x g	25 0
13 (C)	31.00	M18 x 1 6g	29 40
15 (D)	31.00	M22 x 1 6g	32 50
17 (E)	31.00	M25 x 1 6g	35 70
19 (F)	31.00	M28 x 1 6g	38.50
21 (G)	31.00	M31 x 1 6g	41.70
23 (H)	31.00	M34 x 1 6g	44.90
25 (J)	31.00	M37 x 1 6g	48.00

Mated connectors dimensions

Type 0 with plug

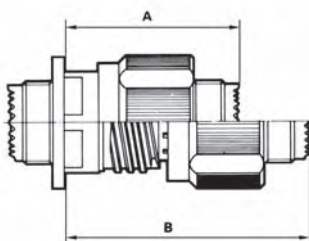

Type 7 with plug

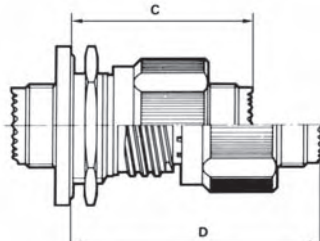

Shell size	A Max.	B Max.	C Max.	D Max.
09 (A)	37.00	52.30	38.30	53.60
11 (B)	37.00	52.30	38.30	53.60
13 (C)	37.00	52.30	38.50	53.80
15 (D)	37.00	52.30	38.50	53.80
17 (E)	37.00	52.30	38.50	53.80
19 (F)	37.00	52.30	38.50	53.80
21 (G)	36.00	51.30	38.50	53.80
23 (H)	36.00	51.30	38.50	53.80
25 (J)	36.00	51.30	38.50	53.80

Note: All dimensions are in millimeters (mm)

8D Series

D38999 Aluminum Series



Receptacle with straight PC tail contacts



		Shell size			09 (A)	11 (B)	13 (C)	15 (C)	17 (E)	19 (F)	21 (G)	23 (H)	25 (J)
		Contact size	Contact type	PC tail type									
A		#22D	M & F	L & C	0.70								
		#22D	M & F	S	0.50								
		#20	M & F	C	0.70								
		#16	M & F	C	1.15								
L1	Min	#22D	M	L & C	10.52							10.34	
	Max	#22D	M	L & C	11.46							11.28	
	Min	#22D	F	L & C	10.19							10.01	
	Max	#22D	F	L & C	11.46							11.28	
	Min	#22D	M	S	10.19							10.01	
	Max	#22D	M	S	11.46							11.28	
	Min	#22D	F	S	10.69							10.51	
	Max	#22D	F	S	11.63							11.45	
	Min	#20	M	C	10.36							10.18	
	Max	#20	M	C	11.63							11.45	
	Min	#20	F	C	10.69							10.51	
	Max	#20	F	C	11.63							11.45	
	Min	#16	M	C	10.69							10.51	
	Max	#16	M	C	11.63							11.45	
	Min	#16	F	C	10.69							10.51	
	Max	#16	F	C	11.63							11.45	
L2		#22D	M & F	L	8.50								
		#22D	M & F	C	4.00								
		#22D	M & F	S	5.10								
		#20	M & F	C	5.10								
		#16	M & F	C	5.10								
L3	Min	#22D	M	L & C	9.48						9.59		
	Max	#22D	M	L & C	10.58						10.69		
	Min	#22D	F	L & C	9.15						9.26		
	Max	#22D	F	L & C	10.58						10.69		
	Min	#22D	M	S	9.65						9.76		
	Max	#22D	M	S	10.75						10.86		
	Min	#22D	F	S	9.15						9.26		
	Max	#22D	F	S	10.75						10.86		
	Min	#20	M	C	9.65						9.76		
	Max	#20	M	C	10.75						10.86		
	Min	#20	F	C	9.65						9.76		
	Max	#20	F	C	10.75						10.86		
	Min	#16	M	C	9.65						9.76		
	Max	#16	M	C	10.75						10.86		
	Min	#16	F	C	9.65						9.76		
	Max	#16	F	C	10.75						10.86		

M: Male contact F: Female contact L: Long PC tail C: Short PC tail S: Specific PC tail *Dimensions in millimeters*



8D Series

D38999 Aluminum Series

Souriau backshells part numbers

Basic Series								8D	102	B	02
Shell style:											
09	11	13	15	17	19	21	23	25			
101	102	103	104	105	106	107	108	109			
Plating:											
B: Olive drab cadmium											
F: Nickel											
Backshell type:											
01: Back nut (please consult us)											
02: Straight cable clamp											
03: 90° cable clamp											
13: Backshell for heat shrink boots											

Cross reference table

Backshell type	AS85049 Standard	Souriau Part Numbers
Back nut	M85049/14-**-x	8D101x01
Straight cable clamp	M85049/38-**-x	8D101x02
90° cable clamp	M85049/39-**-x	8D101x03
Backshell for heat shrink boots	M85049/69-**-x	8D101x13
Backshell for screen termination and cable clamp	M85049/19-**-x	N/A

x: Plating **: Shell size: see pages 13 to 16

8D Series

D38999 Aluminum Series



Backshells - Cable clamp

Straight cable clamp (Type 38)

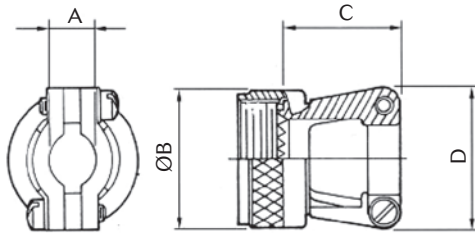

90° cable clamp (Type 39)

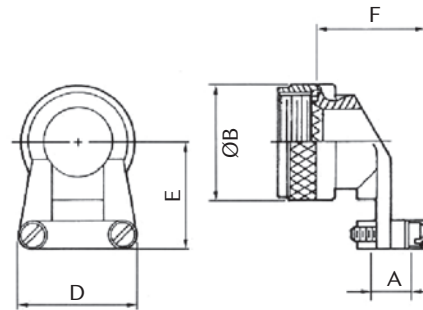

Shell size	A		ØB Max	C Max	D Max	E	F
	Min	Max					
09	2.50	5.90	21.80	23.10	21.60	25.40	25.70
11	3.90	5.90	25.00	23.10	22.90	27.90	25.70
13	4.80	8.30	29.40	25.70	27.90	27.90	30.70
15	6.60	11.60	32.50	26.90	29.20	31.80	32.00
17	7.20	15.60	35.70	29.50	33.00	33.00	35.80
19	8.30	16.10	38.50	35.80	38.10	34.30	38.40
21	8.70	17.70	41.70	38.40	40.60	40.60	42.20
23	9.70	20.90	44.90	42.20	43.20	44.50	44.70
25	10.60	21.70	48.00	44.70	45.70	47.00	48.50

Basic Series	M85049	38	-	11	W
Backshell type:					
38: Straight cable clamp					
39: 90° cable clamp					
Nut type:					
-: Without self-locking					
S: With self-locking					
Shell size:					
09, 11, 13, 15, 17, 19, 21, 23, 25					
Plating:					
Type 38 & 39:					
A: Black anodized (500 hours salt spray)					
W: Olive drab cadmium over nickel (500 hours salt spray)					
Type 38S & 39S:					
W: Olive drab cadmium over nickel (500 hours salt spray)					
N: Nickel (48 hours salt spray)					

Note: All dimensions are in millimeters (mm)

8D Series

D38999 Aluminum Series



Backshell for screen termination and cable clamp

Backshell for screen termination and cable clamp (Type 19)

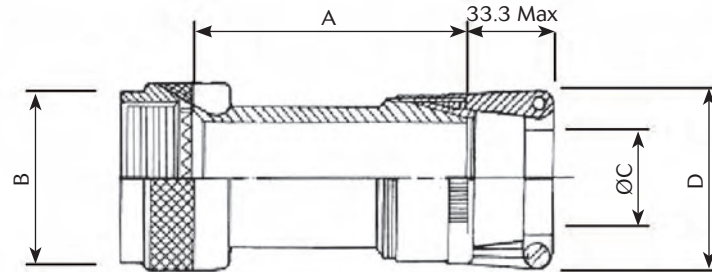

Shell size	A Max	B Max	Clamp indicator base on shell size
09	38.10	19.10	01 - 02
11		21.60	01 - 02 - 03
13		25.40	02 - 03 - 04
15		27.90	02 - 03 - 04 - 05
17		31.80	02 - 03 - 04 - 05 - 06
19		35.60	03 - 04 - 05 - 06 - 07
21		38.10	03 - 04 - 05 - 06 - 07 - 08
23		41.90	03 - 04 - 05 - 06 - 07 - 08
25		44.50	04 - 05 - 06 - 07 - 08 - 10

Clamp size indicator	C		D
	Min	Max	
01	1.60	3.20	20.30
02	3.20	6.35	25.40
03	6.35	9.50	27.90
04	7.90	12.70	30.50
05	11.10	15.90	31.80
06	14.30	19.00	35.60
07	17.45	22.20	38.10
08	20.60	24.40	41.90
09	23.80	28.60	44.50
10	27.00	31.75	48.30

Basic Series M85049 19 11 W 03

Shell style:
19: Backshell for screen termination and cable clamp

Shell size:
09, 11, 13, 15, 17, 19, 21, 23, 25

Plating:
W: Olive drab cadmium
N: Nickel

Clamp size indicator:
See tables above

8D Series

D38999 Aluminum Series



Backshells for heat shrink boots

Backshell for heat shrink boots (Type 69)

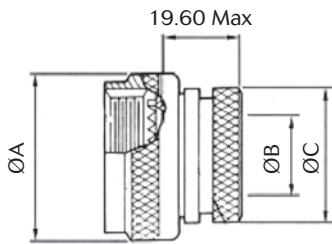

Shell size	ØA Max	ØB Max	ØC Max
09	19.10	6.35	13.55
11	21.60	9.50	15.40
13	25.40	12.70	19.70
15	29.20	15.90	21.30
17	31.80	19.00	24.50
19	35.60	20.60	26.50
21	39.40	23.80	30.90
23	41.90	27.00	34.40
25	47.00	30.20	36.65

Straight backshell for EMI/RFI heat shrink boots (Type 88)

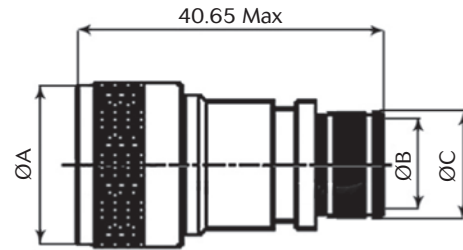

Shell size	ØA Max	ØB ^{±0.10} Entry size		ØC	
		02	03	02	03
09	21.79	-	6.35	-	10.03
11	24.99	-	7.92	-	11.61
13	29.39	7.92	11.13	11.61	14.81
15	32.49	11.13	14.27	14.81	17.96
17	35.71	12.70	15.88	16.38	19.56
19	38.51	15.88	19.05	19.56	22.73
21	41.71	15.88	20.62	19.56	24.30
23	44.91	17.47	23.83	21.06	27.51
25	47.98	19.05	25.40	22.73	29.08

Basic Series

M85049

69

11

A

D

Backshell type:

69: Backshell for heat shrink boots

88: Straight backshell for heat shrink boots

Shell size:

09, 11, 13, 15, 17, 19, 21, 23, 25

Plating:

Type 69:

A: Black anodised (500 hours salt spray)

Type 88:

W: Olive drab cadmium

N: Nickel

Option (Type 69 only):

Empty: Without drain hole

D: With drain hole

Entry size (Type 88 only):

02: See table above

03: See table above

8D Series

D38999 Aluminum Series



Dummy receptacle

Dimensions

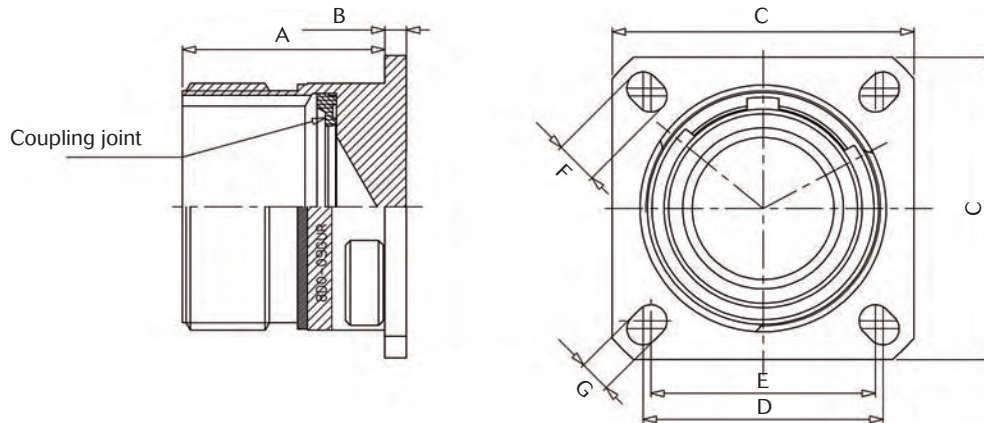

Shell size	Souriau Part number *	A Max	B Max	C ± 0.30	D	E	F ± 0.20	G ± 0.20
09	8D0-09GUR 8D0-09FUR	20.90	2.50	23.80	18.26	15.09	4.49	3.25
11	8D0-11GUR 8D0-11FUR	20.90	2.50	26.20	20.62	18.26	4.93	3.25
13	8D0-13GUR 8D0-13FUR	20.90	2.50	28.60	23.01	20.62	4.93	3.25
15	8D0-15GUR 8D0-15FUR	20.90	2.50	31.00	24.61	23.01	4.93	3.25
17	8D0-17GUR 8D0-17FUR	20.90	2.50	33.30	26.97	24.61	4.93	3.25
19	8D0-19GUR 8D0-19FUR	20.90	2.50	36.50	26.97	24.61	4.93	3.25
21	8D0-21GUR 8D0-21FUR	20.10	3.20	39.70	31.75	29.36	4.93	3.25
23	8D0-23GUR 8D0-23FUR	20.10	3.20	42.90	34.93	31.75	6.15	3.91
25	8D0-25GUR 8D0-25FUR	20.10	3.20	46.00	38.10	34.93	6.15	3.91

* G: Olive green cadmium
F: Nickel

8D Series

D38999 Aluminum Series



Caps

Caps for receptacle (D38999/33 - S2453)

With rope and eyelet

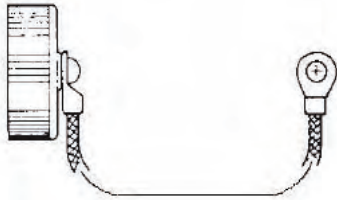

With rope and ring

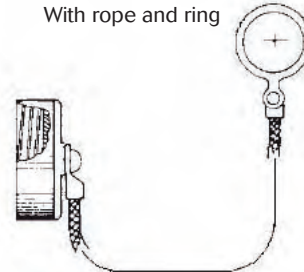

Shell size	Part numbers	
	Plating **	Olive green plating
9	S2453-09W-**	D38999/33 W 09 R
11	S2453-11W-**	D38999/33 W 11 R
13	S2453-13W-**	D38999/33 W 13 R
15	S2453-15W-**	D38999/33 W 15 R
17	S2453-17W-**	D38999/33 W 17 R
19	S2453-19W-**	D38999/33 W 19 R
21	S2453-21W-**	D38999/33 W 21 R
23	S2453-23W-**	D38999/33 W 23 R
25	S2453-25W-**	D38999/33 W 25 R

Shell size	Part numbers	
	Plating **	Olive green plating
9	S2453-09W**-1	D38999/33 W 09 N
11	S2453-11W**-1	D38999/33 W 11 N
13	S2453-13W**-1	D38999/33 W 13 N
15	S2453-15W**-1	D38999/33 W 15 N
17	S2453-17W**-1	D38999/33 W 17 N
19	S2453-19W**-1	D38999/33 W 19 N
21	S2453-21W**-1	D38999/33 W 21 N
23	S2453-23W**-1	D38999/33 W 23 N
25	S2453-25W**-1	D38999/33 W 25 N

Caps for plug (D38999/32 - S2454)

With rope and eyelet

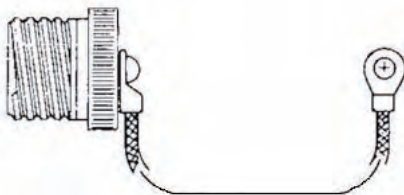

With rope and ring

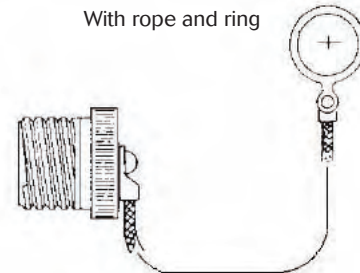

Shell size	Part numbers	
	Plating **	Olive green plating
9	S2454-09F-** S	D38999/32 W 09 R
11	S2454-11F-** S	D38999/32 W 11 R
13	S2454-13F-** S	D38999/32 W 13 R
15	S2454-15F-** S	D38999/32 W 15 R
17	S2454-17F-** S	D38999/32 W 17 R
19	S2454-19F-** S	D38999/32 W 19 R
21	S2454-21F-** S	D38999/32 W 21 R
23	S2454-23F-** S	D38999/32 W 23 R
25	S2454-25F-** S	D38999/32 W 25 R

Shell size	Part numbers	
	Plating **	Olive green plating
9	S2454-09W**-S	D38999/32 W 09 N
11	S2454-11W**-S	D38999/32 W 11 N
13	S2454-13W**-S	D38999/32 W 13 N
15	S2454-15W**-S	D38999/32 W 15 N
17	S2454-17W**-S	D38999/32 W 17 N
19	S2454-19W**-S	D38999/32 W 19 N
21	S2454-21W**-S	D38999/32 W 21 N
23	S2454-23W**-S	D38999/32 W 23 N
25	S2454-25W**-S	D38999/32 W 25 N

** Plating - 34 : Olive green cadmium. Plating - 12 : Nickel.
 Note: Method of attachment to cover and ring is optional. Please consult us.

8D Series

D38999 Aluminum Series



Connectors weight

	With contacts						Without contact					
	Plug (type 5)		Receptacle (type 0)		Receptacle (type 7)		Plug (type 5)		Receptacle (type 0)		Receptacle (type 7)	
	Male	Female	Male	Female	Male	Female	Male	Female	Male	Female	Male	Female
09 – 35	11.47	13.05	9.15	10.73	13.91	15.49	11.05	11.55	8.73	9.23	13.49	13.99
09 – 98	11.47	12.77	9.15	10.45	13.91	15.21	11.05	11.57	8.73	9.25	13.49	14.01
11 – 01	14.98	17.92	12.01	14.95	18.17	21.11	14.32	16.32	11.35	13.35	17.51	19.51
11 – 02	14.61	17.15	11.64	14.18	17.80	20.34	13.99	15.59	11.02	12.62	17.18	18.78
11 – 04	14.80	17.86	11.83	14.89	17.99	21.05	14.24	16.26	11.27	13.29	17.43	19.45
11 – 05	14.83	18.04	11.86	15.07	19.48	21.23	14.13	16.04	11.16	13.07	17.32	19.23
11 – 22	14.47	16.89	11.50	13.92	17.66	20.08	14.19	15.89	11.22	12.92	17.38	19.08
11 – 35	14.73	18.20	11.76	15.23	17.68	21.39	13.82	14.95	10.85	11.98	17.01	18.14
11 – 80	18.30	21.90	15.30	18.90	21.50	28.39	13.80	14.90	10.80	11.90	17.00	18.10
11 – 98	14.70	17.46	11.73	14.49	17.89	20.65	13.86	15.06	10.89	12.09	17.05	18.25
11 – 99	14.87	18.09	11.90	15.12	18.06	21.28	13.89	15.29	10.92	12.32	17.08	18.48
13 – 04	21.04	24.82	15.71	19.49	24.14	27.92	19.80	21.70	14.47	16.37	22.90	24.80
13 – 08	21.42	26.60	16.09	21.27	24.52	29.70	20.30	23.40	14.97	18.07	23.40	26.50
13 – 26	21.79	27.44	16.46	22.11	24.89	30.54	20.05	22.74	14.72	17.41	23.15	25.84
13 – 35	21.22	26.99	15.89	21.66	24.32	30.09	19.68	21.49	14.35	16.16	22.78	24.59
13 – 98	21.08	25.70	15.75	20.37	24.18	28.80	19.68	21.70	14.35	16.37	22.78	24.80
15 – 05	26.04	31.38	19.54	24.88	29.62	34.96	24.49	27.48	17.99	20.98	28.07	31.06
15 – 15	26.84	34.00	20.34	27.50	30.42	37.58	24.57	27.62	18.07	21.12	28.15	31.20
15 – 18	27.05	35.93	20.55	29.43	30.63	39.51	24.53	28.73	18.03	22.23	28.11	32.31
15 – 19	26.58	34.31	20.08	27.81	30.16	37.89	23.92	26.71	17.42	20.21	27.50	30.29
15 – 35	26.68	35.92	20.18	29.42	30.26	39.50	24.09	26.67	17.59	20.17	27.67	30.25
15 – 97	26.51	33.56	20.01	27.06	30.09	37.14	24.15	27.24	17.65	20.74	27.73	30.82
17 – 02	32.96	46.30	31.26	44.60	42.06	55.40	25.80	29.80	24.10	28.10	34.90	38.90
17 – 06	29.90	39.50	28.21	37.81	39.00	48.60	25.94	29.90	24.25	28.21	35.04	39.00
17 – 08	28.89	37.62	27.20	35.93	37.99	46.72	26.41	31.38	24.72	29.69	35.51	40.48
17 – 26	29.47	40.26	27.78	38.57	38.57	49.36	25.83	29.86	24.14	28.17	34.93	38.96
17 – 35	29.71	43.26	28.02	41.57	38.81	52.36	25.86	29.51	24.17	27.82	34.96	38.61
17 – 75	35.31	46.60	33.62	44.91	44.41	55.70	26.31	32.60	24.62	30.91	35.41	41.70
17 – 99	29.52	40.08	27.83	38.39	38.62	49.18	25.96	30.12	24.27	28.43	35.06	39.22
19 – 11	37.77	51.36	31.07	44.66	44.62	58.21	34.36	42.78	27.66	46.43	30.86	49.63
19 – 32	36.98	50.38	30.28	43.68	43.83	57.23	32.50	37.58	25.80	41.23	29.00	44.43
19 – 35	37.29	53.74	30.59	47.04	44.14	44.09	32.67	37.24	25.97	40.89	29.17	44.09
21 – 11	45.51	65.35	39.31	59.15	53.19	73.03	38.25	47.75	32.05	51.93	35.55	55.43
21 – 16	42.61	57.89	36.41	51.69	50.29	65.57	37.65	45.41	31.45	49.59	34.95	53.09
21 – 35	42.89	63.55	36.69	57.35	50.57	71.23	37.36	43.80	31.16	47.98	34.66	51.48
21 – 39	44.27	64.60	38.07	58.40	51.95	72.28	38.47	48.24	32.27	52.42	35.77	55.92
21 – 41	42.81	60.18	36.61	64.36	50.49	67.86	37.07	43.78	30.87	47.96	34.37	51.46
21 – 48	49.59	49.93	43.39	43.73	55.27	57.61	36.48	43.38	30.28	37.18	44.16	51.06
21 – 75	54.48	71.38	48.28	65.18	62.16	79.06	36.48	43.38	30.28	37.18	44.16	51.06
23 – 21	50.49	73.74	44.19	67.44	59.23	82.48	43.98	57.36	37.68	62.20	41.58	66.10
23 – 35	48.85	75.00	42.55	68.70	57.59	83.74	41.85	50.00	35.55	54.84	39.45	58.74
23 – 53	48.91	71.10	42.61	64.80	57.65	79.84	41.49	49.90	35.19	54.74	39.09	58.64
23 – 55	49.66	72.73	43.36	66.43	58.40	81.47	41.96	50.73	35.66	55.57	39.56	59.47
25 – 07	61.89	90.70	55.73	85.10	71.15	99.10	46.41	56.20	40.25	61.26	44.45	65.46
25 – 11	54.48	71.38	48.28	65.18	62.16	79.06	36.48	43.38	42.94	55.94	58.36	71.36
25 – 19	59.76	91.77	53.60	85.61	69.02	101.03	47.22	61.37	41.06	66.43	45.26	70.63
25 – 24	59.26	90.62	53.10	84.46	68.52	99.88	47.62	62.06	41.46	67.12	45.66	71.32
25 – 29	57.58	86.55	51.42	80.39	66.84	95.81	48.59	63.93	42.43	68.99	46.63	73.19
25 – 35	55.37	88.20	49.21	82.04	64.63	97.46	46.41	56.20	40.25	61.26	44.45	65.46
25 – 37	57.57	89.86	51.41	59.36	66.83	90.06	46.10	61.00	39.94	60.50	55.36	61.20
25 – 44	52.80	67.61	46.53	65.39	62.05	83.39	44.40	59.22	38.14	57.00	53.66	75.00
25 – 43	57.62	88.30	51.46	82.14	66.88	97.56	48.20	63.50	42.04	68.56	46.24	72.76
25 – 46	59.92	83.76	53.76	77.60	69.18	93.02	45.28	55.44	39.12	60.50	43.32	64.70
25 – 61	54.67	81.42	48.51	75.26	63.93	90.68	46.13	57.02	39.97	62.08	44.17	66.28
25 – 08	81.00	112.83	74.84	106.67	90.26	122.09	45.00	56.83	38.84	61.69	43.04	66.09
25 – 20	66.02	96.24	59.86	90.08	75.28	105.50	44.45	54.70	38.29	59.76	42.49	63.96
25 – 04	58.42	88.27	52.26	82.11	67.68	97.53	49.22	62.83	43.06	67.89	47.26	72.09

Weight in gram (+/- 15%)