

## Wirewound Resistors

### Industrial Power, Tubular (HL), Non-Inductive Tubular (NHL)

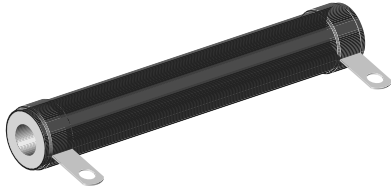

**FEATURES**

- High temperature silicon coating
- Complete welded construction
- Available in non-inductive styles (model NHL) with Aryton-Perry winding
- Tight tolerance of 5 % for values above 1 Ω
- Excellent stability in operation (< 3 % change in resistance)



**RoHS\***  
COMPLIANT

STANDARD ELECTRICAL SPECIFICATIONS					
GLOBAL MODEL	HISTORICAL MODEL	POWER RATING P <sub>25 °C</sub> W	RESISTANCE RANGE Ω		WEIGHT (Typical) g
			± 5 %	± 10 %	
HL011 NHL011	HL-11 NHL-11	11	1.0 - 70K 1.0 - 4.7K	0.10 - 70K 1.0 - 4.7K	10.50
HL012 NHL012	HL-12 NHL-12	12	1.0 - 58K 1.0 - 3.9K	0.10 - 58K 1.0 - 3.9K	6.69
HL015 NHL015	HL-15 NHL-15	15	1.0 - 60K 1.0 - 4.3K	0.10 - 60K 1.0 - 4.3K	8.64
HL020 NHL020	HL-20 NHL-20	20	1.0 - 95K 1.0 - 6.8K	0.10 - 95K 1.0 - 6.8K	12.57
HL025 NHL025	HL-25 NHL-25	25	1.0 - 115K 1.0 - 8.8K	0.10 - 115K 1.0 - 8.8K	20.72
HL026 NHL026	HL-26 NHL-26	26	1.0 - 170K 1.0 - 11.8K	0.10 - 170K 1.0 - 11.8K	15.34
HL050 NHL050	HL-50 NHL-50	50	1.0 - 112K 1.0 - 21.5K	0.10 - 112K 1.0 - 21.5K	42.08
HL051 NHL051	HL-51 NHL-51	51	1.0 - 124K 1.0 - 22.9K	0.10 - 124K 1.0 - 22.9K	51.96
HL060 NHL060	HL-60 NHL-60	60	1.0 - 145K 1.0 - 27.2K	0.10 - 145K 1.0 - 27.2K	65.64
HL065 NHL065	HL-65 NHL-65	65	1.0 - 170K 1.0 - 31.4K	0.10 - 170K 1.0 - 31.4K	64.82
HL080 NHL080	HL-80 NHL-80	80	1.0 - 190K 1.0 - 38.3K	0.10 - 190K 1.0 - 38.3K	121.58
HL100 NHL100	HL-100 NHL-100	100	1.0 - 260K 1.0 - 48.5K	0.10 - 260K 1.0 - 48.5K	91.37
HL120 NHL120	HL-120 NHL-120	120	1.0 - 330K 1.0 - 64.1K	0.10 - 330K 1.0 - 64.1K	183.82
HL130 NHL130	HL-130 NHL-130	130	1.0 - 380K 1.0 - 70.2K	0.10 - 380K 1.0 - 70.2K	192.36
HL160 NHL160	HL-160 NHL-160	160	1.0 - 470K 1.0 - 105K	0.10 - 470K 1.0 - 105K	245.86
HL175 NHL175	HL-175 NHL-175	175	1.0 - 500K 1.0 - 112K	0.10 - 500K 1.0 - 112K	250.80
HL225 NHL225	HL-225 NHL-225	225	1.0 - 645K 1.0 - 121K	0.10 - 645K 1.0 - 121K	309.97

GLOBAL PART NUMBER INFORMATION						
New Global Part Numbering: NHL10006Z10R00JJ (preferred part number format)						
N	H	L	1	0	0	0
6	Z	1	0	R	0	0
J	J					
GLOBAL MODEL	TERMINAL DESIGNATION	TERMINAL FINISH	RESISTANCE VALUE	TOLERANCE	PACKAGING CODE	SPECIAL
NHL100 <small>(See "Standard Electrical Specifications" table above for additional P/N's)</small>	02 05 06 07 14 15	E = Lead (Pb)-free Z = Tin/Lead N = Nickel	R = Decimal K = Thousand 10R00 = 10.0 Ω 1K000 = 1 kΩ	J = ± 5.0 % K = ± 10.0 % <small>* Tin/Lead for type "Z", lead (Pb)-free for type "N"</small>	E = Lead (Pb)-free skin pack J* = Skin pack (J01)	(Dash Number) (up to 2 digits) From 1 - 99 as applicable
Historical Part Number example: NHL-100-06Z 10 Ω 5 % J01 (will continue to be accepted)						
NHL-100	06Z	10 Ω	5 %	J01		
HISTORICAL MODEL	TERMINAL/FINISH	RESISTANCE VALUE	TOLERANCE	PACKAGING		

\* Pb containing terminations are not RoHS compliant, exemptions may apply

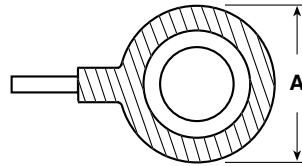
**DIMENSIONS**

(Includes Coating and Terminal Band)

GLOBAL MODEL	DIMENSIONS in inches [millimeters]								
	A (Max.)	CORE DIMENSIONS			TERMINAL SETBACK $\pm 0.31$ [ $\pm 0.79$ ]	DISTANCE BETWEEN TERMINALS (REF)	TERMINAL DESIGNATION		MOUNTING HARDWARE OPTIONS
		LENGTH $\pm 0.062$ [ $\pm 1.59$ ]	O.D.	I.D. $\pm 0.031$ [ $\pm 0.79$ ]			STANDARD	OPTIONAL	
HL011	0.469	1.750	0.375	0.188	0.094	1.187	02	-	101, 204, 301
NHL011	[11.91]	[44.45]	[9.53]	[4.76]	[2.38]				
HL012	0.406	1.750	0.313	0.188	0.094	1.187	05	14	101, 204, 301
NHL012	[10.32]	[44.45]	[7.94]	[4.76]	[2.38]				
HL015	0.563	1.500	0.438	0.313	0.094	0.937	02	14	101, 203, 301
NHL015	[14.29]	[38.10]	[11.11]	[7.94]	[2.38]				
HL020	0.563	2.000	0.438	0.313	0.094	1.437	02	14	101, 203, 301
NHL020	[14.29]	[50.8]	[11.11]	[7.94]	[2.38]				
HL025	0.688	2.000	0.563	0.313	0.094	1.312	06	15	101, 203, 301
NHL025	[17.46]	[50.8]	[14.29]	[7.94]	[2.38]				
HL026	0.563	3.000	0.438	0.313	0.094	2.437	02	14	101, 203, 301
NHL026	[14.29]	[76.2]	[11.11]	[7.94]	[2.38]				
HL050	0.688	4.000	0.563	0.313	0.094	3.312	06	15	101, 203, 301
NHL050	[17.46]	[101.6]	[14.29]	[7.94]	[2.38]				
HL051	0.906	3.500	0.750	0.500	0.125	2.75	06	15	102, 206, 303
NHL051	[23.02]	[88.9]	[19.05]	[12.70]	[3.18]				
HL060	0.906	4.000	0.750	0.500	0.125	3.250	06	15	102, 206, 303
NHL060	[23.02]	[101.6]	[19.05]	[12.70]	[3.18]				
HL065	0.906	4.500	0.750	0.500	0.125	3.750	06	15	102, 206, 303
NHL065	[23.02]	[114.3]	[19.05]	[12.70]	[3.18]				
HL080	1.313	4.000	1.125	0.750	0.219	2.812	07	15	103, 205, 303
NHL080	[33.34]	[101.6]	[28.58]	[19.05]	[5.56]				
HL100	0.906	6.500	0.750	0.500	0.125	5.750	06	15	102, 206, 303
NHL100	[23.02]	[165.1]	[19.05]	[12.70]	[3.18]				
HL120	1.313	6.000	1.125	0.750	0.219	4.812	07	15	103, 205, 303
NHL120	[33.34]	[152.4]	[28.58]	[19.05]	[5.56]				
HL130	1.313	6.500	1.125	0.750	0.219	5.312	07	15	103, 205, 303
NHL130	[33.34]	[165.1]	[28.58]	[19.05]	[5.56]				
HL160	1.313	8.000	1.125	0.750	0.219	6.812	07	15	103, 205, 303
NHL160	[33.34]	[203.2]	[28.58]	[19.05]	[5.56]				
HL175	1.313	8.500	1.125	0.750	0.219	7.312	07	15	103, 205, 303
NHL175	[33.34]	[215.9]	[28.58]	[19.05]	[5.56]				
HL225	1.313	10.500	1.125	0.750	0.219	9.312	07	15	103, 205, 303
NHL225	[33.34]	[266.7]	[28.58]	[19.05]	[5.56]				

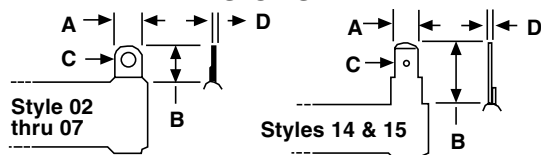
**TERMINAL DIMENSIONS**

**TERMINAL FINISH** - "E" Finish - 100 % Sn coated steel. "Z" Finish - 60/40 SnPb coated steel. "N" Finish - Nickel coated steel. Finish for terminal style 14 and 15 limited to nickel plated steel (N).

DIMENSION	TERMINAL TYPE					
	02	05	06	07	14	15
A	0.188 [4.76]	0.188 [4.76]	0.250 [6.35]	0.375 [9.53]	0.188 [4.76]	0.250 [6.35]
B	0.406 [10.32]	0.438 [11.11]	0.563 [14.29]	0.625 [15.88]	0.563 [14.29]	0.594 [15.08]
C	0.093 [2.36]	0.104 [2.64]	0.166 [4.22]	0.173 [4.39]	0.050 [1.27]	0.065 [1.65]
D	0.020 [0.51]	0.020 [0.51]	0.020 [0.51]	0.020 [0.51]	0.020 [0.51]	0.031 [0.79]

## MOUNTING HARDWARE DIMENSIONS in inches [millimeters]

### Horizontal Thru-Bolt

(Threaded Rod Supplied as Standard on HL050 thru HL225 sizes.)

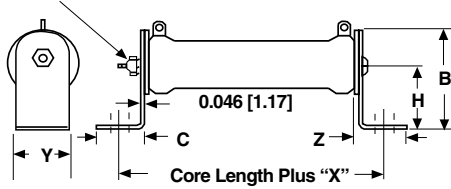

BRACKET TYPE	X	Y	Z	H	MOUNTING SLOT	C	B
101	1.063 [26.99]	0.500 [12.70]	0.859 [21.83]	1.000 [25.40]	0.219 x 0.438 [5.56 x 11.11]	0.750 [19.05]	1.375 [34.93]
102	1.063 [26.99]	0.750 [19.05]	0.859 [21.83]	1.250 [31.75]	0.219 x 0.438 [5.56 x 11.11]	0.750 [19.05]	1.750 [44.45]
103	1.063 [26.99]	1.250 [31.75]	1.000 [25.40]	1.500 [38.10]	0.281 x 0.563 [7.14 x 14.29]	0.875 [22.23]	2.125 [53.98]

### Push-In

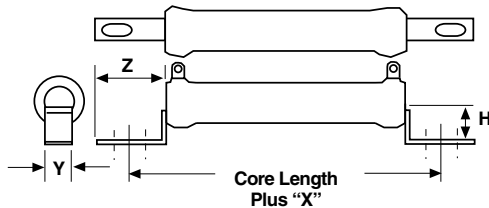

BRACKET TYPE	X	H	Y	Z	HOLE (DIA)
203	0.625 [15.88]	0.672 [17.07]	0.250 [6.35]	0.469 [11.91]	0.161 [4.09]
204	0.375 [9.53]	0.281 [7.14]	0.250 [6.35]	0.344 [8.73]	0.144 [3.66]
205	0.813 [20.64]	1.391 [35.32]	0.500 [12.70]	0.688 [17.46]	0.196 x 0.260 [4.98 x 6.60]
206	0.719 [18.26]	0.969 [24.61]	0.375 [9.53]	0.625 [15.88]	0.196 x 0.260 [4.98 x 6.60]

### Vertical Thru-Bolt

(Threaded Rod Supplied as Standard on HL050 thru HL225 sizes.)

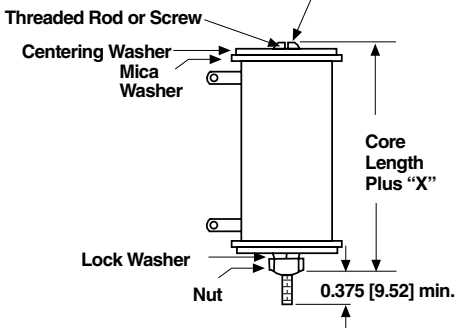

BRACKET TYPE	X (Approximate)	THREAD
301	0.438 [11.11]	8-32
303	0.500 [12.70]	10-32

TECHNICAL SPECIFICATIONS		
PARAMETER	UNIT	HL, NHL RESISTOR CHARACTERISTICS
Temperature Coefficient	ppm/°C	± 90 for 0.1 Ω to 0.99 Ω; ± 50 for 1 Ω to 9.9 Ω; ± 30 for 10 Ω and above
Dielectric Withstanding Voltage	V <sub>AC</sub>	1000, from terminal to mounting hardware
Short Time Overload	-	10 × rated power for 5 seconds
Maximum Working Voltage	V	(P × R) <sup>1/2</sup>
Insulation Resistance	Ω	1000 Megohms minimum dry, 100 Megohm minimum after moisture test
Operating Temperature Range	°C	- 55/+ 350



**MATERIAL SPECIFICATIONS**

**Element:** Copper-nickel alloy of nickel-chrome alloy, depending on resistance value

**Core:** Ceramic, steatite

**Coating:** Special high temperature silicone

**Standard Terminals:** Model "Z" terminals are tinned steel

**Terminal Bands:** Steel

**Part Marking:** DALE, Model, Wattage, Value, Tolerance, Date Code

**NHL NON-INDUCTIVE**

Models of equivalent physical and electrical specifications are available with non-inductive (Aryton-Perry) winding. They are identified by adding the letter N to the front of the HL type designation (NHL-225 for example). For NHL models maximum resistance values are lower, see STANDARD ELECTRICAL SPECIFICATIONS table.

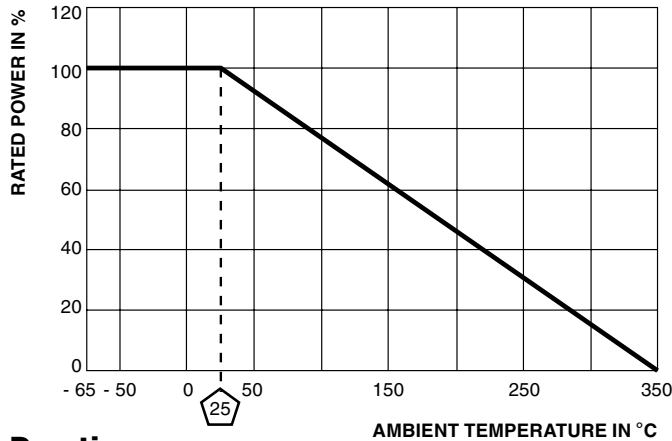

**Derating**

<b>PERFORMANCE</b>		
<b>TEST</b>	<b>CONDITIONS OF TEST</b>	<b>TEST LIMITS</b>
Thermal Shock	Rated power applied until thermally stable, then a minimum of 15 minutes at - 55 °C	± (2.0 % + 0.05 Ω) ΔR
Short Time Overload	10 x rated power for 5 seconds	± (2.0 % + 0.05 Ω) ΔR
Dielectric Withstanding Voltage	1000 V <sub>rms</sub> , 1 minute	± (0.1 % + 0.05 Ω) ΔR
Low Temperature Storage	- 55 °C for 24 hours	± (2.0 % + 0.05 Ω) ΔR
High Temperature Exposure	250 hours at + 350 °C	± (2.0 % + 0.05 Ω) ΔR
Moisture Resistance	MIL-STD-202 Method 106, 7b not applicable	± (2.0 % + 0.05 Ω) ΔR
Shock, Specified Pulse	MIL-STD-202 Method 213, 100 g's for 6 milliseconds, 10 shocks	± (0.2 % + 0.05 Ω) ΔR
Vibration, High Frequency	Frequency varied 10 to 2000 Hz, 20 g peak, 2 directions 6 hours each	± (0.2 % + 0.05 Ω) ΔR
Load Life	1000 hours at rated power, + 25 °C, 1.5 hours "ON", 0.5 hours "OFF"	± (3.0 % + 0.05 Ω) ΔR