

Speed TEMPFET®

- N-Channel
- Enhancement mode
- Logic Level Input
- Analog driving possible
- Fast switching up to 1 MHz
- Potential-free temperature sensor with thyristor characteristics
- Overtemperature protection
- Avalanche rated

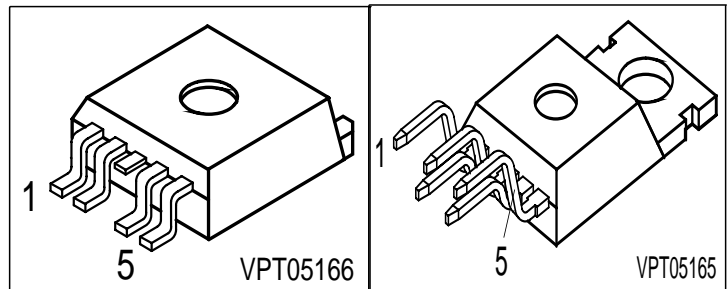

Type	V_{DS}	$R_{DS(on)}$	Package	Marking	Ordering Code
BTS 244 Z	55 V	13 mΩ	TO-220 AB	-	Q67060-S6000
			TO-220-5 SMD		Q67060-S6003

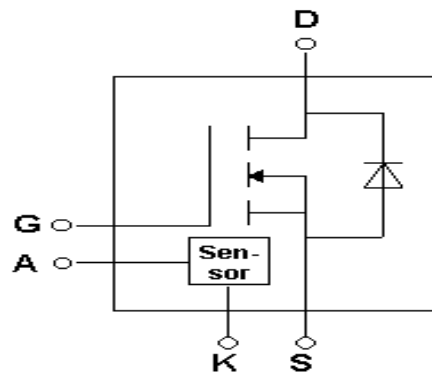

Pin	Symbol	Function
1	G	Gate
2	A	Anode Temperature Sensor
3	D	Drain
4	K	Cathode Temperature Sensor
5	S	Source

Maximum Ratings, at $T_j = 25^\circ\text{C}$ unless otherwise specified

Parameter	Symbol	Value	Unit
Drain source voltage	V_{DS}	55	V
Drain-gate voltage, $R_{GS} = 20\text{ k}\Omega$	V_{DGR}	55	
Gate source voltage	V_{GS}	± 14	
Nominal load current (ISO 10483) $V_{GS} = 4.5\text{ V}$, $V_{DS} \leq 0.5\text{ V}$, $T_C = 85^\circ\text{C}$ $V_{GS} = 10\text{ V}$, $V_{DS} \leq 0.5\text{ V}$, $T_C = 85^\circ\text{C}$	$I_{D(ISO)}$	19 26	A
Continuous drain current ¹⁾ $T_C = 100^\circ\text{C}$, $V_{GS} = 4.5\text{V}$	I_D	35	
Pulsed drain current	$I_{D\text{ puls}}$	188	
Avalanche energy, single pulse $I_D = 19\text{ A}$, $R_{GS} = 25\ \Omega$	E_{AS}	1.65	J
Power dissipation $T_C = 25^\circ\text{C}$	P_{tot}	170	W
Operating temperature ²⁾	T_j	-40 ... +175	$^\circ\text{C}$
Storage temperature	T_{stg}	-55 ... +150	
DIN humidity category, DIN 40 040		E	
IEC climatic category; DIN IEC 68-1		40/150/56	

¹current limited by bond wire

²Note: Thermal trip temperature of temperature sensor is below 175°C

Electrical Characteristics

Parameter at $T_j = 25^\circ\text{C}$, unless otherwise specified	Symbol	Values			Unit
		min.	typ.	max.	

Thermal Characteristics

junction - case:	R_{thJC}	-	-	0.88	K/W
Thermal resistance @ min. footprint	$R_{th(JA)}$	-	-	62	
Thermal resistance @ 6 cm ² cooling area ¹⁾	$R_{th(JA)}$	-	33	-	

Static Characteristics

Drain- source breakdown voltage $V_{GS} = 0\text{ V}$, $I_D = 0.25\text{ mA}$	$V_{(BR)DSS}$	55	-	-	V
Gate threshold voltage, $V_{GS} = V_{DS}$ $I_D = 130\ \mu\text{A}$ $I_D = 250\ \mu\text{A}$	$V_{GS(th)}$	1.2 -	1.6 1.65	2 -	
Zero gate voltage drain current $V_{DS} = 50\text{ V}$, $V_{GS} = 0\text{ V}$, $T_j = -40\ ^\circ\text{C}$ $V_{DS} = 50\text{ V}$, $V_{GS} = 0\text{ V}$, $T_j = 25\ ^\circ\text{C}$ $V_{DS} = 50\text{ V}$, $V_{GS} = 0\text{ V}$, $T_j = 150\ ^\circ\text{C}$	I_{DSS}	- - -	- 0.1 -	0.1 1 100	μA
Gate-source leakage current $V_{GS} = 20\text{ V}$, $V_{DS} = 0\text{ V}$, $T_j = 25\ ^\circ\text{C}$ $V_{GS} = 20\text{ V}$, $V_{DS} = 0\text{ V}$, $T_j = 150\ ^\circ\text{C}$	I_{GSS}	- -	10 20	100 100	nA
Drain-Source on-state resistance $V_{GS} = 4.5\text{ V}$, $I_D = 19\text{ A}$ $V_{GS} = 10\text{ V}$, $I_D = 19\text{ A}$	$R_{DS(on)}$	- -	16 11.5	18 13	m Ω

¹ Device on 50mm*50mm*1.5mm epoxy PCB FR4 with 6cm² (one layer, 70 μm thick) copper area for drain connection. PCB mounted vertical without blown air.

Electrical Characteristics

Parameter at $T_j = 25^\circ\text{C}$, unless otherwise specified	Symbol	Values			Unit
		min.	typ.	max.	

Dynamic Characteristics

Forward transconductance $V_{DS} > 2 \cdot I_D \cdot R_{DS(on)max}$, $I_D = 35\text{ A}$	g_{fs}	25	-	-	S
Input capacitance $V_{GS} = 0\text{ V}$, $V_{DS} = 25\text{ V}$, $f = 1\text{ MHz}$	C_{iss}	-	2130	2660	pF
Output capacitance $V_{GS} = 0\text{ V}$, $V_{DS} = 25\text{ V}$, $f = 1\text{ MHz}$	C_{oss}	-	600	750	
Reverse transfer capacitance $V_{GS} = 0\text{ V}$, $V_{DS} = 25\text{ V}$, $f = 1\text{ MHz}$	C_{rss}	-	320	400	
Turn-on delay time $V_{DD} = 30\text{ V}$, $V_{GS} = 4.5\text{ V}$, $I_D = 47\text{ A}$, $R_G = 2.2\ \Omega$	$t_{d(on)}$	-	15	25	ns
Rise time $V_{DD} = 30\text{ V}$, $V_{GS} = 4.5\text{ V}$, $I_D = 47\text{ A}$, $R_G = 2.2\ \Omega$	t_r	-	70	105	
Turn-off delay time $V_{DD} = 30\text{ V}$, $V_{GS} = 4.5\text{ V}$, $I_D = 47\text{ A}$, $R_G = 2.2\ \Omega$	$t_{d(off)}$	-	40	60	
Fall time $V_{DD} = 30\text{ V}$, $V_{GS} = 4.5\text{ V}$, $I_D = 47\text{ A}$, $R_G = 2.2\ \Omega$	t_f	-	25	40	

Gate Charge Characteristics

Gate charge at threshold $V_{DD} = 40\text{ V}$, $I_D = 0.1\text{ A}$, $V_{GS} = 0\text{ to }1\text{ V}$	$Q_{g(th)}$	-	2.5	3.8	nC
Gate charge at 5.0 V $V_{DD} = 40\text{ V}$, $I_D = 47\text{ A}$, $V_{GS} = 0\text{ to }5\text{ V}$	$Q_{g(5)}$	-	50	75	
Gate charge total $V_{DD} = 40\text{ V}$, $I_D = 47\text{ A}$, $V_{GS} = 0\text{ to }10\text{ V}$	$Q_{g(total)}$	-	85	130	
Gate plateau voltage $V_{DD} = 40\text{ V}$, $I_D = 47\text{ A}$	$V_{(plateau)}$	-	4.5	-	V

Electrical Characteristics

Parameter at $T_j = 25^\circ\text{C}$, unless otherwise specified	Symbol	Values			Unit
		min.	typ.	max.	
Reverse Diode					
Inverse diode continuous forward current $T_C = 25^\circ\text{C}$	I_S	35	-	-	A
Inverse diode direct current, pulsed $T_C = 25^\circ\text{C}$	I_{FM}	188	-	-	
Inverse diode forward voltage $V_{GS} = 0\text{ V}$, $I_F = 94\text{ A}$	V_{SD}	-	1.25	1.8	V
Reverse recovery time $V_R = 30\text{ V}$, $I_F = I_S$, $di_F/dt = 100\text{ A}/\mu\text{s}$	t_{rr}	-	110	165	ns
Reverse recovery charge $V_R = 30\text{ V}$, $I_F = I_S$, $di_F/dt = 100\text{ A}/\mu\text{s}$	Q_{rr}	-	0.23	0.35	nC

Sensor Characteristics

Forward voltage $I_{AK(on)} = 5\text{ mA}$, $T_j = -40\dots+150^\circ\text{C}$	$V_{AK(on)}$	-	1.3	1.4	V
Sensor override $t_P = 100\ \mu\text{s}$, $T_j = -40\dots+150^\circ\text{C}$		-	-	10	
Forward current $T_j = -40\dots+150^\circ\text{C}$	$I_{AK(on)}$	-	-	5	mA
Sensor override $t_P = 100\ \mu\text{s}$, $T_j = -40\dots+150^\circ\text{C}$		-	-	600	
Temperature sensor leakage current $T_j = 150^\circ\text{C}$	$I_{AK(off)}$	-	-	4	μA

Electrical Characteristics

Parameter	Symbol	Values			Unit
		min.	typ.	max.	
Characteristics					
Holding current, $V_{AK(off)} = 5V$ $T_j = 25\text{ }^\circ\text{C}$ $T_j = 150\text{ }^\circ\text{C}$	$I_{AK(hold)}$	0.05 0.05	- -	0.5 0.3	mA
Thermal trip temperature $V_{TS} = 5V$	$T_{TS(on)}$	150	160	170	$^\circ\text{C}$
Turn-off time $V_{TS} = 5V, I_{TS(on)} = 2\text{ mA}$	t_{off}	0.5	-	2.5	μs
Reset voltage $T_j = -40\dots+150\text{ }^\circ\text{C}$	$V_{AK(reset)}$	0.5	-	-	V

On-state resistance

$$R_{ON} = f(T_j); I_D=19A; V_{GS} = 4.5V$$

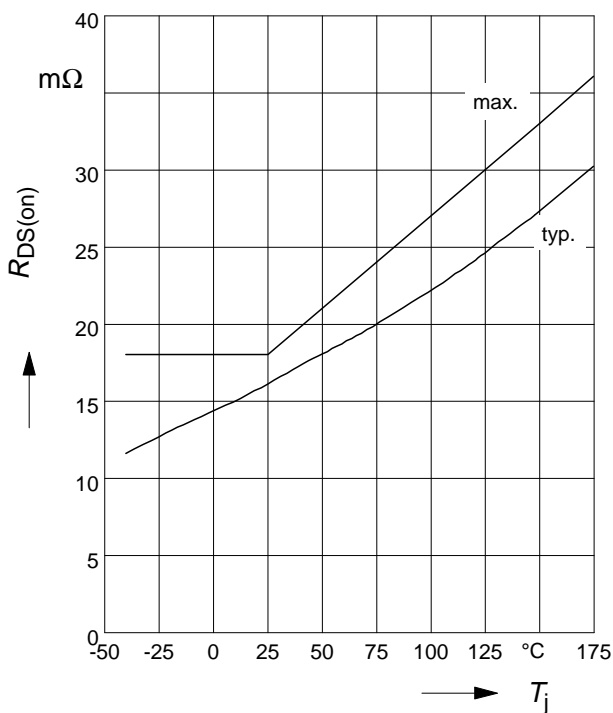

On-state resistance

$$R_{ON} = f(T_j); I_D=19A; V_{GS} = 10V$$

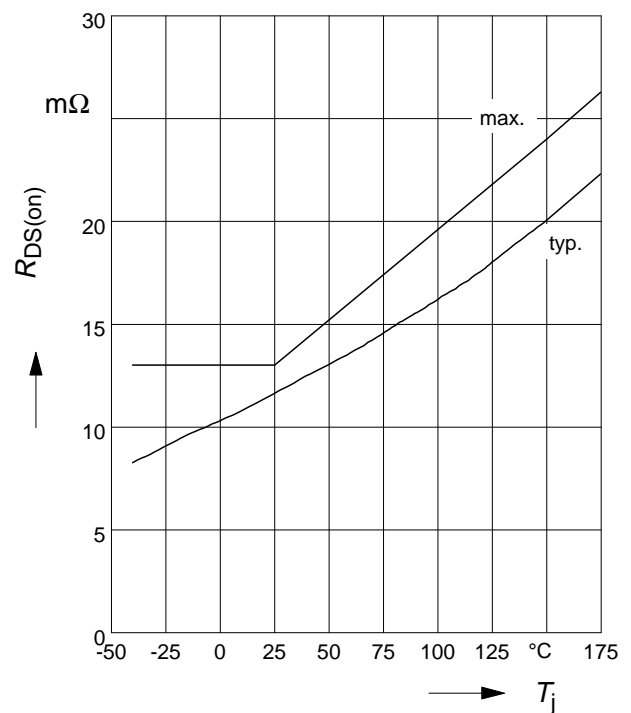

Maximum allowable power dissipation

$$P_{\text{tot}} = f(T_C)$$

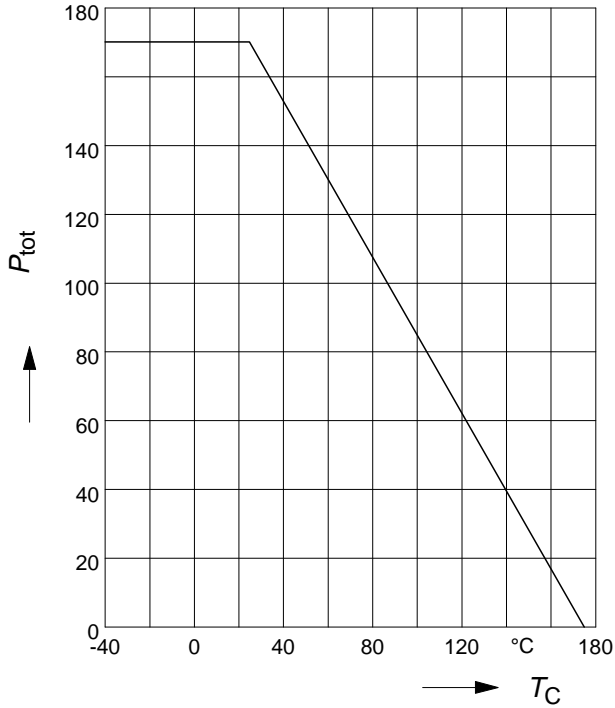

Drain current

$$I_D = f(T_C); V_{GS} \geq 4.5V$$

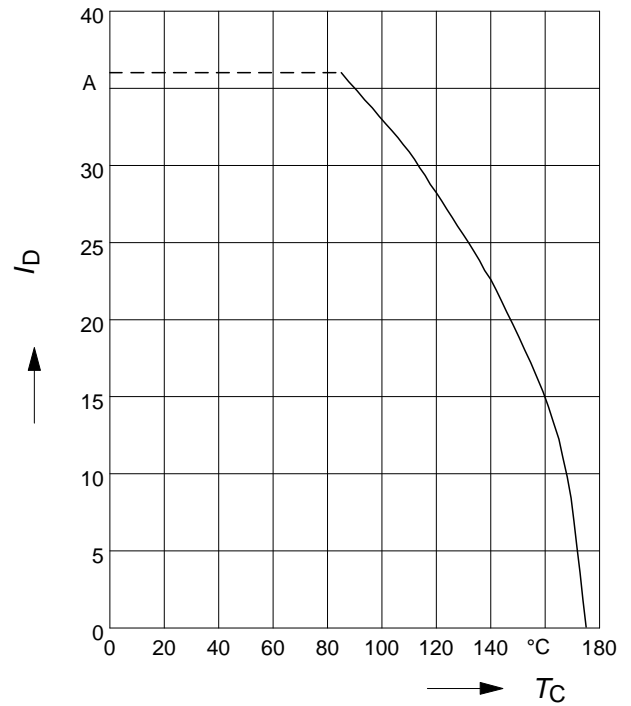

Typ. transient thermal impedance

$$Z_{\text{thJA}} = f(t_p) \text{ @ } 6 \text{ cm}^2 \text{ cooling area}$$

Parameter: $D = t_p / T$

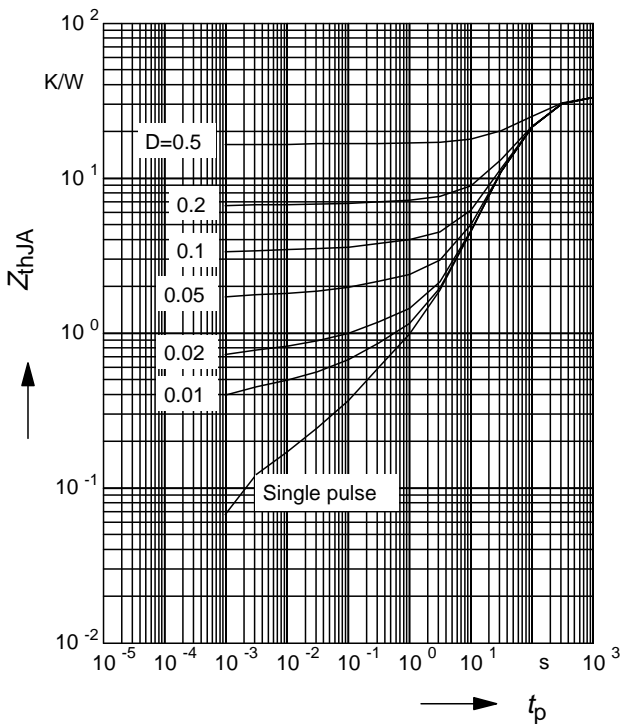

Transient thermal impedance

$$Z_{\text{thJC}} = f(t_p)$$

Parameter: $D = t_p / T$

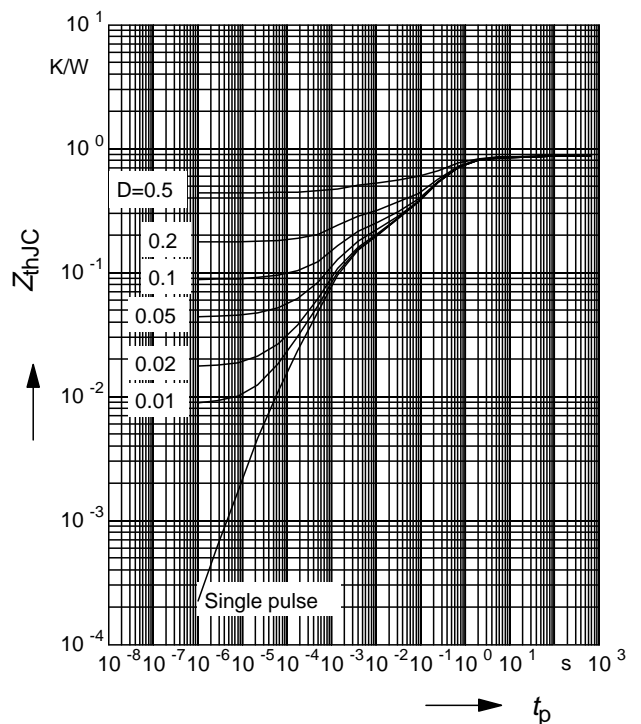

Typ. transfer characteristics

$$I_D = f(V_{GS}); V_{DS} = 12V; T_j = 25^\circ C$$

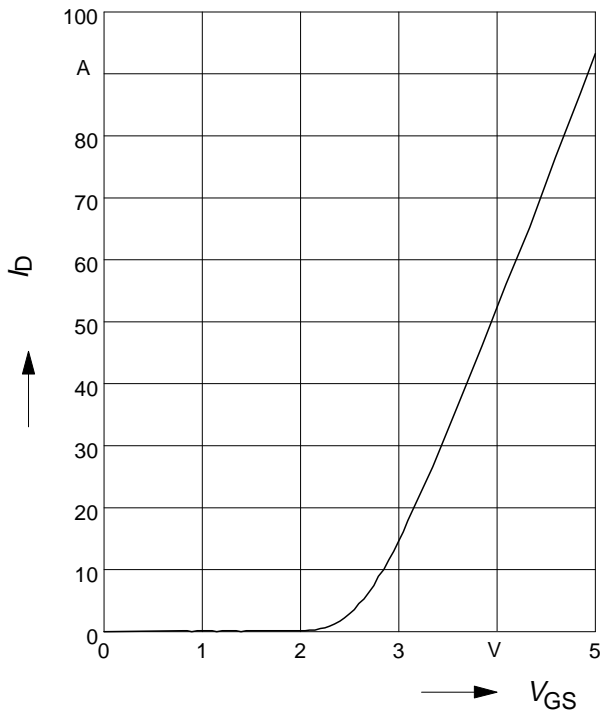

Typ. input threshold voltage

$$V_{GS(th)} = f(T_j); V_{DS} = V_{GS}$$

Parameter: I_D

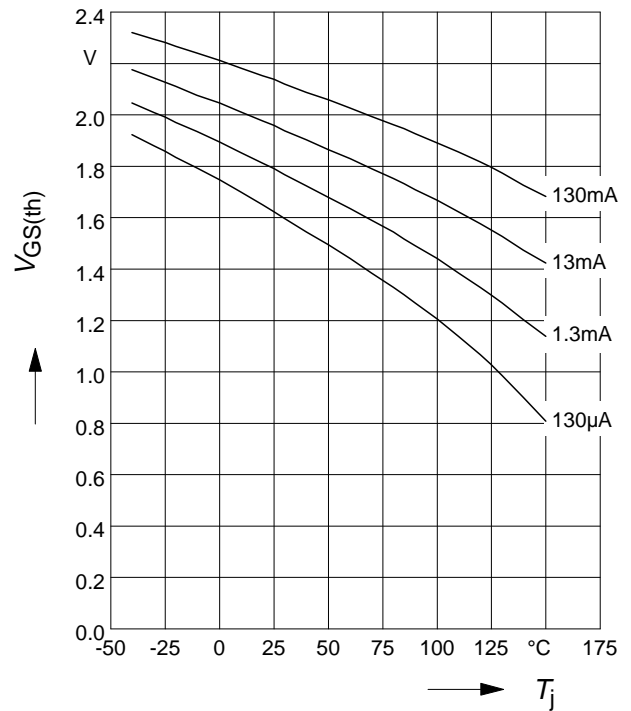

Typ. output characteristic

$$I_D = f(V_{DS}); T_j = 25^\circ C$$

Parameter: V_{GS}

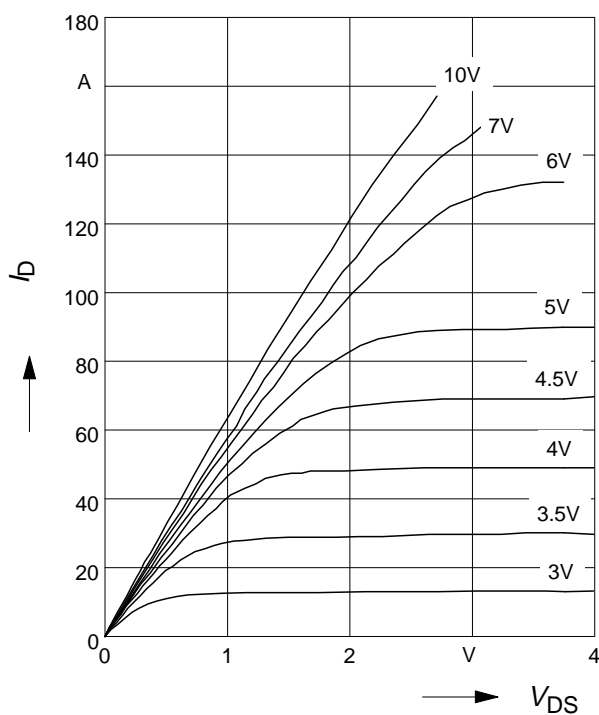

Safe operating area

$$I_D = f(V_{DS}); D = 0.01; T_C = 25^\circ C; V_{GS} = 4.5V$$

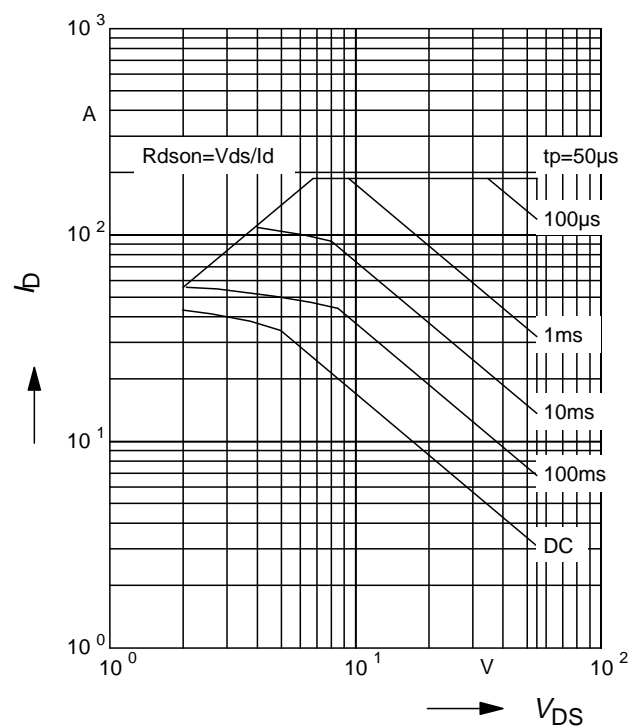

Drain-source break down voltage

$$V_{(BR)DSS} = f(T_j)$$

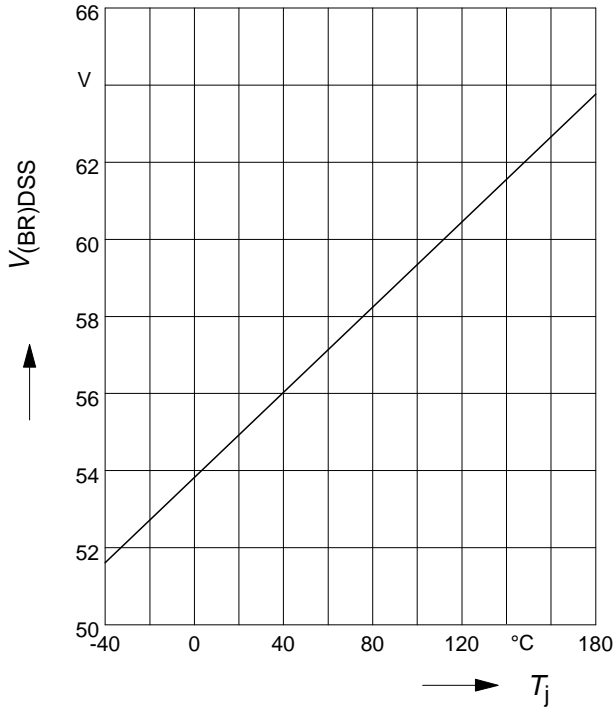

Forward characteristics of reverse diode

$$I_F = f(V_{SD}); t_p = 80\mu s \text{ (spread)}$$

Parameter: T_j

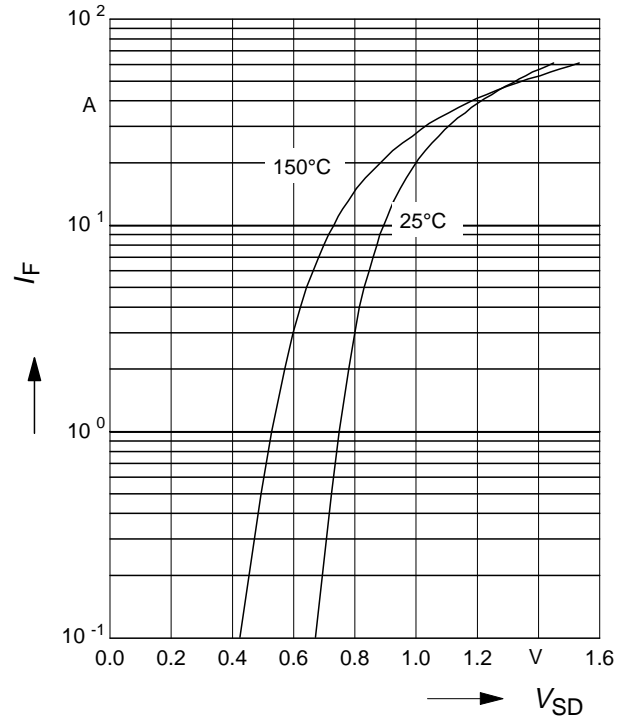

Typ. gate charge

$$V_{GS} = f(Q_{Gate}); I_{D \text{ puls}} = 47A$$

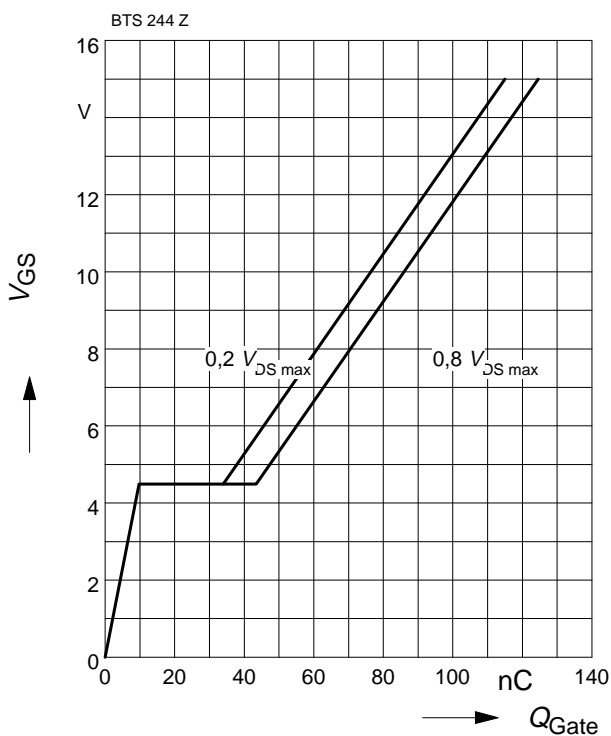

Typ. capacitances

$$C = f(V_{DS}); V_{GS} = 0V, f = 1MHz$$

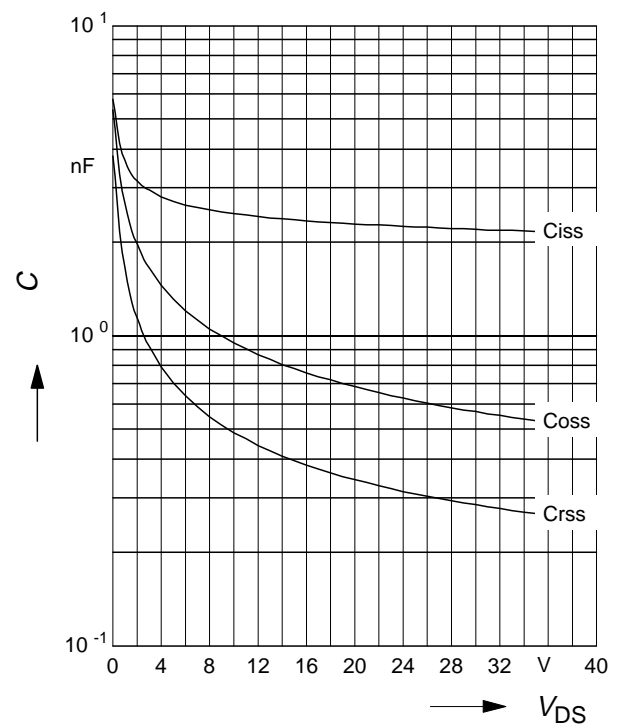

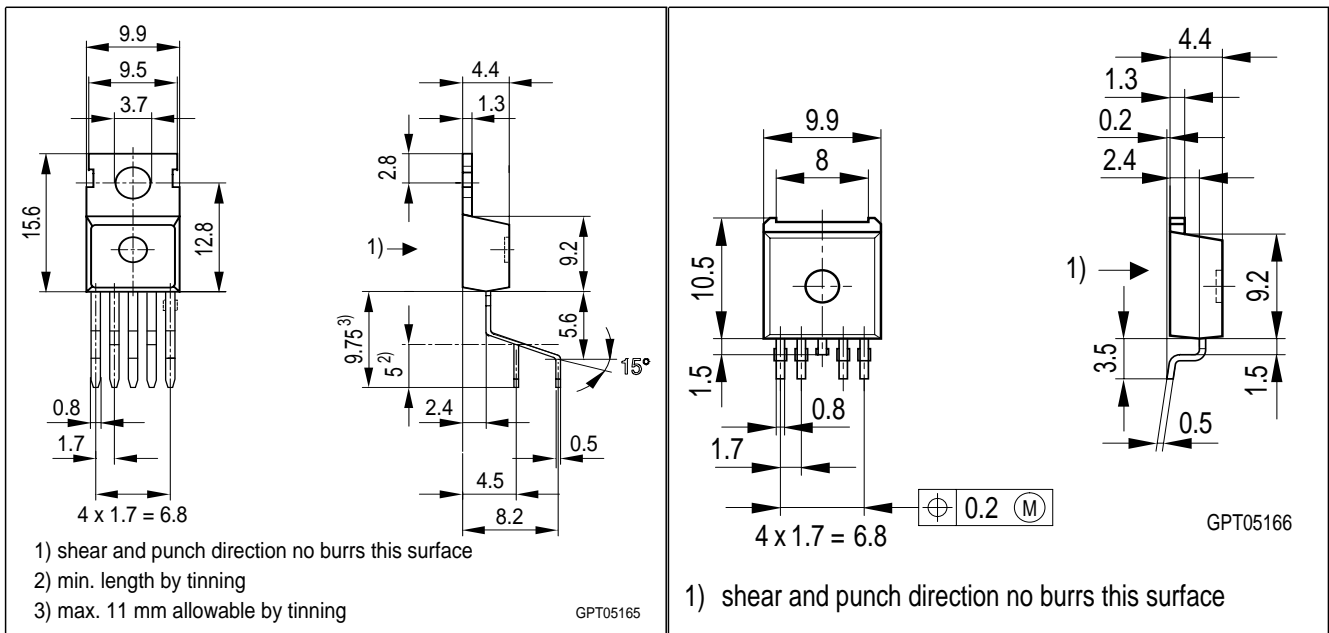

Edition 03 / 1999

**Published by Siemens AG,
 Bereich Halbleiter Vertrieb,
 Werbung, Balanstraße 73,
 81541 München**

© Siemens AG 1997
 All Rights Reserved.

Attention please!

As far as patents or other rights of third parties are concerned, liability is only assumed for components, not for applications, processes and circuits implemented within components or assemblies.

The information describes a type of component and shall not be considered as warranted characteristics.

Terms of delivery and rights to change design reserved.

For questions on technology, delivery and prices please contact the Semiconductor Group Offices in Germany or the Siemens Companies and Representatives worldwide (see address list).

Due to technical requirements components may contain dangerous substances. For information on the types in question please contact your nearest Siemens Office, Semiconductor Group.

Siemens AG is an approved CECC manufacturer.

Packing

Please use the recycling operators known to you. We can also help you - get in touch with your nearest sales office. By agreement we will take packing material back, if it is sorted. You must bear the costs of transport. For packing material that is returned to us unsorted or which we are not obliged to accept, we shall have to invoice you for any costs incurred.

Components used in life-support devices or systems must be expressly authorized for such purpose!

Critical components¹ of the Semiconductor Group of Siemens AG, may only be used in life-support devices or systems² with the express written approval of the Semiconductor Group of Siemens AG.

1) A critical component is a component used in a life-support device or system whose failure can reasonably be expected to cause the failure of that life-support device or system, or to affect its safety or effectiveness of that device or system.

2) Life support devices or systems are intended (a) to be implanted in the human body, or (b) to support and/or maintain and sustain and/or protect human life. If they fail, it is reasonable to assume that the health of the user or other persons may be endangered.