

**1A ULTRA LOW DROPOUT LINEAR REGULATOR**

**AZ2940**

**General Description**

The AZ2940 is a low dropout three-terminal regulator with a typical dropout of 280mV at 1A output current.

The AZ2940 provides current limit and thermal shutdown. On-chip thermal shutdown provides protection against any combination of high current and ambient temperature that would create excessive junction temperatures.

The AZ2940 has 1.2V, 1.8V, 2.5V, 3.3V and 5.0V versions.

The AZ2940 series is available in the industry standard TO-220-3, TO-263-3, TO-252-2 and SOT-223 power packages. (Detailed information please refer to page 4)

**Features**

- Minimum Guaranteed Output Current: 1A
- Dropout Voltage at  $I_{OUT}=1A$ : 280mV Typ. (Except 1.2V and 1.8V Versions)
- Output Accuracy:  $\pm 1\%$
- Low Ground Current
- Internal Current Limit and Thermal Protection
- Reversed-battery and Reversed-lead Insertion Protection
- Fast Transient Response

**Applications**

- LCD TV
- Set Top Box
- LCD Monitor
- SMPS Post Regulator
- Laptop, Palmtop and Notebook
- Portable Instrumentation
- USB Power Supply

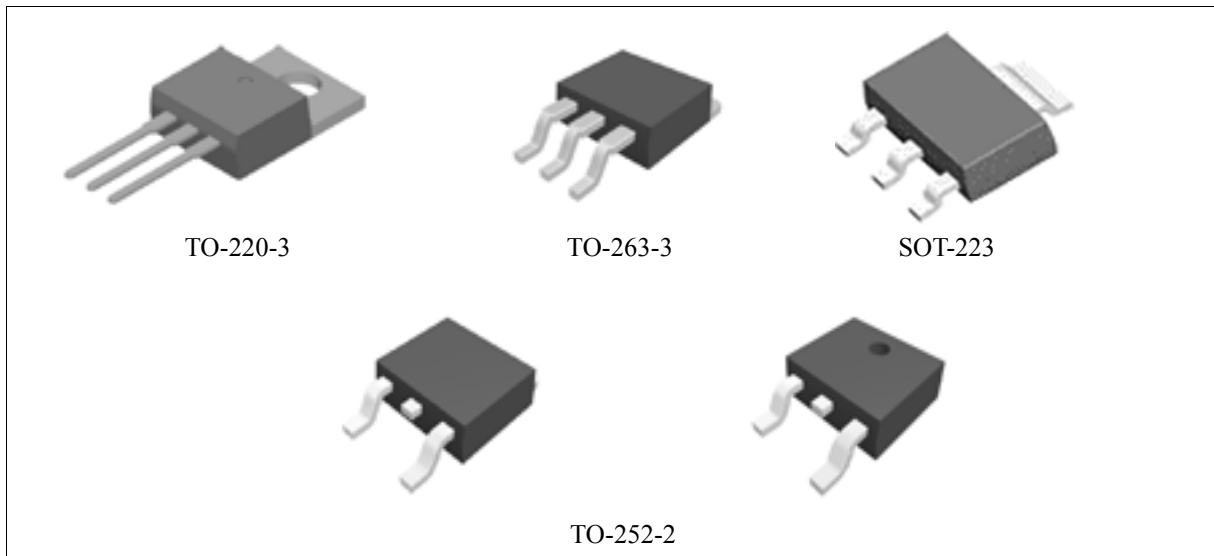

Figure 1. Package Types of AZ2940

**1A ULTRA LOW DROPOUT LINEAR REGULATOR**

**AZ2940**

**Pin Configuration**

T Package  
(TO-220-3)

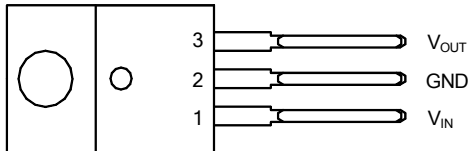

S Package  
(TO-263-3)

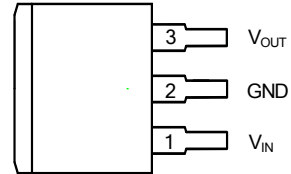

D Package  
(TO-252-2)

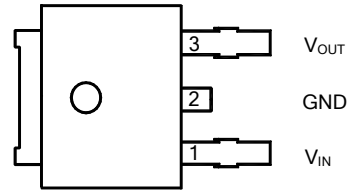
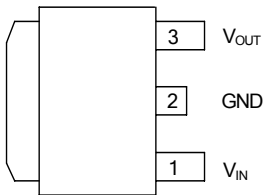

H Package  
(SOT-223)

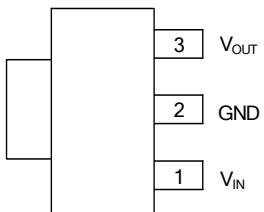

Figure 2. Pin Configuration of AZ2940 (Top View)

**1A ULTRA LOW DROPOUT LINEAR REGULATOR**
**AZ2940**
**Pin Description**

Pin Number	Pin Name	Function
1	$V_{IN}$	Unregulated Input
2	GND	Ground pin. This pin and TAB are internally connected
3	$V_{OUT}$	Regulated Output

**Functional Block Diagram**

Figure 3. Functional Block Diagram of AZ2940



**1A ULTRA LOW DROPOUT LINEAR REGULATOR**

**AZ2940**

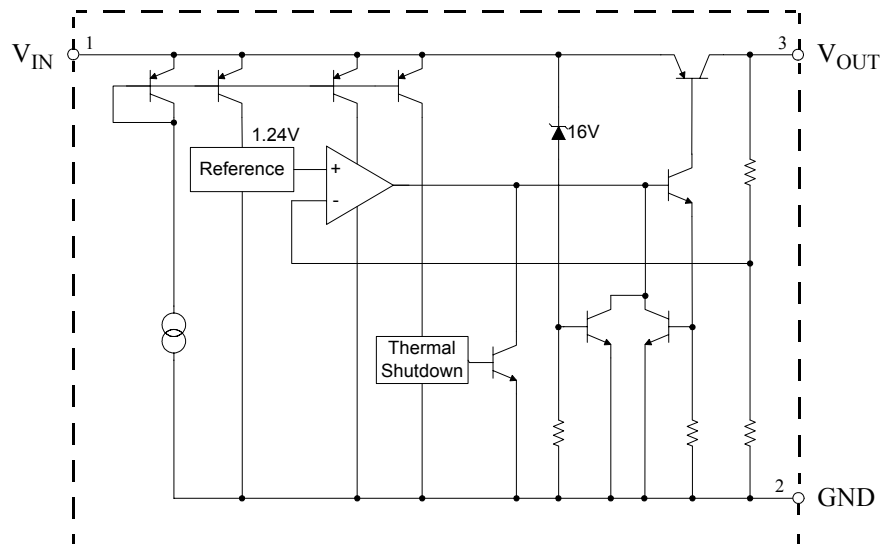
**Ordering Information**

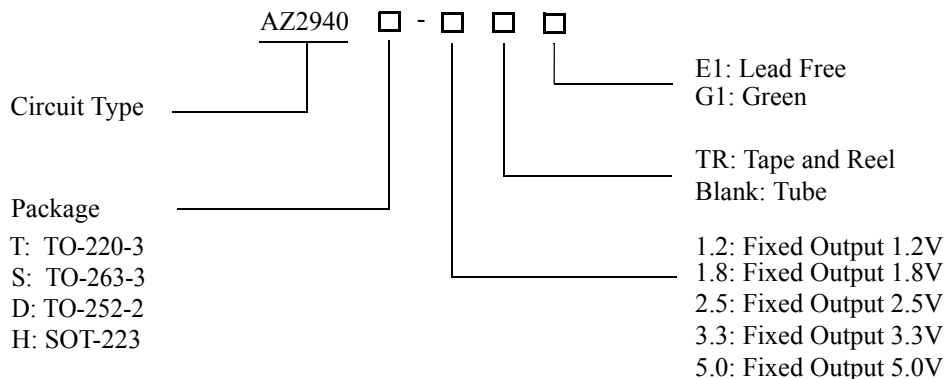

Package	Temperature Range	Part Number		Marking ID		Packing Type
		Lead Free	Green	Lead Free	Green	
TO-220-3	-40 to 125°C	AZ2940T-3.3E1	AZ2940T-3.3G1	AZ2940T-3.3E1	AZ2940T-3.3G1	Tube
		AZ2940T-5.0E1	AZ2940T-5.0G1	AZ2940T-5.0E1	AZ2940T-5.0G1	Tube
TO-263-3	-40 to 125°C	AZ2940S-3.3E1	AZ2940S-3.3G1	AZ2940S-3.3E1	AZ2940S-3.3G1	Tube
		AZ2940S-3.3TRE1	AZ2940S-3.3TRG1	AZ2940S-3.3E1	AZ2940S-3.3G1	Tape & Reel
		AZ2940S-5.0E1	AZ2940S-5.0G1	AZ2940S-5.0E1	AZ2940S-5.0G1	Tube
		AZ2940S-5.0TRE1	AZ2940S-5.0TRG1	AZ2940S-5.0E1	AZ2940S-5.0G1	Tape & Reel
TO-252-2	-40 to 125°C		AZ2940D-1.2G1		AZ2940D-1.2G1	Tube
			AZ2940D-1.2TRG1		AZ2940D-1.2G1	Tape & Reel
		AZ2940D-1.8E1	AZ2940D-1.8G1	AZ2940D-1.8E1	AZ2940D-1.8G1	Tube
		AZ2940D-1.8TRE1	AZ2940D-1.8TRG1	AZ2940D-1.8E1	AZ2940D-1.8G1	Tape & Reel
		AZ2940D-2.5E1	AZ2940D-2.5G1	AZ2940D-2.5E1	AZ2940D-2.5G1	Tube
		AZ2940D-2.5TRE1	AZ2940D-2.5TRG1	AZ2940D-2.5E1	AZ2940D-2.5G1	Tape & Reel
		AZ2940D-3.3E1	AZ2940D-3.3G1	AZ2940D-3.3E1	AZ2940D-3.3G1	Tube
		AZ2940D-3.3TRE1	AZ2940D-3.3TRG1	AZ2940D-3.3E1	AZ2940D-3.3G1	Tape & Reel
		AZ2940D-5.0E1	AZ2940D-5.0G1	AZ2940D-5.0E1	AZ2940D-5.0G1	Tube
AZ2940D-5.0TRE1	AZ2940D-5.0TRG1	AZ2940D-5.0E1	AZ2940D-5.0G1	Tape & Reel		
SOT-223	-40 to 125°C		AZ2940H-1.2TRG1		GH12B	Tape & Reel
			AZ2940H-1.8TRG1		GH12F	Tape & Reel
			AZ2940H-2.5TRG1		GH12G	Tape & Reel
			AZ2940H-3.3TRG1		GH12H	Tape & Reel
			AZ2940H-5.0TRG1		GH12J	Tape & Reel

BCD Semiconductor's Pb-free products, as designated with "E1" suffix in the part number, are RoHS compliant. Products with "G1" suffix are available in green packages.

**1A ULTRA LOW DROPOUT LINEAR REGULATOR****AZ2940****Absolute Maximum Ratings (Note 1)**

Parameter	Symbol	Value		Unit
Input Voltage	$V_{IN}$	16		V
Operating Junction Temperature	$T_J$	150		°C
Storage Temperature Range	$T_{STG}$	-65 to 150		°C
Lead Temperature (Soldering, 10sec)	$T_{LEAD}$	260		°C
Thermal Resistance	$\theta_{JA}$	TO-220-3	60	°C/W
		TO-263-3	60	
		TO-252-2	100	
		SOT-223	120	
ESD (Human Body Model)	ESD	5000		V
ESD (Machine Model)	ESD	300		V

Note 1: Stresses greater than those listed under "Absolute Maximum Ratings" may cause permanent damage to the device. These are stress ratings only, and functional operation of the device at these or any other conditions beyond those indicated under "Recommended Operating Conditions" is not implied. Exposure to "Absolute Maximum Ratings" for extended periods may affect device reliability.

**Recommended Operating Conditions**

Parameter	Symbol	Min	Max	Unit
Input Voltage	$V_{IN}$	2.5	13.2	V
Operating Junction Temperature	$T_J$	-40	125	°C

**1A ULTRA LOW DROPOUT LINEAR REGULATOR****AZ2940****Electrical Characteristics****AZ2940-1.2 Electrical Characteristics**

Operating Conditions:  $V_{IN}=2.5V$ ,  $I_{OUT}=10mA$ ,  $C_{IN}=10\mu F$ ,  $C_{OUT}=10\mu F$ ,  $T_J=25^{\circ}C$ , unless otherwise specified.  
The **Boldface** applies over  $-40^{\circ}C \leq T_J \leq 125^{\circ}C$ .

Parameter	Symbol	Condition	Min	Typ	Max	Unit	
Output Voltage	$V_{OUT}$	$I_{OUT}=10mA$	1.188	1.2	1.212	V	
		$10mA \leq I_{OUT} \leq 1A$ , $2.5V \leq V_{IN} \leq 13.2V$	<b>1.176</b>	<b>1.2</b>	<b>1.224</b>	V	
Line Regulation	$V_{RLINE}$	$I_{OUT}=10mA$ , $2.5V \leq V_{IN} \leq 13.2V$		3.6	18	mV	
Load Regulation	$V_{RLOAD}$	$V_{IN}=2.5V$ , $10mA \leq I_{OUT} \leq 1A$		5.4	27	mV	
Output Voltage Temperature Coefficient	$\Delta V_{OUT}/\Delta T$	$I_{OUT}=10mA$			<b>180</b>	$\mu V/^{\circ}C$	
Ground Current	$I_{GND}$	$V_{IN}=2.5V$	$I_{OUT}=750mA$		12	<b>25</b>	mA
			$I_{OUT}=1A$		18		mA
Short Circuit Current	$I_{SC}$	$V_{OUT}=0V$ (Note 2)	1.5	2.2		A	
Minimum Load Current	$I_{LOAD(MIN)}$			1	5	mA	
Output Noise Voltage (rms)		10Hz to 100KHz, $I_{OUT}=100mA$ , $C_{OUT}=10\mu F$		400		$\mu V$	
Thermal Resistance	$\theta_{JC}$	TO-252-2		7.8		$^{\circ}C/W$	
		SOT-223		29.7			

Note 2:  $V_{IN}=V_{OUT(NOMINAL)}+1V$ .



**1A ULTRA LOW DROPOUT LINEAR REGULATOR** **AZ2940**

**Electrical Characteristics**

**AZ2940-1.8 Electrical Characteristics**

Operating Conditions:  $V_{IN}=2.8V$ ,  $I_{OUT}=10mA$ ,  $C_{IN}=10\mu F$ ,  $C_{OUT}=10\mu F$ ,  $T_J=25^{\circ}C$ , unless otherwise specified. The **Boldface** applies over  $-40^{\circ}C \leq T_J \leq 125^{\circ}C$ .

Parameter	Symbol	Condition	Min	Typ	Max	Unit	
Output Voltage	$V_{OUT}$	$I_{OUT}=10mA$	1.782	1.8	1.818	V	
		$10mA \leq I_{OUT} \leq 1A$ , $2.8V \leq V_{IN} \leq 13.2V$	<b>1.764</b>	<b>1.8</b>	<b>1.836</b>	V	
Line Regulation	$V_{RLINE}$	$I_{OUT}=10mA$ , $2.8V \leq V_{IN} \leq 13.2V$		3.6	18	mV	
Load Regulation	$V_{RLOAD}$	$V_{IN}=2.8V$ , $10mA \leq I_{OUT} \leq 1A$		5.4	27	mV	
Output Voltage Temperature Coefficient	$\Delta V_{OUT}/\Delta T$	$I_{OUT}=10mA$		<b>36</b>	<b>180</b>	$\mu V/^{\circ}C$	
Dropout Voltage (Note 3)	$V_{DROP}$	$\Delta V_{OUT}=1\%$		$I_{OUT}=100mA$	290	<b>500</b>	mV
				$I_{OUT}=1A$	330	<b>750</b>	mV
Ground Current	$I_{GND}$	$V_{IN}=2.8V$	$I_{OUT}=750mA$	12	<b>25</b>	mA	
			$I_{OUT}=1A$	18		mA	
Short Circuit Current	$I_{SC}$	$V_{OUT}=0V$ (Note 2)	1.5	2.2		A	
Minimum Load Current	$I_{LOAD(MIN)}$			1	5	mA	
Output Noise Voltage (rms)		10Hz to 100KHz, $I_{OUT}=100mA$ , $C_{OUT}=10\mu F$		400		$\mu V$	
Thermal Resistance	$\theta_{JC}$	TO-252-2		7.8		$^{\circ}C/W$	
		SOT-223		29.7			

Note 2:  $V_{IN}=V_{OUT(NOMINAL)}+1V$ .

Note 3: Dropout voltage is defined as the input-to-output differential when the output voltage drops to 99% of its nominal value which is measured at  $V_{OUT}+1V$  applied to  $V_{IN}$ . In application,  $V_{IN}$  should be no less than 2.5V.

**1A ULTRA LOW DROPOUT LINEAR REGULATOR****AZ2940****Electrical Characteristics (Continued)****AZ2940-2.5 Electrical Characteristics**

Operating Conditions:  $V_{IN}=3.5V$ ,  $I_{OUT}=10mA$ ,  $C_{IN}=10\mu F$ ,  $C_{OUT}=10\mu F$ ,  $T_J=25^\circ C$ , unless otherwise specified.

The **Boldface** applies over  $-40^\circ C \leq T_J \leq 125^\circ C$ .

Parameter	Symbol	Condition	Min	Typ	Max	Unit	
Output Voltage	$V_{OUT}$	$I_{OUT}=10mA$	2.475	2.5	2.525	V	
		$10mA \leq I_{OUT} \leq 1A$ , $3.5V \leq V_{IN} \leq 13.2V$	<b>2.45</b>	<b>2.5</b>	<b>2.55</b>	V	
Line Regulation	$V_{RLINE}$	$I_{OUT}=10mA$ , $3.5V \leq V_{IN} \leq 13.2V$		5.0	25	mV	
Load Regulation	$V_{RLOAD}$	$V_{IN}=3.5V$ , $10mA \leq I_{OUT} \leq 1A$		7.5	37.5	mV	
Output Voltage Temperature Coefficient	$\Delta V_{OUT}/\Delta T$	$I_{OUT}=10mA$		<b>50</b>	<b>250</b>	$\mu V/^\circ C$	
Dropout Voltage (Note 4)	$V_{DROP}$	$\Delta V_{OUT}=1\%$	$I_{OUT}=100mA$		70	<b>200</b>	mV
			$I_{OUT}=1A$		280	<b>550</b>	mV
Ground Current	$I_{GND}$	$V_{IN}=3.5V$	$I_{OUT}=750mA$		12	<b>25</b>	mA
			$I_{OUT}=1A$		18		mA
Short Circuit Current	$I_{SC}$	$V_{OUT}=0V$ (Note 2)	1.5	2.2		A	
Minimum Load Current	$I_{LOAD(MIN)}$			1	5	mA	
Output Noise Voltage (rms)		10Hz to 100KHz, $I_{OUT}=100mA$ , $C_{OUT}=10\mu F$		400		$\mu V$	
Thermal Resistance	$\theta_{JC}$	TO-252-2		7.8		$^\circ C/W$	
		SOT-223		29.7			

Note 2:  $V_{IN}=V_{OUT(NOMINAL)}+1V$ .

Note 4: Dropout voltage is defined as the input-to-output differential when the output voltage drops to 99% of its nominal value which is measured at  $V_{OUT}+1V$  applied to  $V_{IN}$ .





**1A ULTRA LOW DROPOUT LINEAR REGULATOR** **AZ2940**

**Electrical Characteristics (Continued)**

**AZ2940-3.3 Electrical Characteristics**

Operating Conditions:  $V_{IN}=4.3V$ ,  $I_{OUT}=10mA$ ,  $C_{IN}=10\mu F$ ,  $C_{OUT}=10\mu F$ ,  $T_J=25^\circ C$ , unless otherwise specified. The **Boldface** applies over  $-40^\circ C \leq T_J \leq 125^\circ C$ .

Parameter	Symbol	Condition	Min	Typ	Max	Unit	
Output Voltage	$V_{OUT}$	$I_{OUT}=10mA$	3.27	3.3	3.33	V	
		$10mA \leq I_{OUT} \leq 1A$ , $4.3V \leq V_{IN} \leq 13.2V$	<b>3.23</b>	<b>3.3</b>	<b>3.37</b>	V	
Line Regulation	$V_{RLINE}$	$I_{OUT}=10mA$ , $4.3V \leq V_{IN} \leq 13.2V$		6.6	33	mV	
Load Regulation	$V_{RLOAD}$	$V_{IN}=4.3V$ , $10mA \leq I_{OUT} \leq 1A$		9.9	50	mV	
Output Voltage Temperature Coefficient	$\Delta V_{OUT}/\Delta T$	$I_{OUT}=10mA$		<b>66</b>	<b>330</b>	$\mu V/^\circ C$	
Dropout Voltage (Note 4)	$V_{DROP}$	$\Delta V_{OUT}=1\%$	$I_{OUT}=100mA$		70	<b>200</b>	mV
			$I_{OUT}=1A$		280	<b>550</b>	mV
Ground Current	$I_{GND}$	$V_{IN}=4.3V$	$I_{OUT}=750mA$		12	<b>25</b>	mA
			$I_{OUT}=1A$		18		mA
Short Circuit Current	$I_{SC}$	$V_{OUT}=0V$ (Note 2)	1.5	2.2		A	
Minimum Load Current	$I_{LOAD(MIN)}$			1	5	mA	
Output Noise Voltage (rms)		10Hz to 100KHz, $I_{OUT}=100mA$ , $C_{OUT}=10\mu F$		400		$\mu V$	
Thermal Resistance	$\theta_{JC}$	TO-220-3		4.4		$^\circ C/W$	
		TO-263-3		4.4			
		TO-252-2		7.8			
		SOT-223		29.7			

Note 2:  $V_{IN}=V_{OUT(NOMINAL)}+1V$ .

Note 4: Dropout voltage is defined as the input-to-output differential when the output voltage drops to 99% of its nominal value which is measured at  $V_{OUT}+1V$  applied to  $V_{IN}$ .



**1A ULTRA LOW DROPOUT LINEAR REGULATOR**

**AZ2940**

**Electrical Characteristics (Continued)**

**AZ2940-5.0 Electrical Characteristics**

Operating Conditions:  $V_{IN}=6V$ ,  $I_{OUT}=10mA$ ,  $C_{IN}=10\mu F$ ,  $C_{OUT}=10\mu F$ ,  $T_J=25^\circ C$ , unless otherwise specified. The **Boldface** applies over  $-40^\circ C \leq T_J \leq 125^\circ C$ .

Parameter	Symbol	Condition	Min	Typ	Max	Unit	
Output Voltage	$V_{OUT}$	$I_{OUT}=10mA$	4.95	5.0	5.05	V	
		$10mA \leq I_{OUT} \leq 1A$ , $6V \leq V_{IN} \leq 13.2V$	<b>4.90</b>	<b>5.0</b>	<b>5.10</b>	V	
Line Regulation	$V_{RLINE}$	$I_{OUT}=10mA$ , $6V \leq V_{IN} \leq 13.2V$		10	50	mV	
Load Regulation	$V_{RLOAD}$	$V_{IN}=6V$ , $10mA \leq I_{OUT} \leq 1A$		15	75	mV	
Output Voltage Temperature Coefficient	$\Delta V_{OUT}/\Delta T$	$I_{OUT}=10mA$		<b>100</b>	<b>500</b>	$\mu V/^\circ C$	
Dropout Voltage (Note 4)	$V_{DROP}$	$\Delta V_{OUT}=1\%$	$I_{OUT}=100mA$		70	<b>200</b>	mV
			$I_{OUT}=1A$		280	<b>550</b>	mV
Ground Current	$I_{GND}$	$V_{IN}=6V$	$I_{OUT}=750mA$		12	<b>25</b>	mA
			$I_{OUT}=1A$		18		mA
Short Circuit Current	$I_{SC}$	$V_{OUT}=0V$ (Note 3)	1.5	2.2		A	
Minimum Load Current	$I_{LOAD(MIN)}$			1	5	mA	
Output Noise Voltage (rms)		10Hz to 100KHz, $I_{OUT}=100mA$ , $C_{OUT}=10\mu F$		400		$\mu V$	
Thermal Resistance	$\theta_{JC}$	TO-220-3		4.4		$^\circ C/W$	
		TO-263-3		4.4			
		TO-252-2		7.8			
		SOT-223		29.7			

Note 2:  $V_{IN}=V_{OUT(NOMINAL)}+1V$ .

Note 4: Dropout voltage is defined as the input-to-output differential when the output voltage drops to 99% of its nominal value which is measured at  $V_{OUT}+1V$  applied to  $V_{IN}$ .



1A ULTRA LOW DROPOUT LINEAR REGULATOR

AZ2940

Typical Performance Characteristics

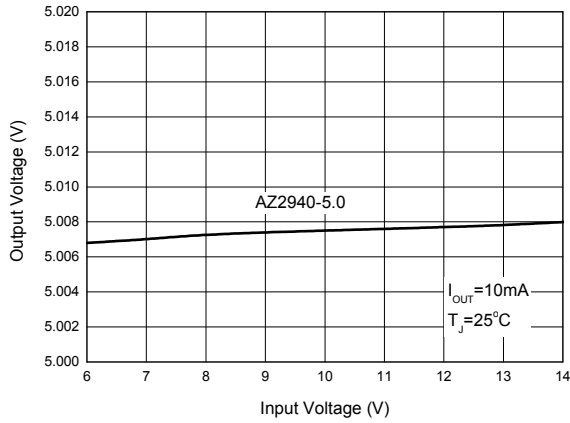

Figure 4. Line Regulation

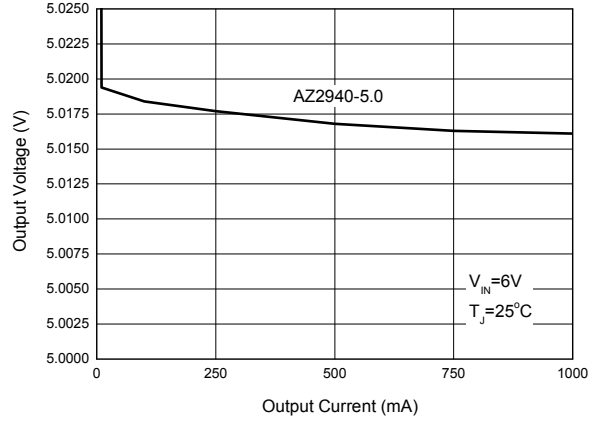

Figure 5. Load Regulation

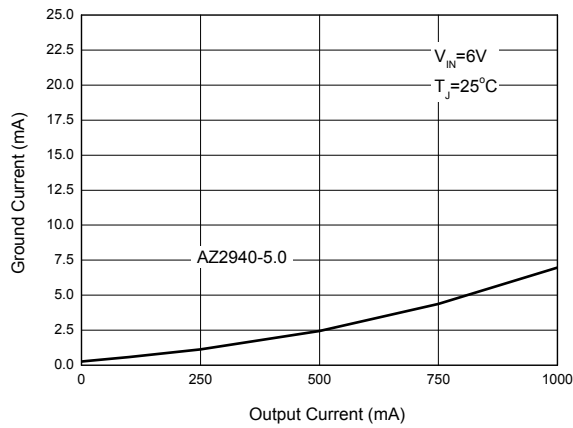

Figure 6. Ground Current vs. Output Current

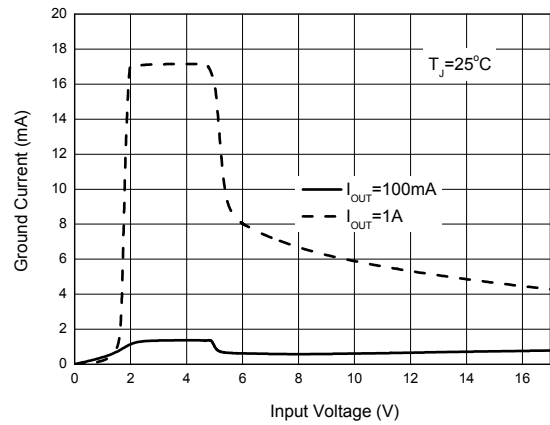

Figure 7. Ground Current vs. Input Voltage



1A ULTRA LOW DROPOUT LINEAR REGULATOR

AZ2940

Typical Performance Characteristics (Continued)

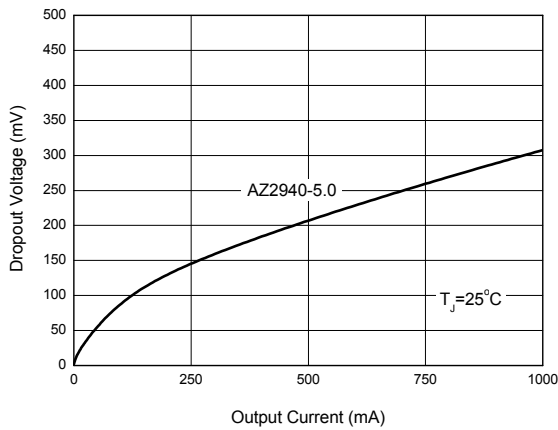

Figure 8. Dropout Voltage vs. Output Current

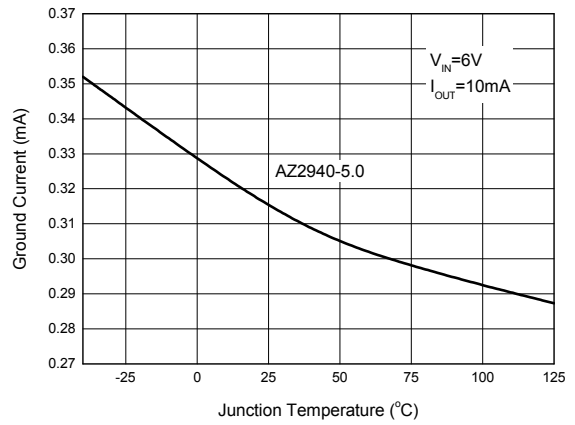

Figure 9. Ground Current vs. Junction Temperature

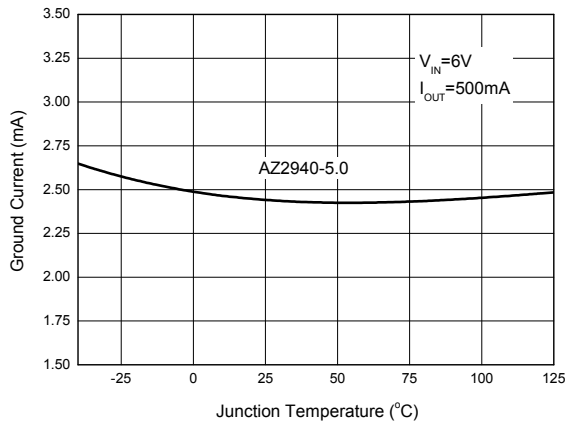

Figure 10. Ground Current vs. Junction Temperature

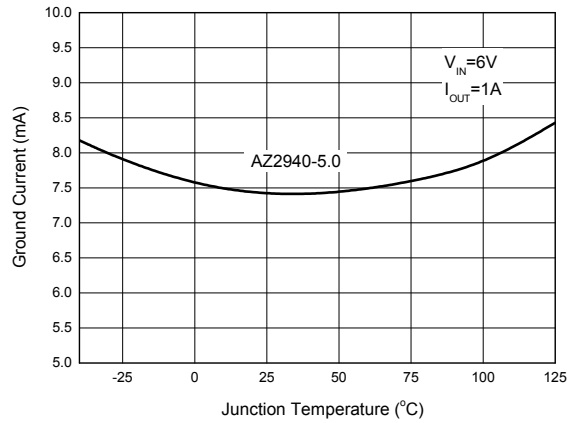

Figure 11. Ground Current vs. Junction Temperature



1A ULTRA LOW DROPOUT LINEAR REGULATOR

AZ2940

Typical Performance Characteristics (Continued)

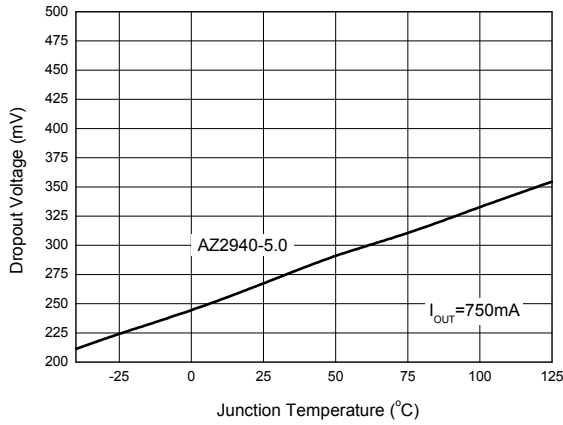

Figure 12. Dropout Voltage vs. Junction Temperature

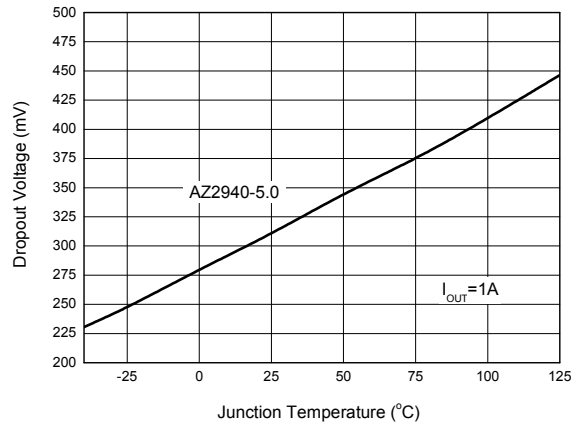

Figure 13. Dropout Voltage vs. Junction Temperature

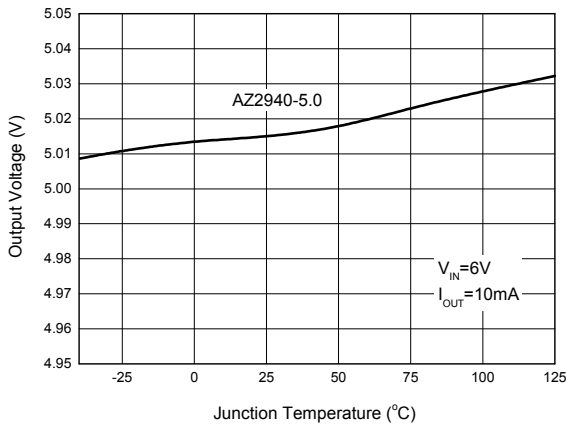

Figure 14. Output Voltage vs. Junction Temperature

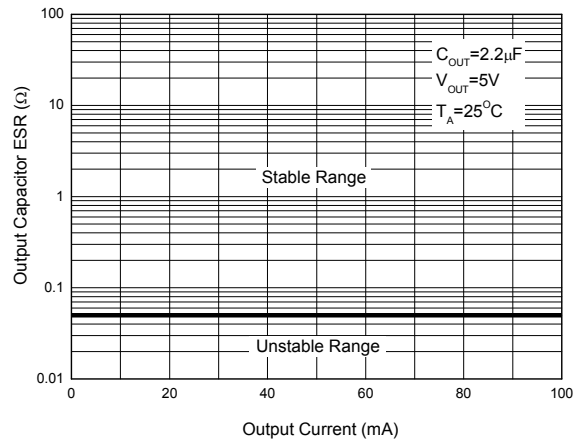

Figure 15. Output Capacitor ESR vs. Output Current



1A ULTRA LOW DROPOUT LINEAR REGULATOR

AZ2940

Typical Performance Characteristics (Continued)

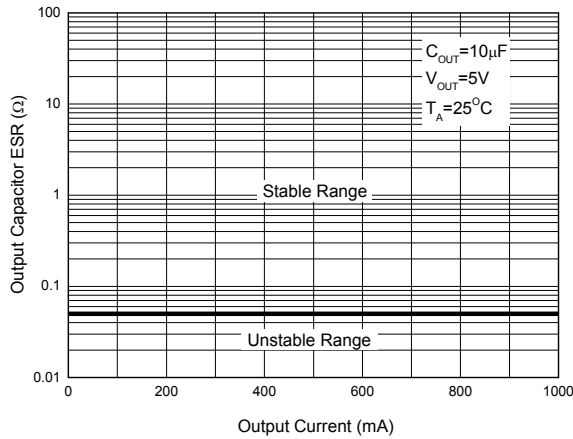

Figure 16. Output Capacitor ESR vs. Output Current

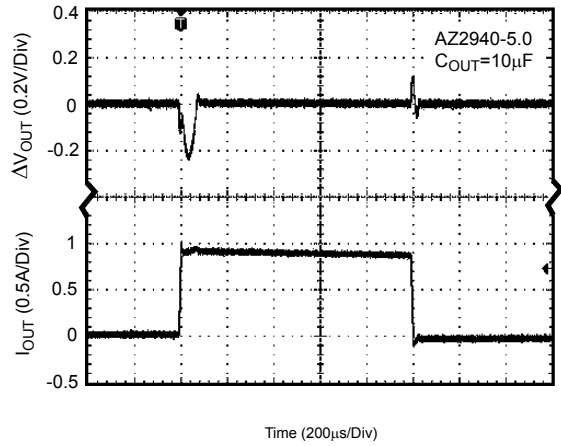

Figure 17. Load Transient

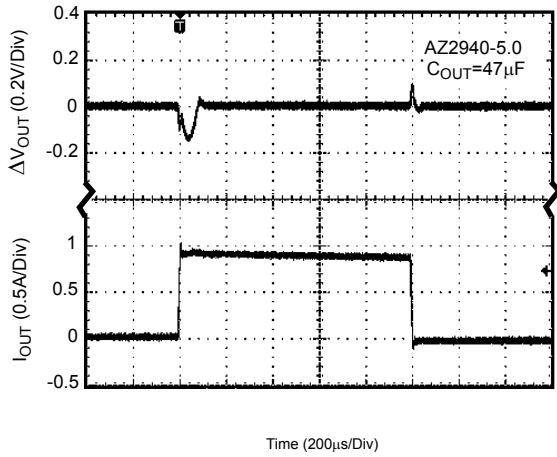

Figure 18. Load Transient

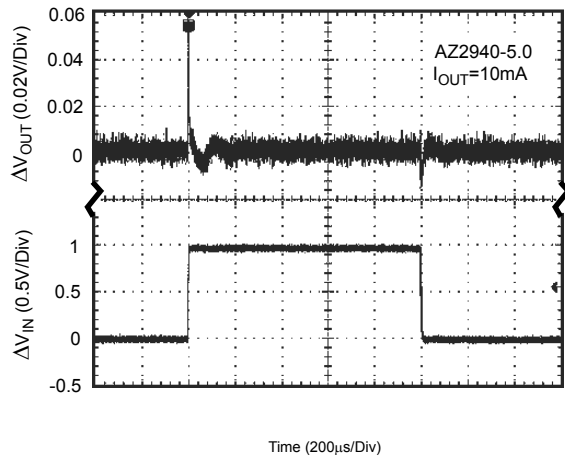

Figure 19. Line Transient



**1A ULTRA LOW DROPOUT LINEAR REGULATOR**

**AZ2940**

**Typical Performance Characteristics (Continued)**

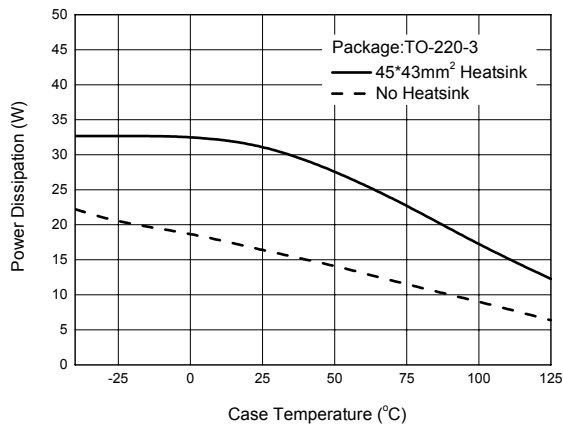

Figure 20. Power Dissipation vs. Case Temperature

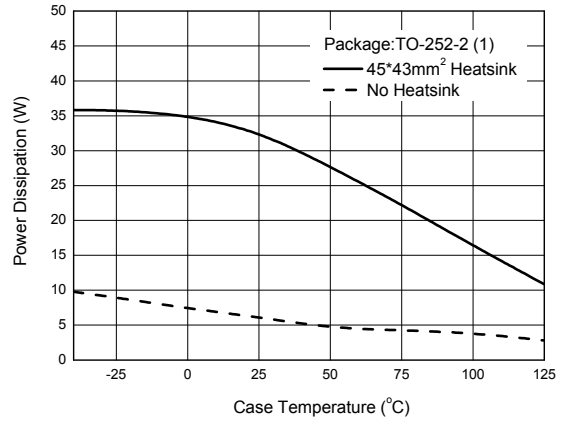

Figure 21. Power Dissipation vs. Case Temperature

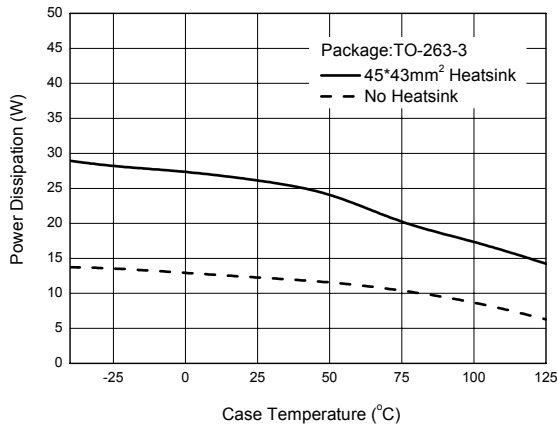

Figure 22. Power Dissipation vs. Case Temperature

**1A ULTRA LOW DROPOUT LINEAR REGULATOR**
**AZ2940**
**Typical Application**

Figure 23. Typical Application of AZ2940

Note:  $C_{IN}$  is required if regulator is located far from power supply filter and is recommended to be  $0.47\mu\text{F}$  or greater. To maintain stability,  $C_{OUT}$  is recommended to be  $2.2\mu\text{F}$  or greater. The ESR of this capacitor is critical, please see curve.



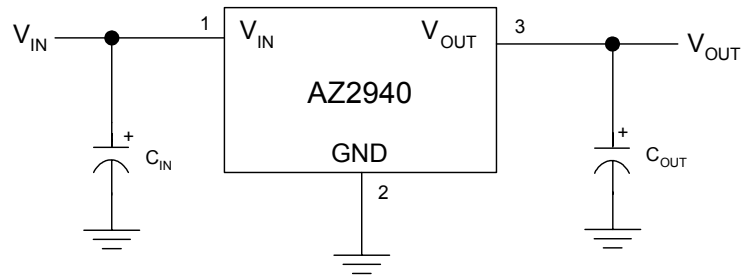

**1A ULTRA LOW DROPOUT LINEAR REGULATOR**

**AZ2940**

**Mechanical Dimensions**

**TO-220-3**

**Unit: mm(inch)**

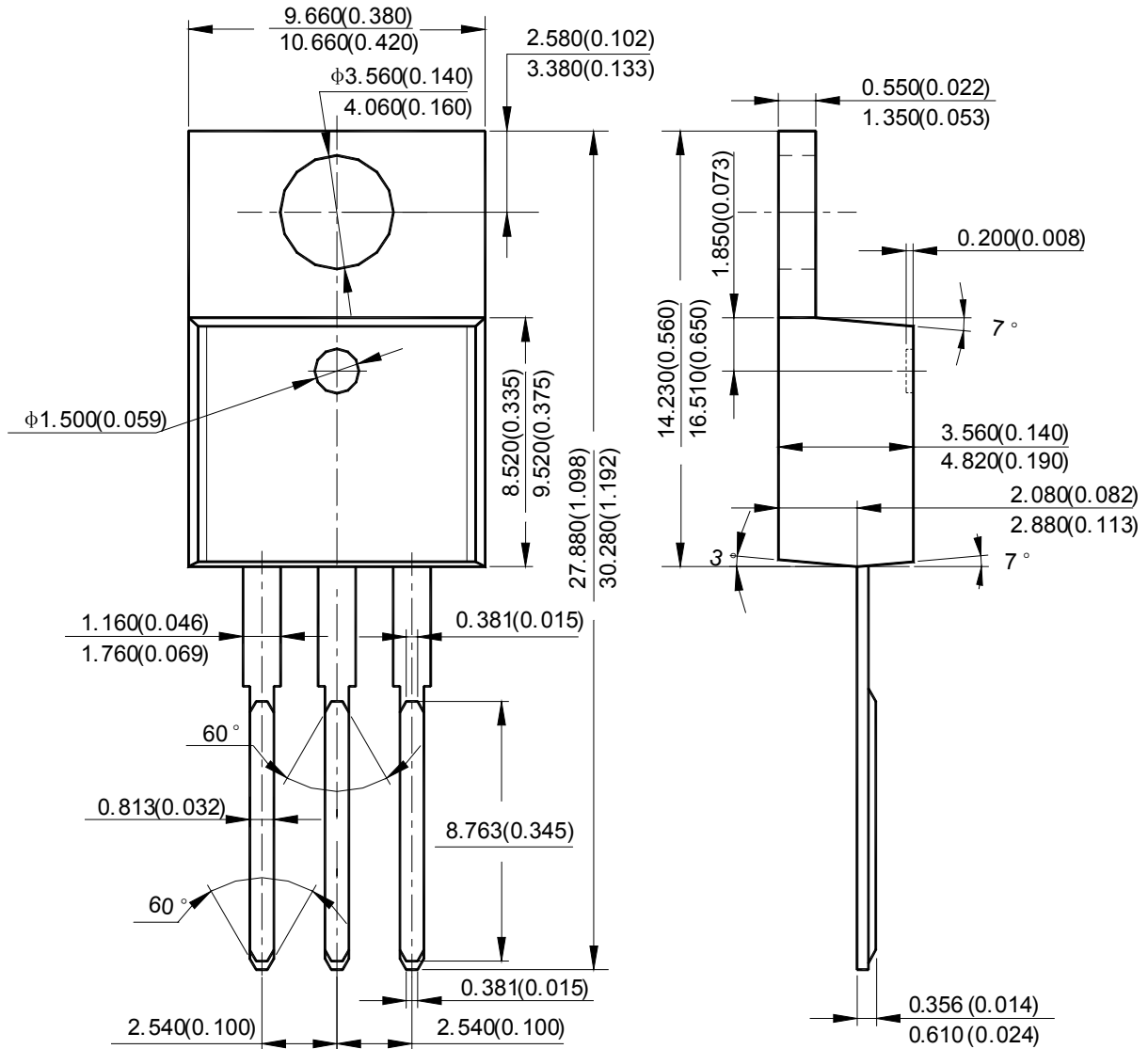



**1A ULTRA LOW DROPOUT LINEAR REGULATOR**

**AZ2940**

**Mechanical Dimensions (Continued)**

**TO-263-3**

**Unit: mm(inch)**

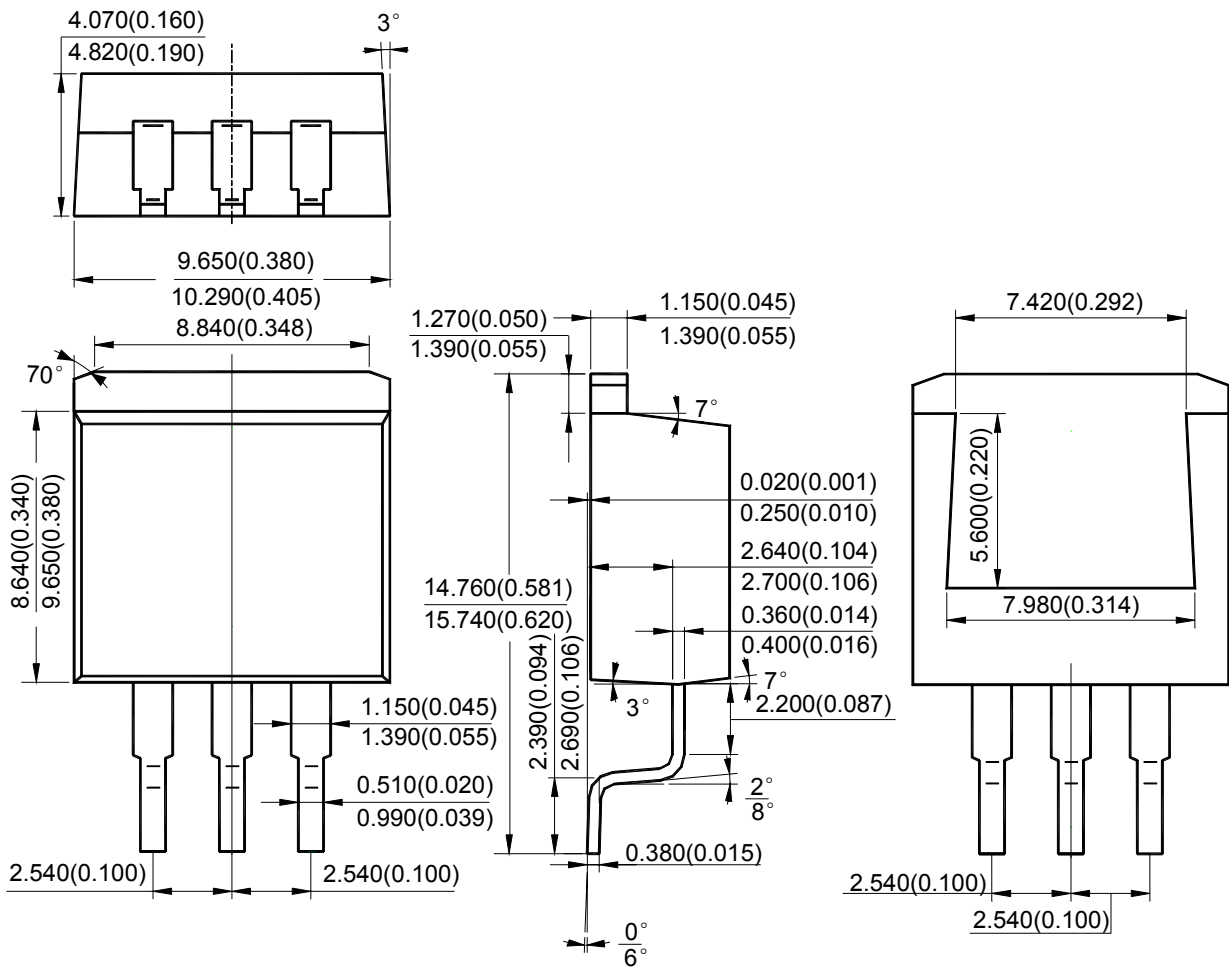



**1A ULTRA LOW DROPOUT LINEAR REGULATOR**

**AZ2940**

**Mechanical Dimensions (Continued)**

**SOT-223**

**Unit: mm(inch)**

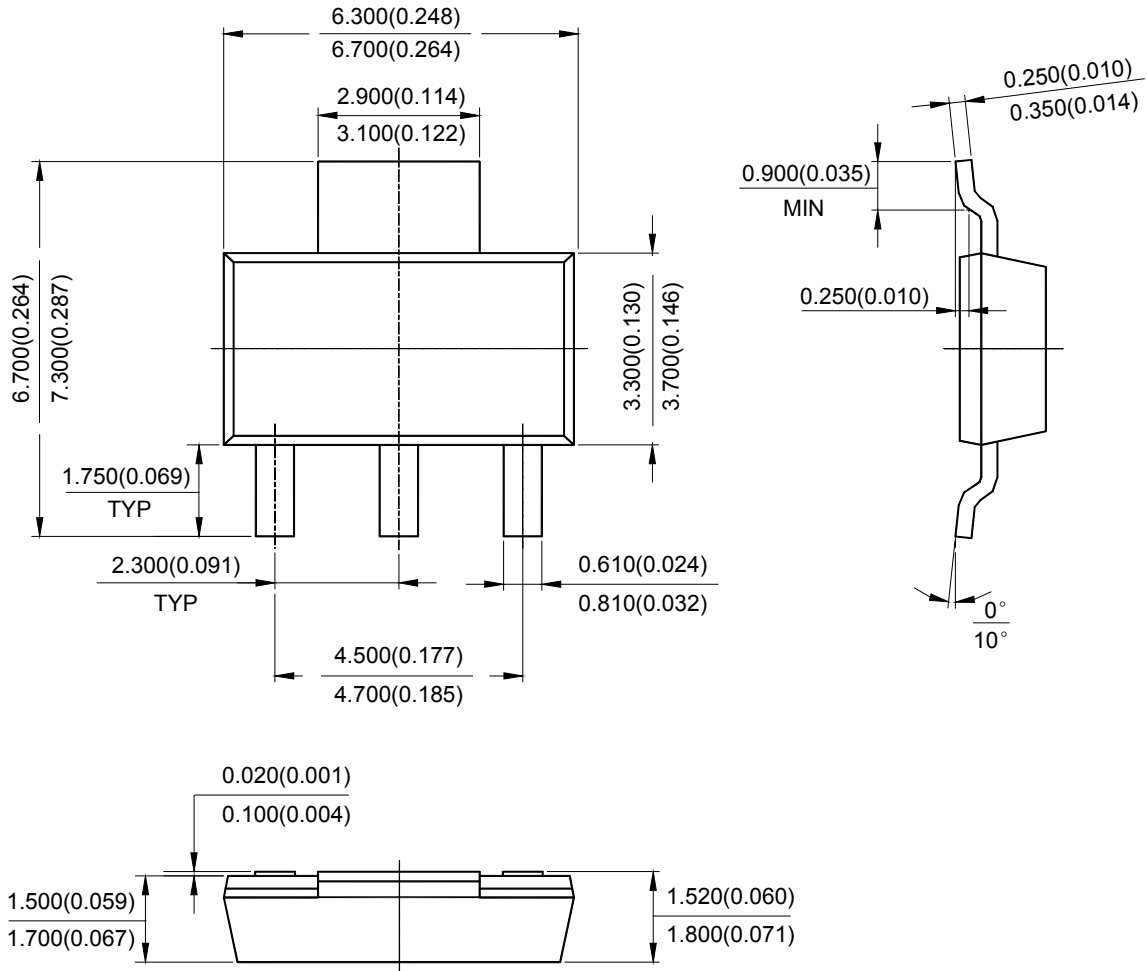



**1A ULTRA LOW DROPOUT LINEAR REGULATOR**

**AZ2940**

**Mechanical Dimensions (Continued)**

**TO-252-2**

**Unit: mm(inch)**

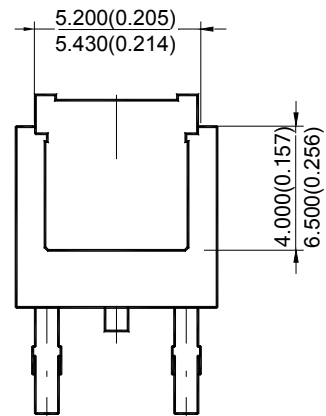
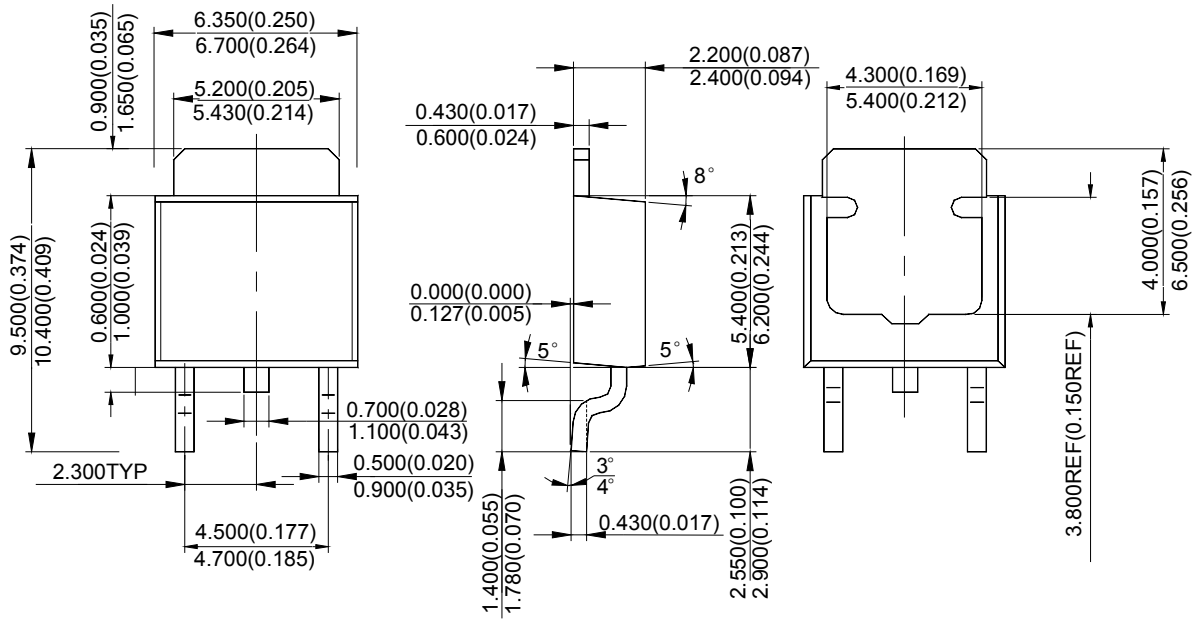

OPTIONAL  
CONSTRUCTION



## **BCD Semiconductor Manufacturing Limited**

<http://www.bcdsemi.com>

### **IMPORTANT NOTICE**

BCD Semiconductor Manufacturing Limited reserves the right to make changes without further notice to any products or specifications herein. BCD Semiconductor Manufacturing Limited does not assume any responsibility for use of any its products for any particular purpose, nor does BCD Semiconductor Manufacturing Limited assume any liability arising out of the application or use of any its products or circuits. BCD Semiconductor Manufacturing Limited does not convey any license under its patent rights or other rights nor the rights of others.

---

#### **MAIN SITE**

##### **- Headquarters**

##### **BCD Semiconductor Manufacturing Limited**

No. 1600, Zi Xing Road, Shanghai Zizhu Science-based Industrial Park, 200241, China  
Tel: +86-21-24162266, Fax: +86-21-24162277

##### **- Wafer Fab**

##### **Shanghai SIM-BCD Semiconductor Manufacturing Co., Ltd.**

800 Yi Shan Road, Shanghai 200233, China  
Tel: +86-21-6485 1491, Fax: +86-21-5450 0008

#### **REGIONAL SALES OFFICE**

##### **Shenzhen Office**

##### **Shanghai SIM-BCD Semiconductor Manufacturing Co., Ltd., Shenzhen Office**

Unit A Room 1203, Skyworth Bldg., Gaoxin Ave. 1.S., Nanshan District, Shenzhen, China  
Tel: +86-755-8826 7951  
Fax: +86-755-8826 7865

##### **Taiwan Office**

##### **BCD Semiconductor (Taiwan) Company Limited**

4F, 298-1, Rui Guang Road, Nei-Hu District, Taipei, Taiwan  
Tel: +886-2-2656 2808  
Fax: +886-2-2656 2806

##### **USA Office**

##### **BCD Semiconductor Corp.**

30920 Huntwood Ave. Hayward, CA 94544, USA  
Tel : +1-510-324-2988  
Fax: +1-510-324-2788