

LSG T670, LSP T670, LSY T670, LOP T670, LYG T670



Besondere Merkmale

- **Gehäusetyp:** weißes P-LCC-4 Gehäuse
- **Besonderheit des Bauteils:** beide Leuchtdiodenchips getrennt ansteuerbar, hohe Signalwirkung durch Farbwechsel der LED möglich
- **Wellenlänge:** 628 nm (super-rot), 606 nm (orange), 590 nm (gelb), 570 nm (grün), 560 nm (pure green)
- **Abstrahlwinkel:** Lambertscher Strahler (120°)
- **Technologie:** GaAIP (super-rot, orange, gelb, grün), GaP (pure green)
- **optischer Wirkungsgrad:** 1,5 lm/W (super-rot, orange, gelb), 2,5 lm/W (grün), 0,6 lm/W (pure green)
- **Gruppierungsparameter:** Lichtstärke
- **Verarbeitungsmethode:** für alle SMT-Bestücktechniken geeignet
- **Lötmethode:** IR Reflow Löten und Wellenlöten (TTW)
- **Vorbehandlung:** nach JEDEC Level 2
- **Gurtung:** 8 mm Gurt mit 2000/Rolle, ø180 mm oder 8000/Rolle, ø330 mm

Anwendungen

- Informationsanzeigen im Innen- und Außenbereich
- optischer Indikator
- Hinterleuchtung (Schalter, Tasten, Displays, Werbebeleuchtung, Allgemeinbeleuchtung)
- Innenbeleuchtung im Automobilbereich (z. B. Instrumentenbeleuchtung)
- Markierungsbeleuchtung (z.B. Stufen, Fluchtwege, u.ä.)
- Einkopplung in Lichtleiter
- Laufschriftanzeigen
- Signal- und Symbolleuchten

Features

- **package:** white P-LCC-4 package
- **feature of the device:** both chips can be controlled separately, high signal efficiency possible by color change of the LED
- **wavelength:** 628 nm (super-red), 606 nm (orange), 590 nm (yellow), 570 nm (green), 560 nm (pure green)
- **viewing angle:** Lambertian Emitter (120°)
- **technology:** GaAIP (super-red, orange, yellow, green), GaP (pure green)
- **optical efficiency:** 1.5 lm/W (super-red, orange, yellow), 2.5 lm/W (green), 0.6 lm/W (pure green)
- **grouping parameter:** luminous intensity
- **assembly methods:** suitable for all SMT assembly methods
- **soldering methods:** IR reflow soldering and TTW soldering
- **preconditioning:** acc. to JEDEC Level 2
- **taping:** 8 mm tape with 2000/reel, ø180 mm or 8000/reel, ø330 mm

Applications

- indoor and outdoor displays
- optical indicators
- backlighting (switches, keys, displays, illuminated advertising, general lighting)
- interior automotive lighting (e.g. dashboard backlighting)
- marker lights (e.g. steps, exit ways, etc.)
- coupling into light guides
- light writing displays
- signal and symbol luminaire

LSG T670, LSP T670, LSY T670, LOP T670, LYG T670

Typ	Emissions- farbe	Farbe der Lichtaustritts- fläche	Lichtstärke		Bestellnummer
Type	Color of Emission	Color of the Light Emitting Area	Luminous Intensity $I_F = 10 \text{ mA}$ $I_V \text{ (mcd)}$		Ordering Code
			color 1	color 2	
LSG T670 LSG T670-J+J LSG T670-J+K LSG T670-J+L LSG T670-K+J LSG T670-K+K LSG T670-K+L LSG T670-L+J LSG T670-L+K LSG T670-L+L	super-red / green	colorless clear	4.5 ... 18.0 4.5 ... 7.1 4.5 ... 7.1 4.5 ... 7.1 7.1 ... 11.2 7.1 ... 11.2 7.1 ... 11.2 11.2 ... 18.0 11.2 ... 18.0 11.2 ... 18.0	4.5 ... 18.0 4.5 ... 7.1 7.1 ... 11.2 11.2 ... 18.0 4.5 ... 7.1 7.1 ... 11.2 11.2 ... 18.0 4.5 ... 7.1 7.1 ... 11.2 11.2 ... 18.0	Q62703Q4316
LSP T670 LSP T670-H+G LSP T670-H+H LSP T670-J+G LSP T670-J+H LSP T670-J+J LSP T670-K+G LSP T670-K+H LSP T670-K+J	super-red / pure green	colorless clear	2.8 ... 11.2 2.8 ... 4.5 2.8 ... 4.5 4.5 ... 7.1 4.5 ... 7.1 4.5 ... 7.1 7.1 ... 11.2 7.1 ... 11.2 7.1 ... 11.2	1.8 ... 7.1 1.8 ... 2.8 2.8 ... 4.5 1.8 ... 2.8 2.8 ... 4.5 4.5 ... 7.1 1.8 ... 2.8 2.8 ... 4.5 4.5 ... 7.1	Q62703Q4318
LSY T670 LSY T670-J+J LSY T670-J+K LSY T670-J+L LSY T670-K+J LSY T670-K+K LSY T670-K+L LSY T670-L+J LSY T670-L+K LSY T670-L+L	super-red / yellow	colorless clear	4.5 ... 18.0 4.5 ... 7.1 4.5 ... 7.1 4.5 ... 7.1 7.1 ... 11.2 7.1 ... 11.2 7.1 ... 11.2 11.2 ... 18.0 11.2 ... 18.0 11.2 ... 18.0	4.5 ... 18.0 4.5 ... 7.1 7.1 ... 11.2 11.2 ... 18.0 4.5 ... 7.1 7.1 ... 11.2 11.2 ... 18.0 4.5 ... 7.1 7.1 ... 11.2 11.2 ... 18.0	Q62703Q4317

LSG T670, LSP T670, LSY T670, LOP T670, LYG T670

Type	Emissionsfarbe	Farbe der Lichtaustrittsfläche	Lichtstärke		Bestellnummer
Type	Color of Emission	Color of the Light Emitting Area	Luminous Intensity $I_F = 10 \text{ mA}$ $I_V \text{ (mcd)}$		Ordering Code
			color 1	color 2	
LOP T670	orange / pure green	colorless clear	4.5 ... 11.2	1.8 ... 7.1	Q62703Q4319
LOP T670-J+G			4.5 ... 7.1	1.8 ... 2.8	
LOP T670-J+H			4.5 ... 7.1	2.8 ... 4.5	
LOP T670-J+J			4.5 ... 7.1	4.5 ... 7.1	
LOP T670-K+G			7.1 ... 11.2	1.8 ... 2.8	
LOP T670-K+H			7.1 ... 11.2	2.8 ... 4.5	
LOP T670-K+J			7.1 ... 11.2	4.5 ... 7.1	
LYG T670			yellow / green	colorless clear	
LYG T670-J+J	4.5 ... 7.1	4.5 ... 7.1			
LYG T670-J+K	4.5 ... 7.1	7.1 ... 11.2			
LYG T670-J+L	4.5 ... 7.1	11.2 ... 18.0			
LYG T670-K+J	7.1 ... 11.2	4.5 ... 7.1			
LYG T670-K+K	7.1 ... 11.2	7.1 ... 11.2			
LYG T670-K+L	7.1 ... 11.2	11.2 ... 18.0			
LYG T670-L+J	11.2 ... 18.0	4.5 ... 7.1			
LYG T670-L+K	11.2 ... 18.0	7.1 ... 11.2			
LYG T670-L+L	11.2 ... 18.0	11.2 ... 18.0			

Helligkeitswerte werden mit einer Stromeinprägedauer von 25 ms und einer Genauigkeit von $\pm 11 \%$ ermittelt.
Luminous intensity is tested at a current pulse duration of 25 ms and a tolerance of $\pm 11 \%$.

Anm.: Die Standardlieferform von Serientypen beinhaltet eine Familiengruppe. Einzelne Gruppen sind nicht erhältlich.

In einer Verpackungseinheit / Gurt ist immer nur eine Gruppe pro Farbe enthalten.

Streuung der Lichtstärke in einer Verpackungseinheit $I_{V \max} / I_{V \min} \leq 2.0$

*Streuung der Lichtstärke in einer LED $I_{V \max} / I_{V \min} \leq 3.0$ (LSG T670, LSY T670),
 ≤ 4.0 (LSP T670, LOP T670)*

Note: The standard shipping format for serial types includes a family group. Individual groups are not available.

No packing unit / tape ever contains more than one luminous intensity group per color.

Luminous intensity ratio in one packaging unit $I_{V \max} / I_{V \min} \leq 2.0$

*Luminous intensity ratio in one LED $I_{V \max} / I_{V \min} \leq 3.0$ (LSG T670, LSY T670),
 ≤ 4.0 (LSP T670, LOP T670)*

Grenzwerte
Maximum Ratings

Bezeichnung Parameter	Symbol Symbol	Wert Value		Einheit Unit
		LS, LO, LY, LG	LP	
Betriebstemperatur Operating temperature range	T_{op}	- 40 ... + 100		°C
Lagertemperatur Storage temperature range	T_{stg}	- 40 ... + 100		°C
Sperrschichttemperatur Junction temperature	T_j	+ 100		°C
Durchlassstrom Forward current	I_F	30		mA
Stoßstrom Surge current $t \leq 10 \mu s, D = 0.005$	I_{FM}	0.5		A
Sperrspannung ¹⁾ Reverse voltage	V_R	12		V
Leistungsaufnahme Power consumption	P_{tot}	95	90	mW
Wärmewiderstand Thermal resistance				
Sperrschicht / Umgebung Junction / air	1 chip on $R_{th JA}$	480		K/W
	2 chips on $R_{th JA}$	650		K/W
Sperrschicht / Löt看 Junction / solder point	1 chip on $R_{th JS}$	260		K/W
	2 chips on $R_{th JS}$	430		K/W
Montage auf PC-Board FR 4 (Padgröße $\geq 16 \text{ mm}^2$) mounted on PC board FR 4 (pad size $\geq 16 \text{ mm}^2$)				

¹⁾ für kurzzeitigen Betrieb geeignet / suitable for short term application

LSG T670, LSP T670, LSY T670, LOP T670, LYG T670

Bezeichnung ($T_A = 25\text{ °C}$) Parameter	Symbol Symbol	Wert Value					Einheit Unit
		LS	LO	LY	LG	LP	
Wellenlänge des emittierten Lichtes (typ.) Wavelength at peak emission $I_F = 10\text{ mA}$	λ_{peak}	635	610	586	572	557	nm
Dominantwellenlänge ¹⁾ (typ.) Dominant wavelength ¹⁾ $I_F = 10\text{ mA}$	λ_{dom}	628 ± 6	606 ± 6	590 ± 6	570 ± 6	560 ± 6	nm
Spektrale Bandbreite bei 50 % $I_{\text{rel max}}$ (typ.) Spectral bandwidth at 50 % $I_{\text{rel max}}$ $I_F = 10\text{ mA}$	$\Delta\lambda$	45	40	45	25	22	nm
Abstrahlwinkel bei 50 % I_V (Vollwinkel) (typ.) Viewing angle at 50 % I_V	2ϕ	120	120	120	120	120	Grad deg.
Durchlassspannung ²⁾ (typ.) Forward voltage ²⁾ (max.) $I_F = 10\text{ mA}$	V_F V_F	2.0 2.5	2.0 2.5	2.0 2.5	2.0 2.5	2.0 2.5	V V
Sperrstrom (typ.) Reverse current (max.) $V_R = 12\text{ V}$	I_R I_R	0.01 10	0.01 10	0.01 10	0.01 10	0.01 10	μA μA
Temperaturkoeffizient von λ_{peak} (typ.) Temperature coefficient of λ_{peak} $I_F = 10\text{ mA}; -10\text{ °C} \leq T \leq 100\text{ °C}$	$TC_{\lambda_{\text{peak}}}$	0.11	0.12	0.10	0.11	0.11	nm/K
Temperaturkoeffizient von λ_{dom} (typ.) Temperature coefficient of λ_{dom} $I_F = 10\text{ mA}; -10\text{ °C} \leq T \leq 100\text{ °C}$	$TC_{\lambda_{\text{dom}}}$	0.07	0.07	0.07	0.07	0.05	nm/K
Temperaturkoeffizient von V_F (typ.) Temperature coefficient of V_F $I_F = 10\text{ mA}; -10\text{ °C} \leq T \leq 100\text{ °C}$	TC_V	-1.9	-1.9	-1.9	-1.4	-2.1	mV/K
Optischer Wirkungsgrad (typ.) Optical efficiency $I_F = 10\text{ mA}$	η_{opt}	1.5	1.5	1.5	2.5	0.6	lm/W

¹⁾ Wellenlängen werden mit einer Stromeinprägedauer von 25 ms und einer Genauigkeit von $\pm 1\text{ nm}$ ermittelt.
Wavelengths are tested at a current pulse duration of 25 ms and a tolerance of $\pm 1\text{ nm}$.

²⁾ Spannungswerte werden mit einer Stromeinprägedauer von 1 ms und einer Genauigkeit von $\pm 0,1\text{ V}$ ermittelt.
Voltages are tested at a current pulse duration of 1 ms and a tolerance of $\pm 0.1\text{ V}$.

Relative spektrale Emission $I_{rel} = f(\lambda)$, $T_A = 25\text{ °C}$, $I_F = 10\text{ mA}$

Relative Spectral Emission

$V(\lambda)$ = spektrale Augenempfindlichkeit

Standard eye response curve

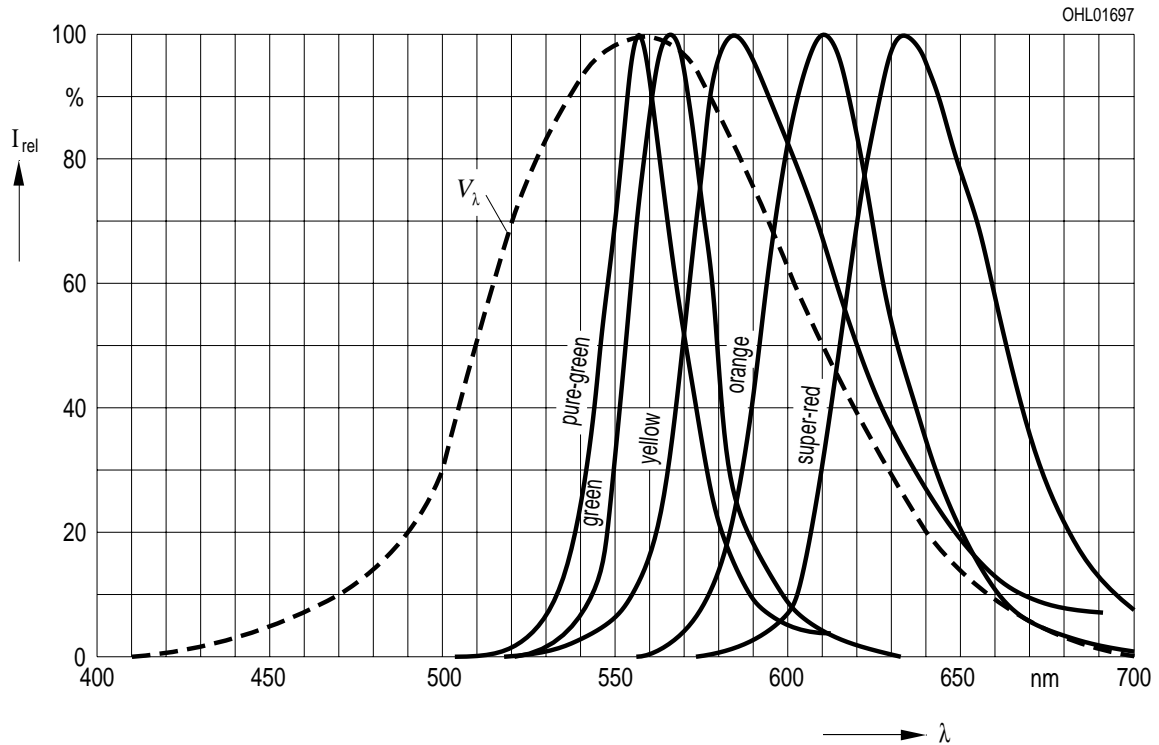

Abstrahlcharakteristik $I_{rel} = f(\varphi)$

Radiation Characteristic

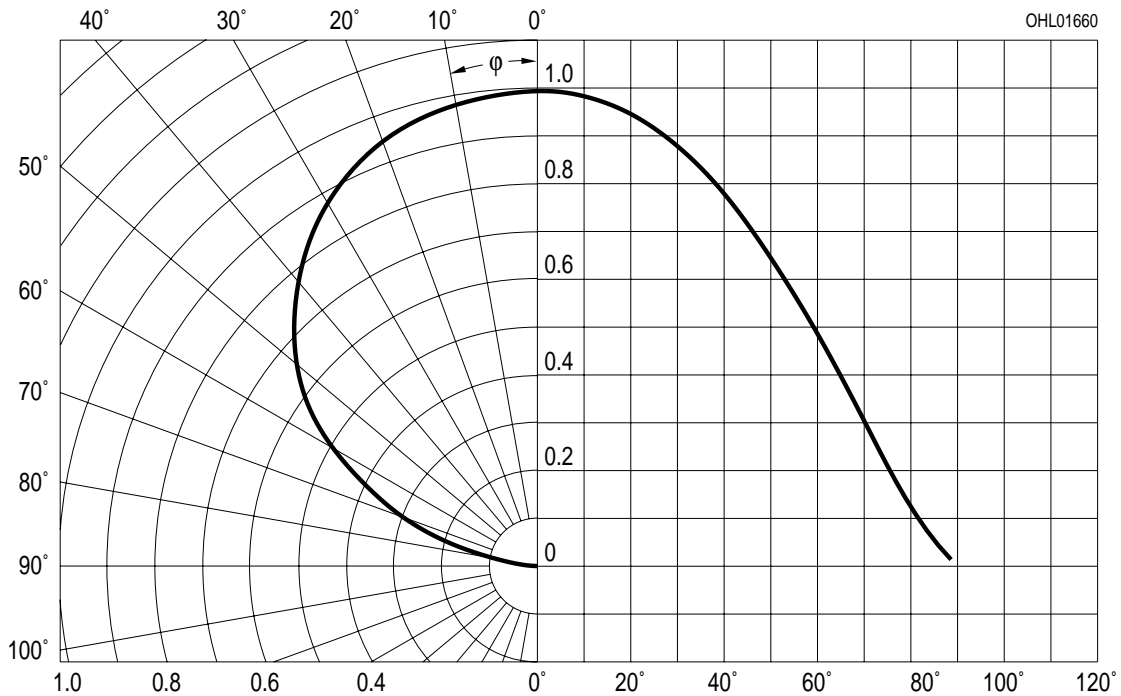

Durchlassstrom $I_F = f(V_F)$
Forward Current

$T_A = 25\text{ °C}$

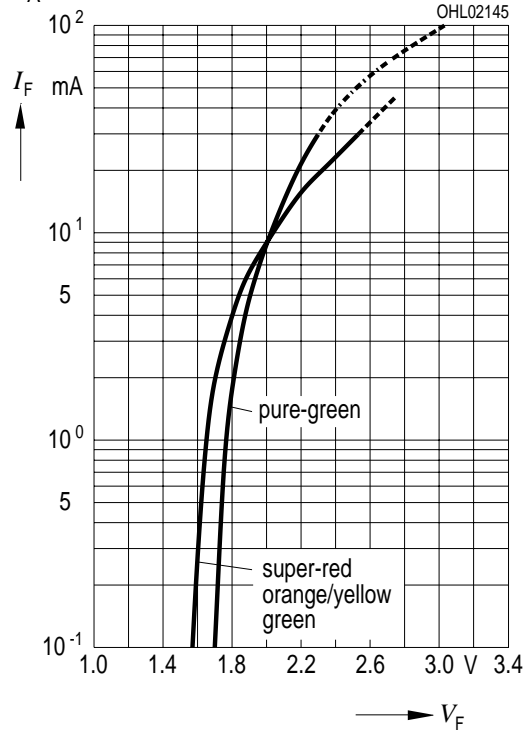

Relative Lichtstärke $I_V/I_{V(10\text{ mA})} = f(I_F)$
Relative Luminous Intensity

$T_A = 25\text{ °C}$

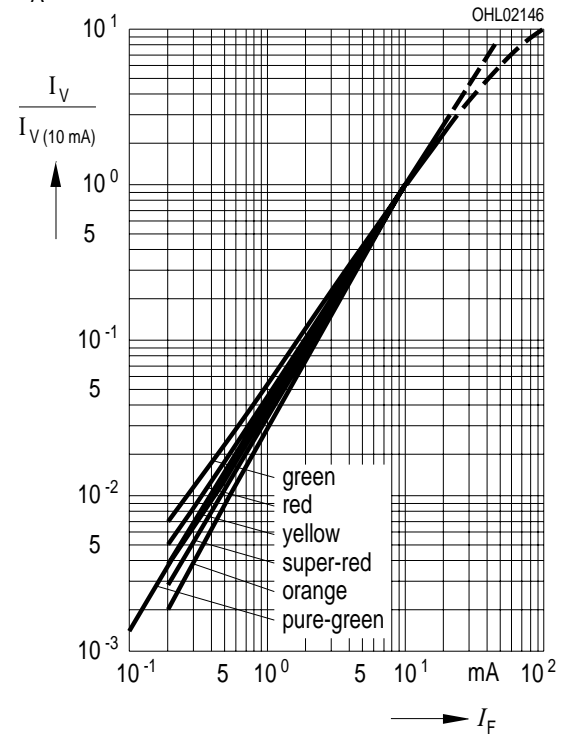

Maximal zulässiger Durchlassstrom $I_F = f(T)$
Max. Permissible Forward Current

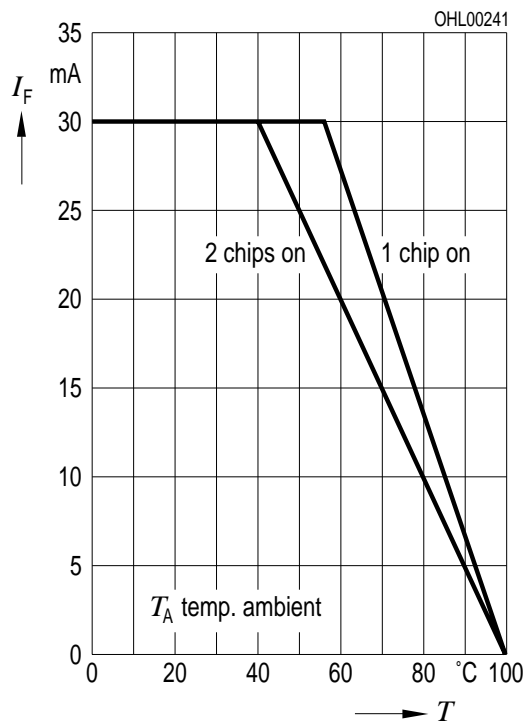

Maximal zulässiger Durchlassstrom $I_F = f(T)$
Max. Permissible Forward Current

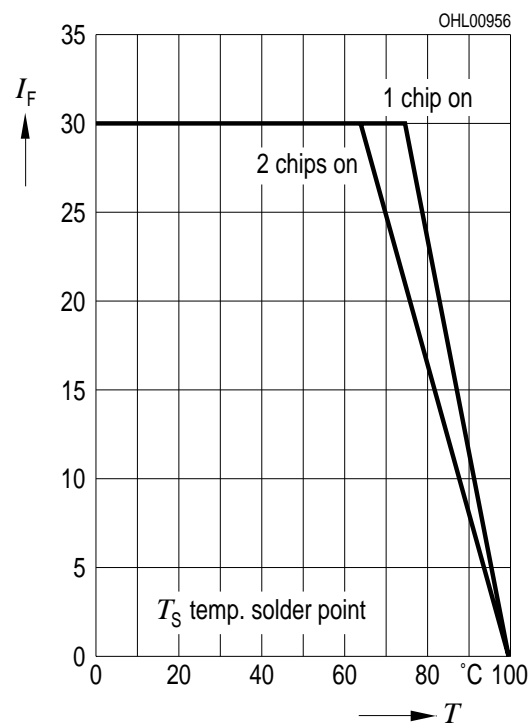

Relative Lichtstärke $I_V/I_{V(25\text{ °C})} = f(T_A)$

Relative Luminous Intensity

$I_F = 10\text{ mA}$

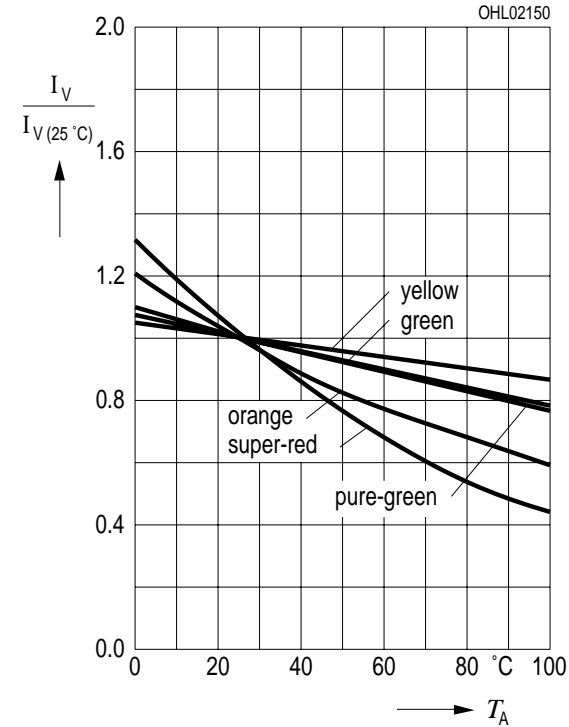

Zulässige Impulsbelastbarkeit $I_F = f(t_p)$

Permissible Pulse Handling Capability

Duty cycle $D =$ parameter, $T_A = 25\text{ °C}$

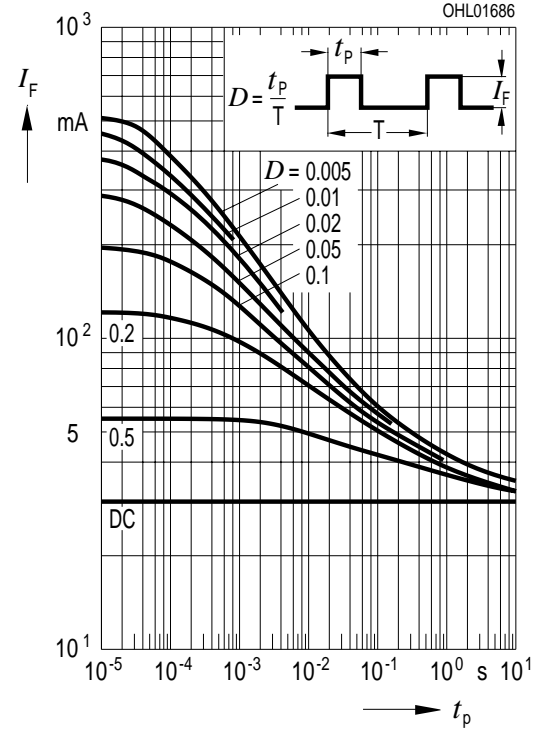

Maßzeichnung
Package Outlines

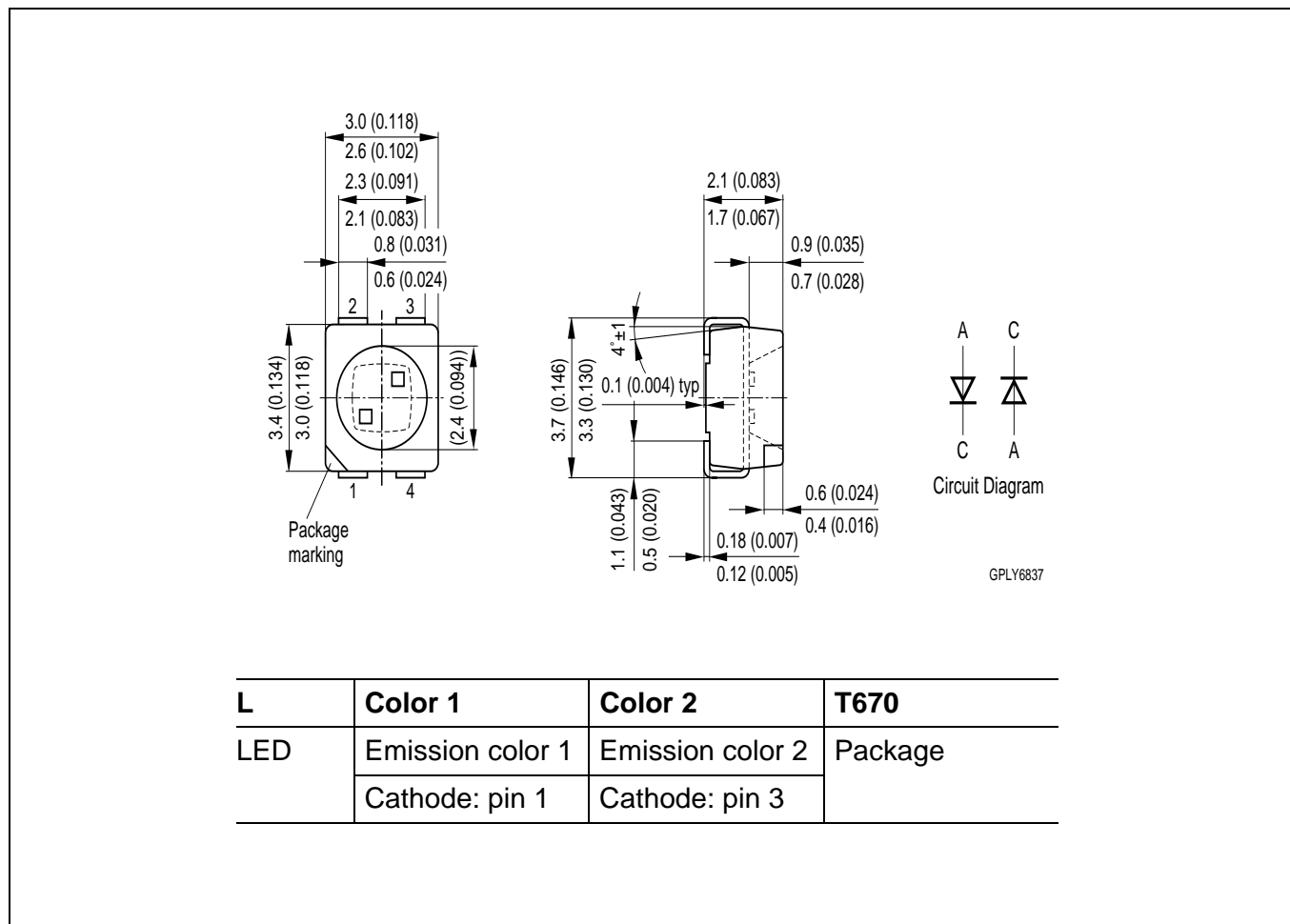

Maße werden wie folgt angegeben: mm (inch) / Dimensions are specified as follows: mm (inch).

Kathodenkennung: abgeschrägte Ecke
Cathode mark: bevelled edge
Gewicht / Approx. weight: 35 mg

Lötbedingungen Vorbehandlung nach JEDEC Level 2
Soldering Conditions Preconditioning acc. to JEDEC Level 2

IR-Reflow Lötprofil (nach IPC 9501)
IR Reflow Soldering Profile (acc. to IPC 9501)

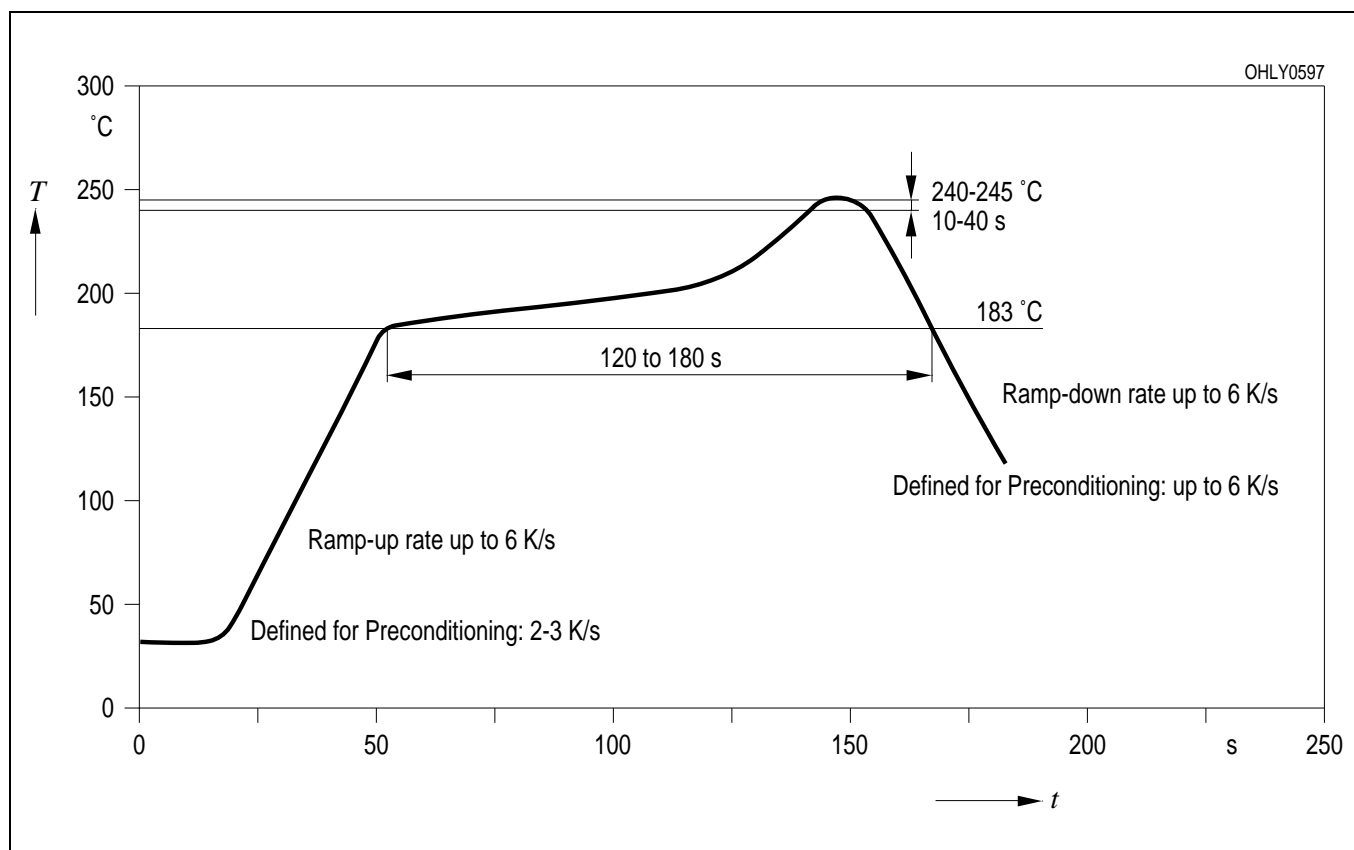

Wellenlöten (TTW) (nach CECC 00802)
TTW Soldering (acc. to CECC 00802)

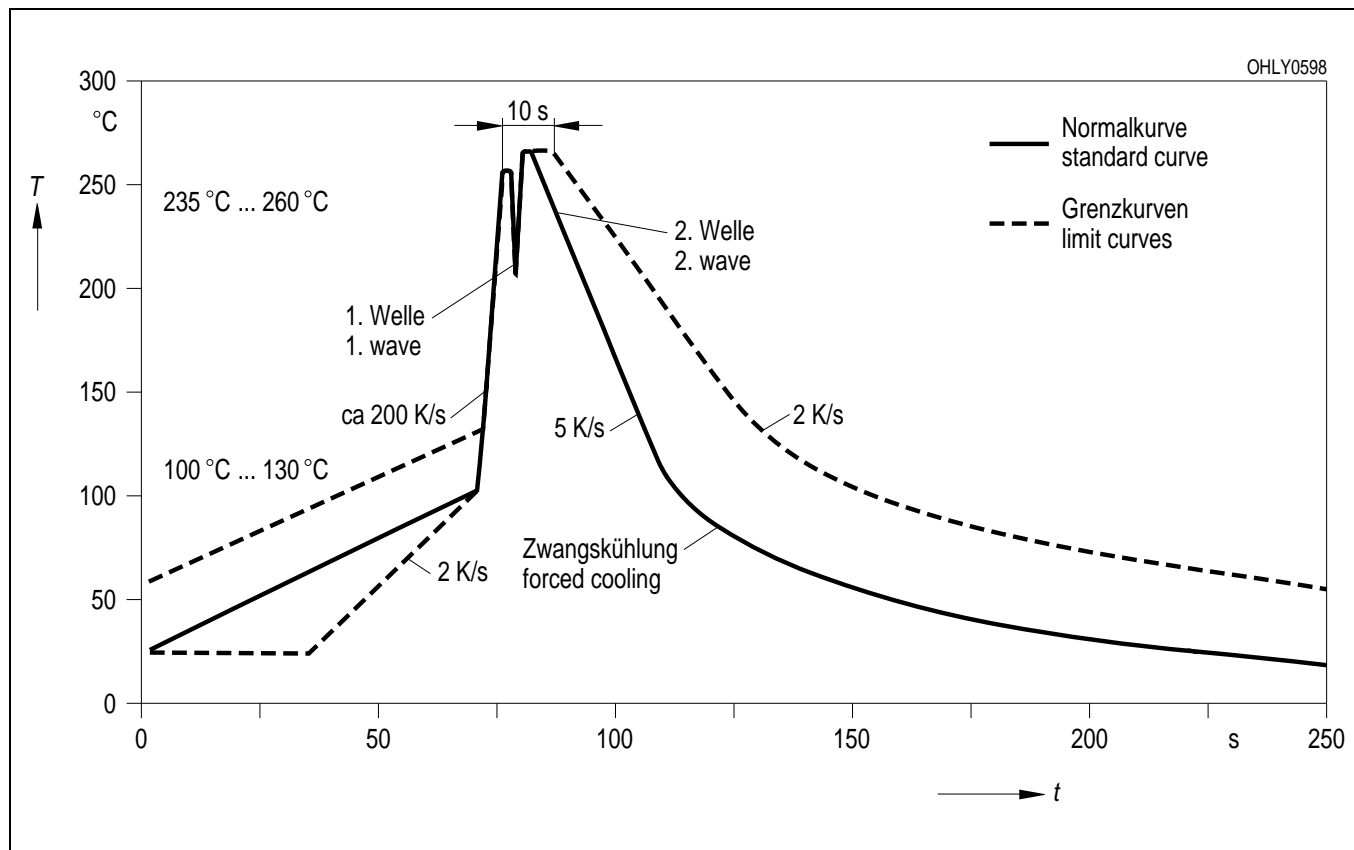

Empfohlenes Lötpad Design IR Reflow Löten
Recommended Solder Pad IR Reflow Soldering

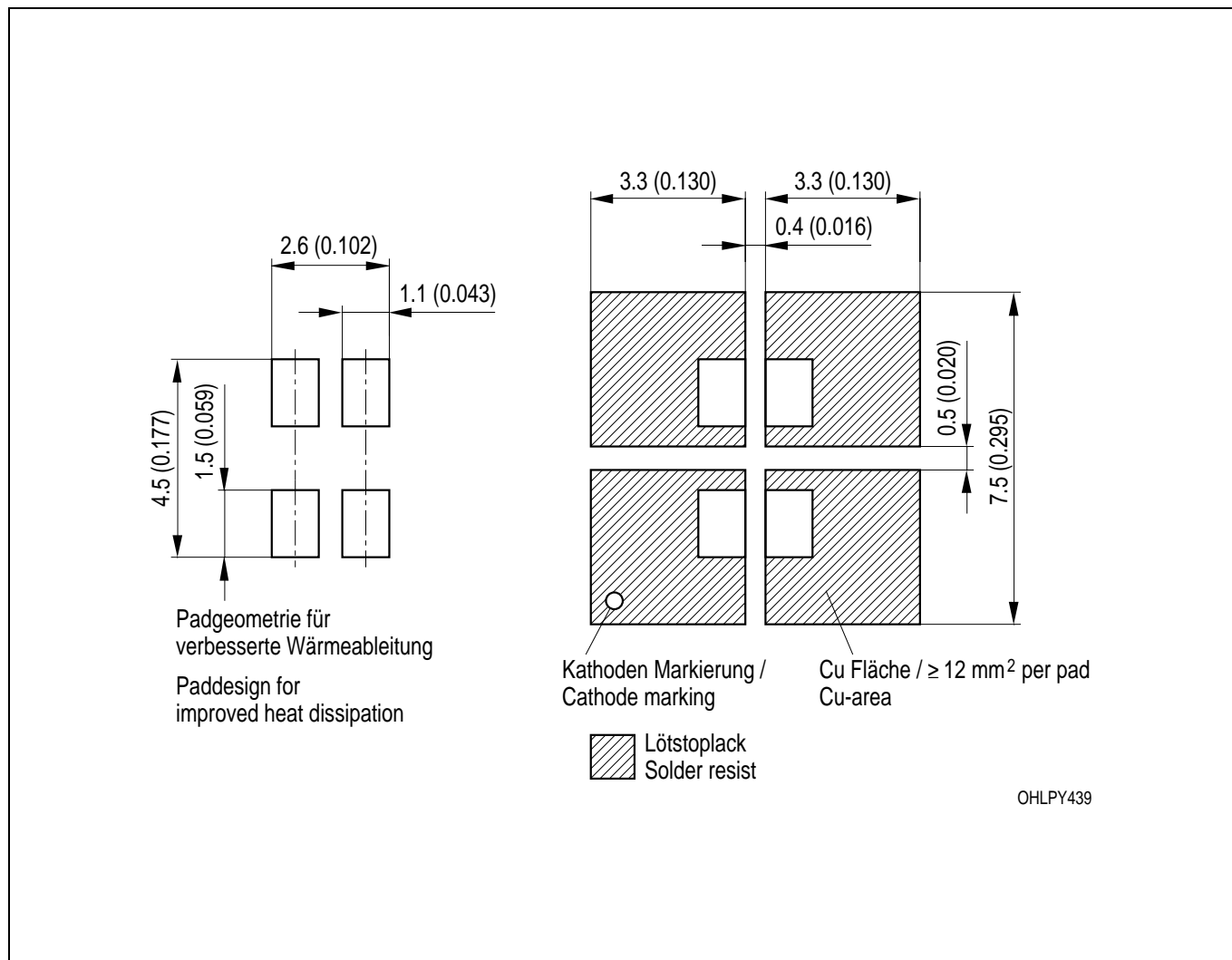

Maße werden wie folgt angegeben: mm (inch) / Dimensions are specified as follows: mm (inch).

Empfohlenes Lötpad Design Wellenlöten (TTW)
Recommended Solder Pad TTW Soldering

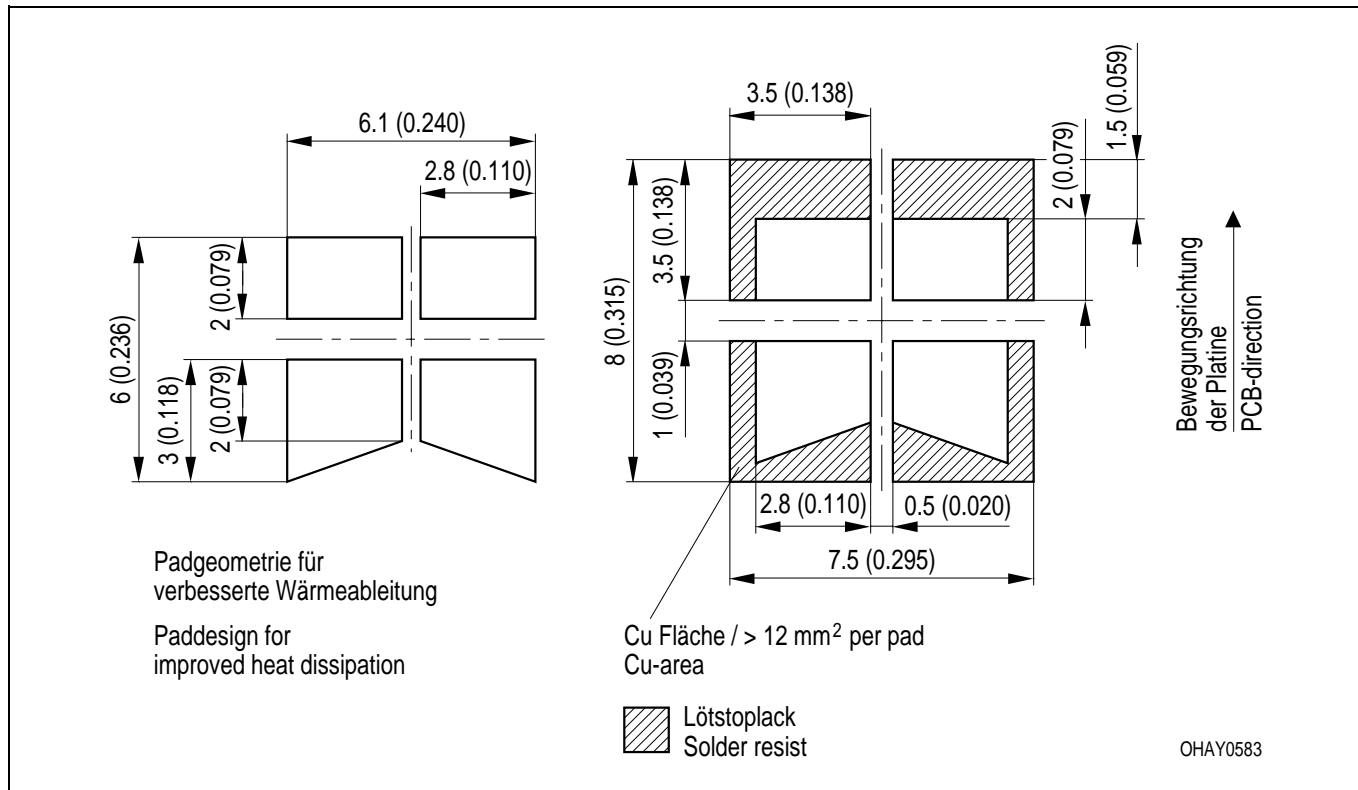

Maße werden wie folgt angegeben: mm (inch) / Dimensions are specified as follows: mm (inch).

Gurtung / Polarität und Lage

Verpackungseinheit 2000/Rolle, ø180 mm
oder 8000/Rolle, ø330 mm

Method of Taping / Polarity and Orientation

Packing unit 2000/reel, ø180 mm
or 8000/reel, ø330 mm

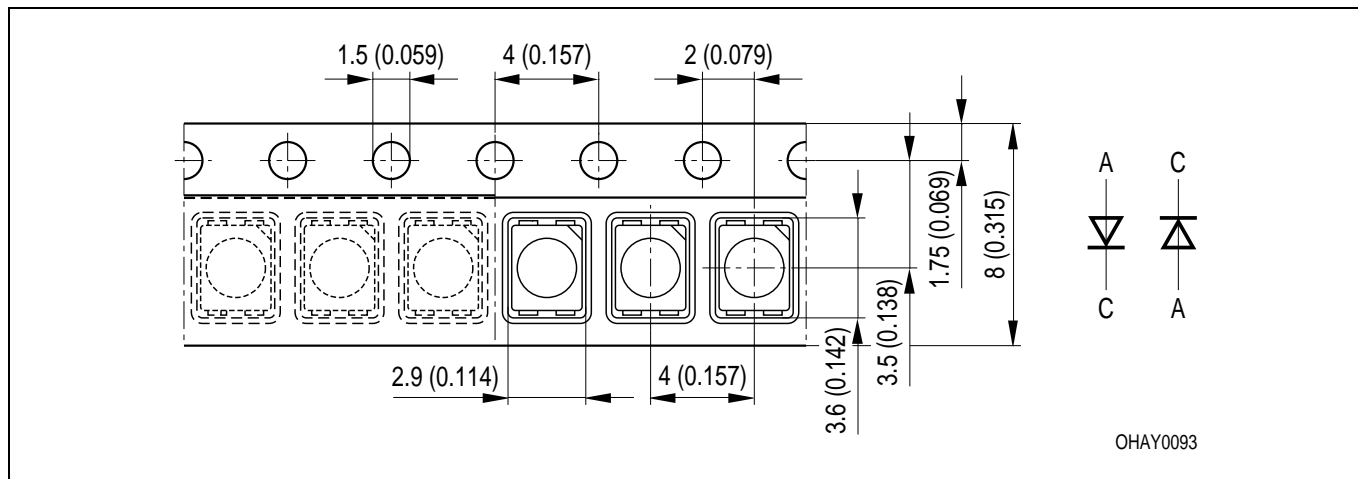

Maße werden wie folgt angegeben: mm (inch) / Dimensions are specified as follows: mm (inch).

Revision History: 2003-03-04		Date of change
Previous Version: 2002-09-18		
Page	Subjects (major changes since last revision)	
3	note changed	
3	luminous Intensity of LOP T670 for pure green	
5	dominant wavelength (yellow)	
13	graphic (taping)	
5	value (wavelength yellow)	
14	annotations	2002-07-23
4, 5	value (reverse voltage from 5 V to 12 V)	2002-09-18

Published by OSRAM Opto Semiconductors GmbH
Wernerwerkstrasse 2, D-93049 Regensburg

© All Rights Reserved.

Attention please!

The information describes the type of component and shall not be considered as assured characteristics. All typical data and graphs are basing on representative samples, but don't represent the production range. If requested, e.g. because of technical improvements, these typ. data will be changed without any further notice. Terms of delivery and rights to change design reserved. Due to technical requirements components may contain dangerous substances. For information on the types in question please contact our Sales Organization. If printed or downloaded, please find the latest version in the Internet.

Packing

Please use the recycling operators known to you. We can also help you – get in touch with your nearest sales office. By agreement we will take packing material back, if it is sorted. You must bear the costs of transport. For packing material that is returned to us unsorted or which we are not obliged to accept, we shall have to invoice you for any costs incurred.

Components used in life-support devices or systems must be expressly authorized for such purpose! Critical components ¹ may only be used in life-support devices or systems ² with the express written approval of OSRAM OS.

¹ A critical component is a component used in a life-support device or system whose failure can reasonably be expected to cause the failure of that life-support device or system, or to affect its safety or the effectiveness of that device or system.

² Life support devices or systems are intended (a) to be implanted in the human body, or (b) to support and/or maintain and sustain human life. If they fail, it is reasonable to assume that the health of the user may be endangered.