

T-1³/₄ (5mm) Ultra Bright AS AlInGaP Yellow LED Lamps

- LTL2F3QYK 8degree
- LTL2H3QYK 15degree
- LTL2P3QYK 22degree
- LTL2R3QYK 30degree

Features

- High luminous intensity output.
- Low power consumption.
- High efficiency.
- Versatile mounting on P.C. board or panel.
- I.C. compatible/low current requirements.
- Popular T-1 ³/₄ diameter.

Description

The source color devices are made with Aluminum Indium Gallium Phosphide on Gallium Arsenide light emitting diode.

The devices are made with water clear epoxy package, and with 8, 15, 22 and 30 degrees of viewing angle.

Application

Available for half-outdoor and outdoor application.

- Message sign.
- Traffic sign.
- Automotive.

Package Dimensions

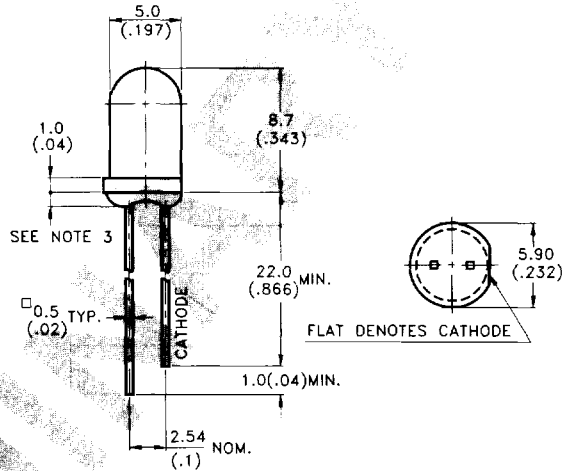

Notes:

1. All dimensions are in millimeters (inches).
2. Tolerance is $\pm 0.25\text{mm}$ (.010") unless otherwise noted.
3. Protruded resin under flange is 1.0mm (.04") max.
4. Lead spacing is measured where the leads emerge from the package.

Devices

Part No. LTL	Lens		Source Color
	Color	Diffusion	
2F3QYK	Water Clear	Non-diffused	AlInGaP Yellow
2H3QYK	Water Clear	Non-diffused	AlInGaP Yellow
2P3QYK	Water Clear	Non-diffused	AlInGaP Yellow
2R3QYK	Water Clear	Non-diffused	AlInGaP Yellow

Absolute Maximum Ratings at Ta=25 °C

Parameter	Yellow	Unit
Power Dissipation	120	mW
Peak Forward Current (1/10 Duty Cycle, 0.1ms Pulse Width)	160	mA
Continuous Forward Current	50	mA
Reverse Voltage	4	V
Operating Temperature Range	-40 °C to + 100 °C	
Storage Temperature Range	-55 °C to + 100 °C	
Lead Soldering Temperature [1.6mm(0.063")From Body]	260 °C for 5 Seconds	

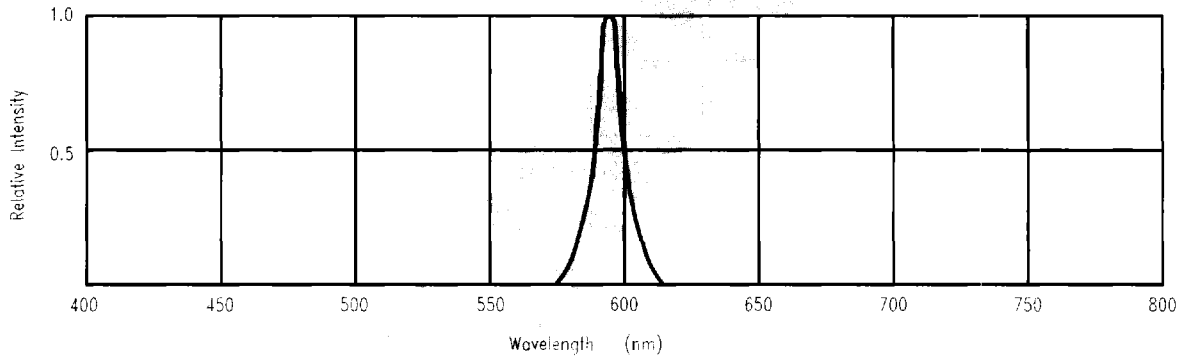

Fig.1 RELATIVE INTENSITY VS. WAVELENGTH

Electrical/Optical Characteristics and Curves at Ta=25 °C

Parameter	Symbol	Part No. LTL	Min.	Typ.	Max.	Unit	Test Condition
Luminous Intensity	Iv	2F3QYK	1000	3600		mcd	If=20mA Note 1 Note 2
		2F3QYK-ST	1000		3600		
		2F3QYK-TU	1800		6400		
		2H3QYK	560	2000			
		2H3QYK-RS	560		2000		
		2H3QYK-ST	1000		3600		
		2P3QYK	320	1400			
2P3QYK-QR	320		1120				
		2P3QYK-RS	560		2000		
		2R3QYK	180	900			
		2R3QYK-PQ	180		640		
		2R3QYK-QR	320		1120		
Viewing Angle	2 θ 1/2	2F3QYK 2H3QYK 2P3QYK 2R3QYK		8 15 22 30		deg	Note 3 (Fig.6)
Peak Emission Wavelength	λP			595		nm	Measurement @ peak (Fig.1)
Dominant Wavelength	λd			592		nm	Note 6
Spectral Line Half-Width	Δλ			15		nm	
Forward Voltage	V _F			2.0	2.4	V	If = 20mA
Reverse Current	I _R				100	μA	V _R = 4V
Capacitance	C			40		PF	V _F =0, f=1MHZ

Notes:

- Luminous intensity is measured with a light sensor and filter combination that approximates the CIE eye-response curve.
- Luminous intensity rank classified products support two ranks.
- θ_{1/2} is the off-axis angle at which the luminous intensity is half the axial luminous intensity.
- Iv classification code is marked on each packing bag.
- The Iv guarantee should be added ± 15%.
- The dominant wavelength, λ_d is derived from the CIE Chromaticity Diagram and represents the single wavelength which defines the color of the device.

Typical Electrical/Optical Characteristic Curves (25 °C Ambient Temperature Unless Otherwise Noted)

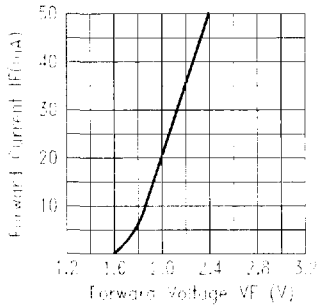

FIG. 2 FORWARD CURRENT VS. FORWARD VOLTAGE

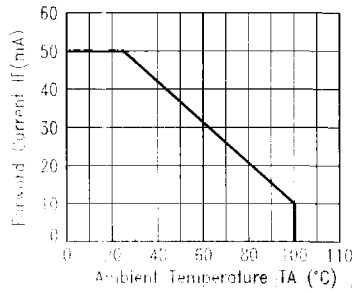

FIG. 3 FORWARD CURRENT DERATING CURVE

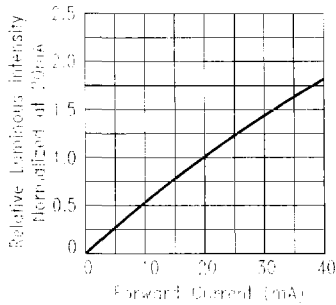

FIG. 4 RELATIVE LUMINOUS INTENSITY VS. FORWARD CURRENT

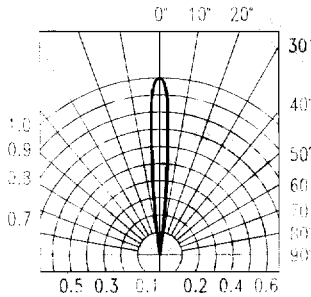

Fig.5-1 SPATIAL DISTRIBUTION

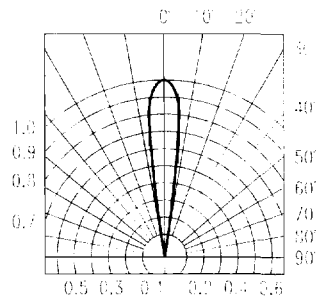

Fig.5-2 SPATIAL DISTRIBUTION

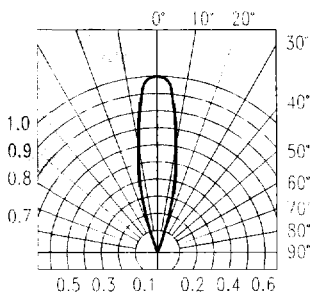

Fig.5-3 SPATIAL DISTRIBUTION

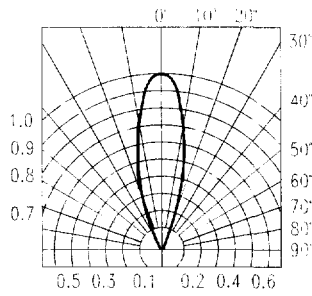

Fig.5-4 SPATIAL DISTRIBUTION

ULTRA BRIGHT LAMPS
CLUSTER & CHMSL