

Features

- **Low Voltage Programmable Logic Device**
Wide Power Supply Range - 3.0 V to 5.5 V
Ideal for Battery Powered Systems
- **High Speed Operation**
20 ns max Propagation Delay at $V_{CC} = 3.0\text{ V}$
- **Full Military, Commercial and Industrial Temperature Ranges**
- **Familiar 22V10 Logic Architecture**
- **Low Power 3-Volt CMOS Operation**

AT22LV10L		AT22LV10	$V_{CC} = 3.6\text{ V}$
Temp	Com./Mil.	Com./Mil.	
I_{CC} (mA)	4 / 5	35 / 45	

- **CMOS and TTL Compatible Inputs and Outputs**
10 μA Leakage Maximum
- **Reprogrammable - Tested 100% for Programmability**
- **High Reliability CMOS Technology**
2000 V ESD Protection
200 mA Latchup Immunity
- **Dual-In-Line and Surface Mount Packages**

Logic Diagram

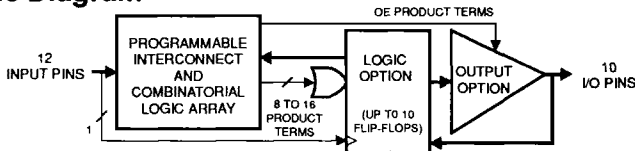

Description

The AT22LV10 and AT22LV10L are low voltage compatible CMOS high performance Erasable Programmable Logic Devices (EPLDs). Speeds down to 20 ns and power dissipation as low as 14.4 mW are offered. All speed ranges are specified over the 3.0 V to 5.5 V range. All pins offer a low $\pm 10\ \mu\text{A}$ leakage.

The AT22LV10L provides the optimum low power CMOS EPLD solution, with low DC power (1 mA typical at $V_{CC} = 3.3\text{ V}$) and full CMOS output levels. The AT22LV10L significantly reduces total system power, allowing battery powered operation.

Full CMOS output levels help reduce power in many other system components.

The AT22LV10 and AT22LV10L logic architectures are identical to the familiar 22V10. Each output is allocated from eight to 16 product terms, which allows highly complex logic functions to be realized.

Two additional product terms are included to provide synchronous preset and asynchronous reset. These terms are common to all ten registers. All registers are automatically cleared upon power up.

Register Preload simplifies testing. A Security Fuse prevents unauthorized copying of programmed fuse patterns.

Pin Configurations

Pin Name	Function
CLK/IN	Clock and Logic Input
IN	Logic Inputs
I/O	Bidirectional Buffers
*	No Internal Connection
VCC	3.0 V to 5.5 V Supply

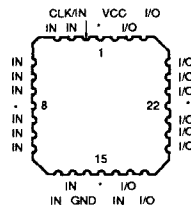
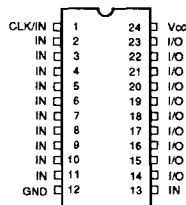

**Low Voltage
UV Erasable
Programmable
Logic Device**

Absolute Maximum Ratings*

Temperature Under Bias.....	-55°C to +125°C
Storage Temperature.....	-65°C to +150°C
Voltage on Any Pin with Respect to Ground.....	-2.0 V to +7.0 V ⁽¹⁾
Voltage on Input Pins with Respect to Ground During Programming.....	-2.0 V to +14.0 V ⁽¹⁾
Programming Voltage with Respect to Ground.....	-2.0 V to +14.0 V ⁽¹⁾
Integrated UV Erase Dose.....	7258 W-sec/cm ²

*NOTICE: Stresses beyond those listed under "Absolute Maximum Ratings" may cause permanent damage to the device. This is a stress rating only and functional operation of the device at these or any other conditions beyond those indicated in the operational sections of this specification is not implied. Exposure to absolute maximum rating conditions for extended periods may affect device reliability.

Note:

1. Minimum voltage is -0.6 V dc which may undershoot to -2.0 V for pulses of less than 20 ns. Maximum pin voltage is $V_{CC}+0.75$ V dc which may overshoot to $V_{CC}+2.0$ V for pulses of less than 20 ns.

Logic Options

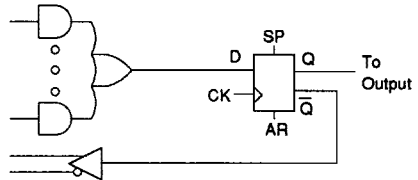
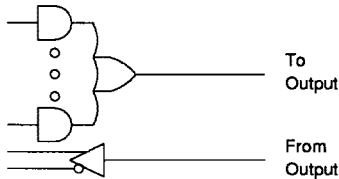

Output Options

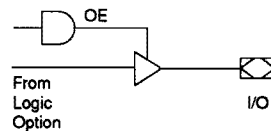
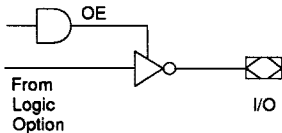

D.C. and A.C. Operating Conditions

	Commercial AT22LV10/L -20, -25, -30	Industrial AT22LV10/L -20, -25, -30	Military AT22LV10/L -25, -30, -35
Operating Temperature (Case)	0°C - 70°C	-40°C - 85°C	-55°C - 125°C
V _{CC} Power Supply	3.0 V to 5.5 V	3.0 V to 5.5 V	3.0 V to 5.5 V

Operating Modes

Mode	24-Pin DIP	1	5	8	13	I/Os	V _{CC} (24)
	28-Pin JLCC	2	6	10	16	I/Os	V _{CC} (28)
"EPLD"	X ⁽¹⁾	X	X	X	X	I/O	3.0 V to 5.5 V
Program	V _{PP}	X / V _H ⁽²⁾	X	V _{PP}	DIN	6 V	
PGM Verify	V _{PP}	X/V _H	X	V _{IL}	DO _{UT}	6 V	
PGM Inhibit	V _{PP}	X/V _H	X	V _{IH}	High Z	6 V	
Preload	X	X	V _H	X	DIN	3.0 V to 5.5 V	

Notes: 1. X can be V_{IL} or V_{IH}.

2. V_H = 11.0 V to 14.0 V

D.C. Characteristics

Symbol	Parameter	Condition	Min	Typ	Max	Units		
I _{LI}	Input Load Current	V _{IN} = -0.1 V to V _{CC} +1 V			10	μA		
I _{LO}	Output Leakage Current	V _{OUT} = -0.1 V to V _{CC} +0.1 V			10	μA		
I _{CC}	Power Supply Current	V _{CC} = 3.6 V / 5.5 V, V _{IN} = GND, Outputs Open	AT22LV10		Com.	20/50	35/90	mA
					Ind., Mil.	20/50	45/100	mA
		AT22LV10L ⁽²⁾		Com.	1/2	4/12	mA	
				Ind., Mil.	1/2	5/15	mA	
I _{CC2}	Clocked Power Supply Current	f = 1 MHz, V _{CC} = 3.6 V / 5.5 V, Outputs Open	AT22LV10L ⁽²⁾		Com.	3/5	7/15	mA
					Ind., Mil.	3/5	10/20	mA
I _{OS} ⁽¹⁾	Output Short Circuit Current	V _{OUT} = 0.5 V				-90	mA	
V _{IL1}	Input Low Voltage	4.5 V ≤ V _{CC} ≤ 5.5 V	-0.6		0.8	V		
V _{IL2}	Input Low Voltage	3.0 V ≤ V _{CC} < 4.5 V	-0.6		0.6	V		
V _{IH}	Input High Voltage		2.0		V _{CC} +0.75	V		
V _{OL}	Output Low Voltage V _{IN} = V _{IH} or V _{IL}	V _{CC} = 3.0 V	Com., Ind./Mil.		I _{OL} = 8 mA / 6 mA		0.5	V
		V _{CC} = 4.5 V	Com., Ind./Mil.		I _{OL} = 16 mA / 12 mA		0.5	V
		V _{CC} = 3.0 V	Com., Ind./Mil.		I _{OL} = 6 mA / 4 mA		0.35	V
V _{OH}	Output High Voltage	V _{IN} = V _{IH} or V _{IL} , V _{CC} = 3.0 V / 4.5 V	I _{OH} = -100 μA		V _{CC} -0.3			V
			I _{OH} = -0.4 mA / -4.0 mA		2.4			V

Notes: 1. Not more than one output at a time should be shorted. Duration of short circuit test should not exceed 30 sec. 2. See I_{CC} vs. Frequency curves in the back of this data sheet.

A.C. Characteristics for the AT22LV10

Symbol	Parameter	AT22LV10-20			AT22LV10-25			AT22LV10-30			Units
		Min	Typ	Max	Min	Typ	Max	Min	Typ	Max	
t _{PD}	Input or Feedback to Non-Registered Output		12	20		15	25		20	30	ns
t _{EA}	Input to Output Enable			20		15	25		20	30	ns
t _{ER}	Input to Output Disable			20		15	25		20	30	ns
t _{CF}	Clock to Feedback	0	4	9	0	5	9	0	6	10	ns
t _{CO}	Clock to Output	0	8	14	0	10	17	0	12	20	ns
t _S	Input or Feedback Setup Time	10	6		12	7		15	8		ns
t _H	Hold Time	0			0			0			ns
t _P	Clock Period	10			12			14			ns
t _W	Clock Width	5			6			7			ns
F _{MAX}	External Feedback 1/(t _S +t _{CO})			41.6			34.5			28.5	MHz
	Internal Feedback 1/(t _S + t _{CF})			52.6			47.6			40.0	MHz
	No Feedback 1/(t _P)			100.0			83.3			71.4	MHz
t _{AW}	Asynchronous Reset Width	20	12		25	15		30	18		ns
t _{AR}	Asynchronous Reset, Synchronous Preset, Recovery Time	20	12		25	15		30	18		ns
t _{AP}	Asynchronous Reset to Registered Output Reset		15	25		18	28		20	30	ns



A.C. Waveforms ⁽¹⁾

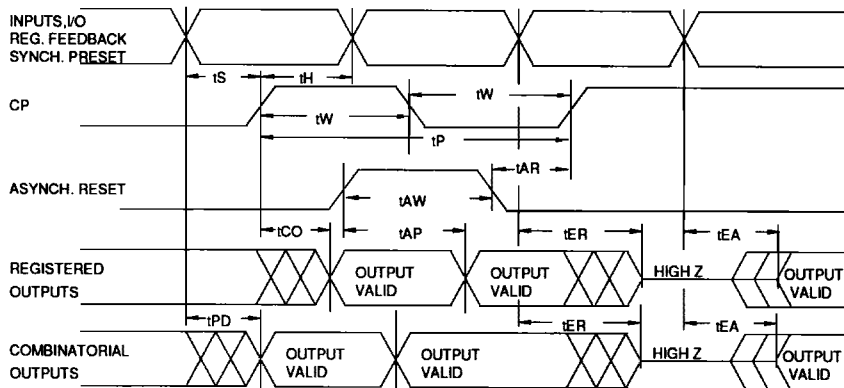

Note: 1. Timing measurement reference is 1.5 V. Input AC driving levels are 0.0 V and 3.0 V, unless otherwise specified.

A.C. Characteristics for the AT22LV10L

Symbol	Parameter	AT22LV10L-25			AT22LV10L-30			AT22LV10L-35			Units
		Min	Typ	Max	Min	Typ	Max	Min	Typ	Max	
t _{PD}	Input or Feedback to Non-Registered Output		15	25		20	30		25	35	ns
t _{EA}	Input to Output Enable		15	25		20	30		25	35	ns
t _{ER}	Input to Output Disable		15	25		20	30		25	35	ns
t _{CF}	Clock to Feedback	0	5	9	0	6	10		7	11	ns
t _{CO}	Clock to Output	0	10	14	0	12	17		15	20	ns
t _{SF}	Feedback Setup Time	12	7		15	10		18	12		ns
t _S	Input Setup Time	17	15		20	15		22	15		ns
t _H	Hold Time	0			0			0			ns
t _P	Clock Period	12			14			16			ns
t _W	Clock Width	6			7			8			ns
F _{MAX}	External Feedback 1/(t _S +t _{CO})			32.2			27.0			23.8	MHz
	Internal Feedback 1/(t _{SF} + t _{CF})			47.6			40.0			34.4	MHz
	No Feedback 1/(t _P)			83.3			71.4			62.5	MHz
t _{AW}	Asynchronous Reset Width	25	15		30	18		35	20		ns
t _{AR}	Asynchronous Reset Recovery Time	25	15		30	18		35	20		ns
t _{AP}	Asynchronous Reset to Registered Output Reset		18	28		20	30		22	35	ns

Input Test Waveforms and Measurement Levels

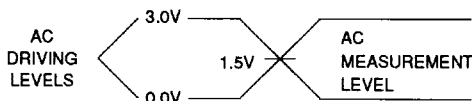

t_R, t_F < 5 ns (10% to 90%)

Output Test Loads:

Commercial

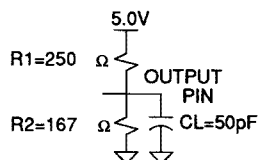

Military

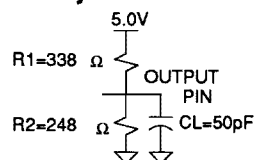

Functional Logic Diagram AT22LV10/L

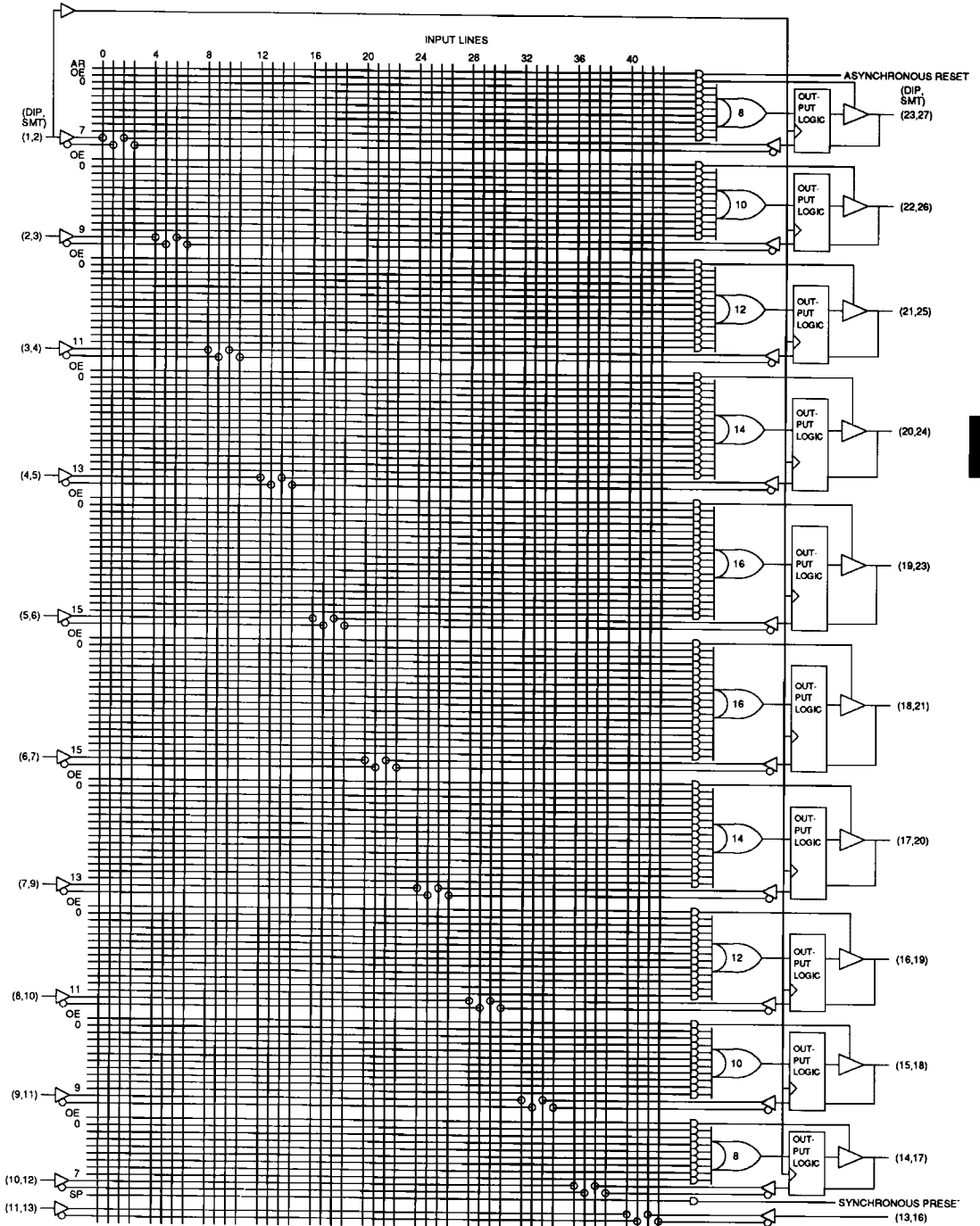

7

Preload of Registered Outputs

The registers in the AT22LV10 and AT22LV10L are provided with circuitry to allow loading of each register asynchronously with either a high or a low. This feature will simplify testing since any state can be forced into the registers to control test sequencing. A V_{IH} level on the I/O pin will force the register high; a V_{IL} will force it low, independent of the polarity bit (C0) setting. The PRELOAD state is entered by placing an 11 V to 14 V signal on pin 8 on DIPs, and pin 10 on SMPs. When the clock pin is pulsed high, the data on the I/O pins is placed into the ten registers.

Level forced on registered output pin during PRELOAD cycle.	Register state After Cycle
V_{IH}	High
V_{IL}	Low

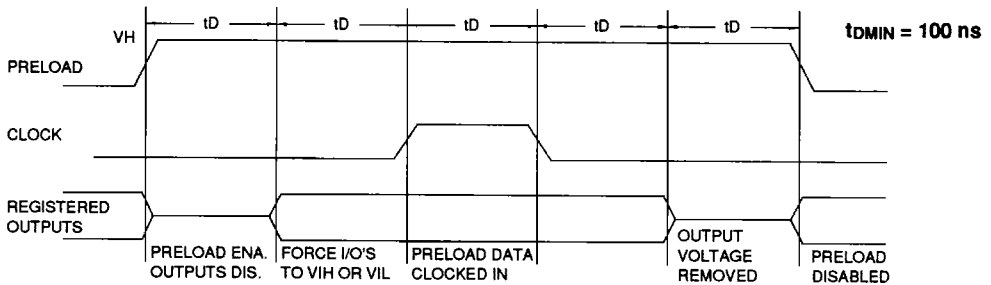

Power Up Reset

The registers in the AT22LV10 and AT22LV10L are designed to reset during power up. At a point delayed slightly from V_{CC} crossing 2.5 V, all registers will be reset to the low state. The output state will depend on the polarity of the output buffer.

This feature is critical for state machine initialization. However, due to the asynchronous nature of reset and the uncertainty of how V_{CC} actually rises in the system, the following conditions are required:

- 1) The V_{CC} rise must be monotonic,
- 2) After reset occurs, all input and feedback setup times must be met before driving the clock pin high, and
- 3) The clock must remain stable during t_{PR} .

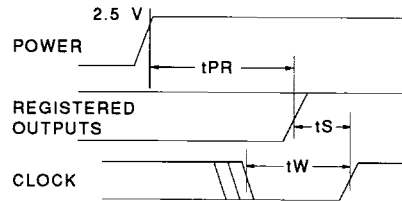

Parameter	Description	Min	Typ	Max	Units
t_{PR}	Power-Up Reset Time		600	1000	ns

Pin Capacitance $(f = 1 \text{ MHz}, T = 25^\circ\text{C})^{(1)}$

	Typ	Max	Units	Conditions
C_{IN}	5	8	pF	$V_{IN} = 0 \text{ V}$
C_{OUT}	6	8	pF	$V_{OUT} = 0 \text{ V}$

Note: 1. Typical values for nominal supply voltage. This parameter is only sampled and is not 100% tested.

Erase Characteristics

The entire fuse array of an AT22LV10 or AT22LV10L is erased after exposure to ultraviolet light at a wavelength of 2537 Å. Complete erasure is assured after a minimum of 20 minutes exposure using 12,000 $\mu\text{W}/\text{cm}^2$ intensity lamps spaced one inch away from the chip. Minimum erase time for lamps at other in-

tensity ratings can be calculated from the minimum integrated erasure dose of 15 $\text{W}\cdot\text{sec}/\text{cm}^2$. To prevent unintentional erasure, an opaque label is recommended to cover the clear window on any UV erasable EPLD which will be subjected to continuous fluorescent indoor lighting or sunlight.

SUPPLY CURRENT vs. INPUT FREQUENCY

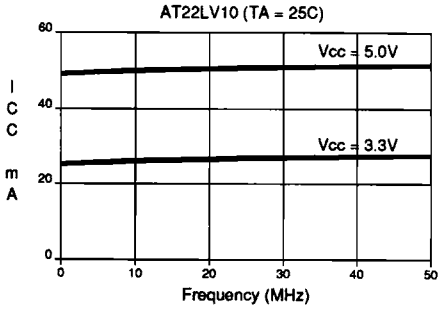

SUPPLY CURRENT vs. INPUT FREQUENCY

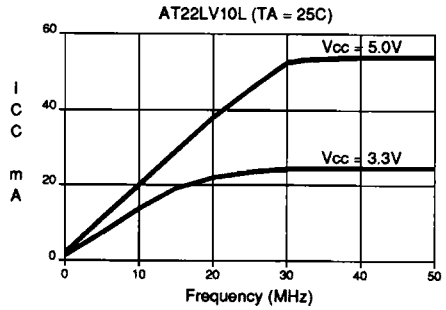

NORMALIZED SUPPLY CURRENT vs. SUPPLY VOLTAGE

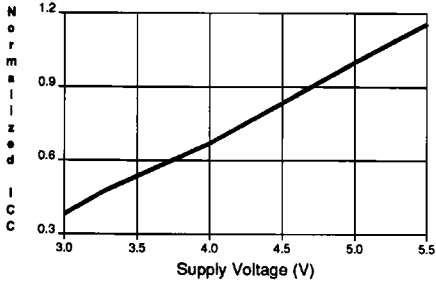

NORMALIZED ICC vs. AMBIENT TEMP.

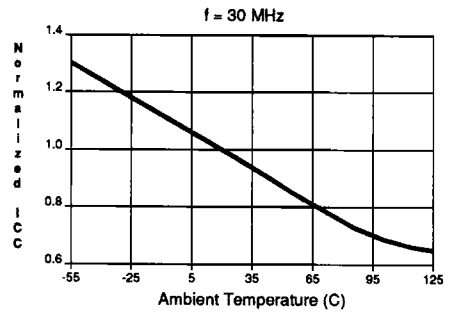

OUTPUT SINK CURRENT vs. SUPPLY VOLTAGE (TA = 25C)

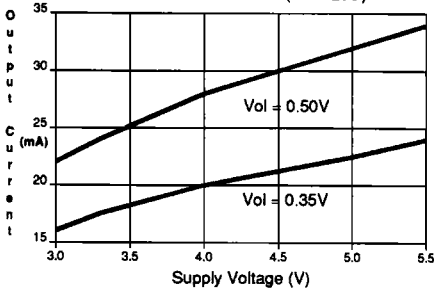

OUTPUT SINK CURRENT vs. OUTPUT VOLTAGE (TA = 25C)

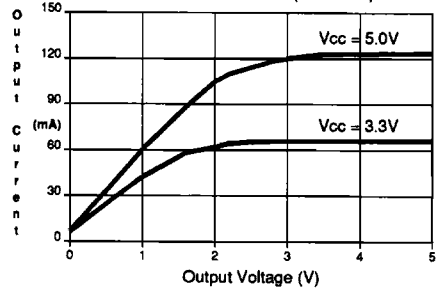

OUTPUT SOURCE CURRENT vs. SUPPLY VOLTAGE (VOH = 2.4V TA = 25C)

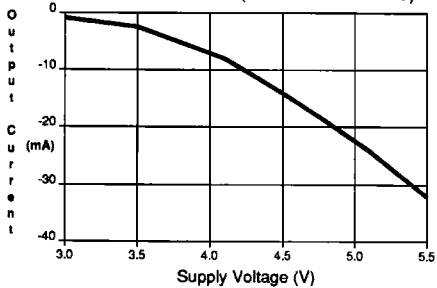

OUTPUT SOURCE CURRENT vs. OUTPUT VOLTAGE (TA = 25C)

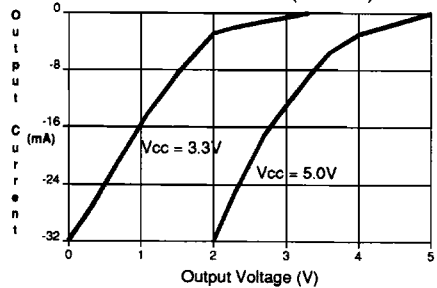

7



NORMALIZED TPD
vs. SUPPLY VOLTAGE

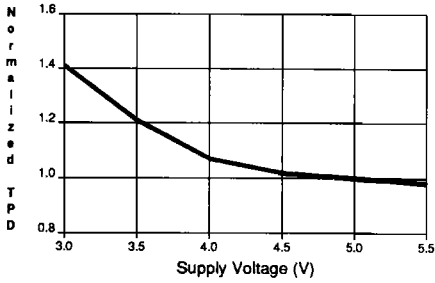

NORMALIZED TPD
vs. TEMPERATURE

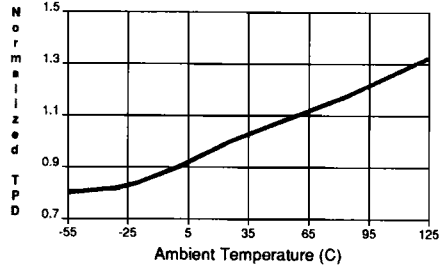

NORMALIZED TCO
vs. SUPPLY VOLTAGE

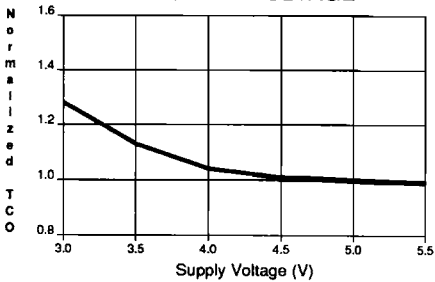

NORMALIZED TCO
vs. TEMPERATURE

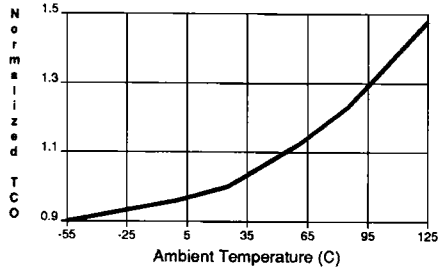

NORMALIZED TS
vs. SUPPLY VOLTAGE

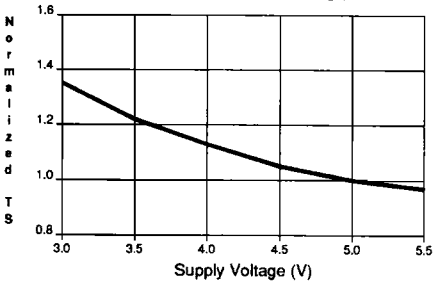

NORMALIZED TS
vs. TEMPERATURE

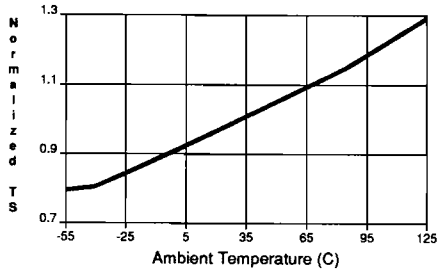

DELTA TPD vs. OUTPUT LOADING
(VCC = 4.5V, OUTPUT LOAD = COMMERCIAL)

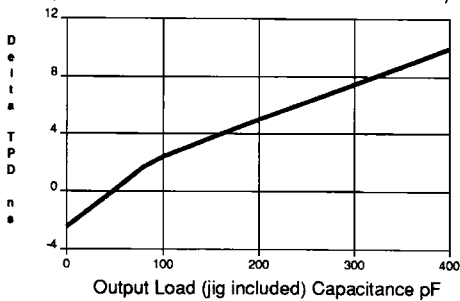

DELTA TCO vs. OUTPUT LOADING
(VCC = 4.5V, OUTPUT LOAD = COMMERCIAL)

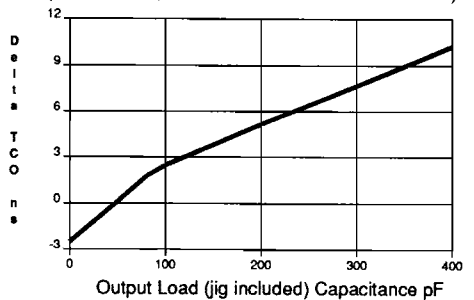

Ordering Information

tpd (ns)	ts (ns)	tco (ns)	Ordering Code	Package	Operation Range
20	10	14	AT22LV10-20DC	24DW3	Commercial (0°C to 70°C)
			AT22LV10-20FC	24C	
			AT22LV10-20GC	24D3	
			AT22LV10-20JC	28J	
			AT22LV10-20KC	28KW	
			AT22LV10-20LC	28LW	
			AT22LV10-20NC	28L	
			AT22LV10-20PC	24P3	
			AT22LV10-20SC	24S	
			AT22LV10-20YC	24CW	
			AT22LV10-20DI	24DW3	Industrial (-40°C to 85°C)
			AT22LV10-20FI	24C	
			AT22LV10-20GI	24D3	
			AT22LV10-20JI	28J	
			AT22LV10-20KI	28KW	
			AT22LV10-20LI	28LW	
			AT22LV10-20NI	28L	
			AT22LV10-20PI	24P3	
			AT22LV10-20SI	24S	
			AT22LV10-20YI	24CW	
AT22LV10-20DM	24DW3	Military (-55°C to 125°C)			
AT22LV10-20FM	24C				
AT22LV10-20GM	24D3				
AT22LV10-20KM	28KW				
AT22LV10-20LM	28LW				
AT22LV10-20NM	28L				
AT22LV10-20YM	24CW				
AT22LV10-20DM/883	24DW3	Military/883D (-55°C to 125°C) Class B, Fully Compliant			
AT22LV10-20FM/883	24C				
AT22LV10-20GM/883	24D3				
AT22LV10-20KM/883	28KW				
AT22LV10-20LM/883	28LW				
AT22LV10-20NM/883	28L				
AT22LV10-20YM/883	24CW				
25	12	17	AT22LV10-25DC	24DW3	Commercial (0°C to 70°C)
			AT22LV10-25FC	24C	
			AT22LV10-25GC	24D3	
			AT22LV10-25JC	28J	
			AT22LV10-25KC	28KW	
			AT22LV10-25LC	28LW	
			AT22LV10-25NC	28L	
			AT22LV10-25PC	24P3	
			AT22LV10-25SC	24S	
			AT22LV10-25YC	24CW	



Ordering Information

tpd (ns)	ts (ns)	tco (ns)	Ordering Code	Package	Operation Range	
25	12	17	AT22LV10-25DI	24DW3	Industrial (-40°C to 85°C)	
			AT22LV10-25FI	24C		
			AT22LV10-25GI	24D3		
			AT22LV10-25JI	28J		
			AT22LV10-25KI	28KW		
			AT22LV10-25LI	28LW		
			AT22LV10-25NI	28L		
			AT22LV10-25PI	24P3		
			AT22LV10-25SI	24S		
AT22LV10-25YI	24CW					
30	15	20	AT22LV10-25DM	24DW3	Military (-55°C to 125°C)	
			AT22LV10-25FM	24C		
			AT22LV10-25GM	24D3		
			AT22LV10-25KM	28KW		
			AT22LV10-25LM	28LW		
			AT22LV10-25NM	28L		
AT22LV10-25YM	24CW					
30	15	20	AT22LV10-25DM/883	24DW3	Military/883D (-55°C to 125°C) Class B, Fully Compliant	
			AT22LV10-25FM/883	24C		
			AT22LV10-25GM/883	24D3		
			AT22LV10-25KM/883	28KW		
			AT22LV10-25LM/883	28LW		
			AT22LV10-25NM/883	28L		
AT22LV10-25YM/883	24CW					
30	15	20	AT22LV10-30DC	24DW3	Commercial (0°C to 70°C)	
			AT22LV10-30FC	24C		
			AT22LV10-30GC	24D3		
			AT22LV10-30JC	28J		
			AT22LV10-30KC	28KW		
			AT22LV10-30LC	28LW		
			AT22LV10-30NC	28L		
			AT22LV10-30PC	24P3		
			AT22LV10-30SC	24S		
			AT22LV10-30YC	24CW		
			AT22LV10-30DI	24DW3		Industrial (-40°C to 85°C)
			AT22LV10-30FI	24C		
			AT22LV10-30GI	24D3		
			AT22LV10-30JI	28J		
			AT22LV10-30KI	28KW		
AT22LV10-30LI	28LW					
AT22LV10-30NI	28L					
AT22LV10-30PI	24P3					
AT22LV10-30SI	24S					
AT22LV10-30YI	24CW					

Ordering Information

tpd (ns)	ts (ns)	tco (ns)	Ordering Code	Package	Operation Range
30	15	20	AT22LV10-30DM AT22LV10-30FM AT22LV10-30GM AT22LV10-30KM AT22LV10-30LM AT22LV10-30NM AT22LV10-30YM	24DW3 24C 28D3 28KW 28LW 28L 24CW	Military (-55°C to 125°C)
			AT22LV10-30DM/883 AT22LV10-30FM/883 AT22LV10-30GM/883 AT22LV10-30KM/883 AT22LV10-30LM/883 AT22LV10-30NM/883 AT22LV10-30YM/883	24DW3 24C 24D3 28KW 28LW 28L 24CW	Military/883D (-55°C to 125°C) Class B, Fully Compliant

Package Type	
24DW3	24 Lead, 0.300" Wide, Windowed, Ceramic Dual Inline Package (Cerdip)
24C	24 Lead, Non-Windowed, Ceramic Flat Package (Cerpack)
24D3	24 Lead, 0.300" Wide, Non-Windowed (OTP), Ceramic Dual Inline Package (Cerdip)
28J	28 Lead, Plastic J-Leaded Chip Carrier OTP (PLCC)
28KW	28 Lead, Windowed, Ceramic J-Leaded Chip Carrier (JLCC)
28LW	28 Pad, Windowed, Ceramic Leadless Chip Carrier (LCC)
28L	28 Pad, Non-Windowed, Ceramic Leadless Chip Carrier OTP (LCC)
24P3	24 Lead, 0.300" Wide, Plastic Dual Inline Package OTP (PDIP)
24S	24 Lead, 0.300" Wide, Plastic Gull Wing Small Outline OTP (SOIC)
24CW	24 Lead, Windowed, Ceramic Flat Package (Cerpack)



Ordering Information

tpd (ns)	ts (ns)	tco (ns)	Ordering Code	Package	Operation Range	
25	17	14	AT22LV10L-25DC	24DW3	Commercial (0°C to 70°C)	
			AT22LV10L-25FC	24C		
			AT22LV10L-25GC	24D3		
			AT22LV10L-25JC	28J		
			AT22LV10L-25KC	28KW		
			AT22LV10L-25LC	28LW		
			AT22LV10L-25NC	28L		
			AT22LV10L-25PC	24P3		
			AT22LV10L-25SC	24S		
			AT22LV10L-25YC	24CW		
			AT22LV10L-25DI	24DW3		Industrial (-40°C to 85°C)
			AT22LV10L-25FI	24C		
			AT22LV10L-25GI	24D3		
			AT22LV10L-25JI	28J		
			AT22LV10L-25KI	28KW		
			AT22LV10L-25LI	28LW		
			AT22LV10L-25NI	28L		
			AT22LV10L-25PI	24P3		
			AT22LV10L-25SI	24S		
AT22LV10L-25YI	24CW					
30	20	17	AT22LV10L-30DC	24DW3	Commercial (0°C to 70°C)	
			AT22LV10L-30FC	24C		
			AT22LV10L-30GC	24D3		
			AT22LV10L-30JC	28J		
			AT22LV10L-30KC	28KW		
			AT22LV10L-30LC	28LW		
			AT22LV10L-30NC	28L		
			AT22LV10L-30PC	24P3		
			AT22LV10L-30SC	24S		
			AT22LV10L-30YC	24CW		
			AT22LV10L-30DI	24DW3		Industrial (-40°C to 85°C)
			AT22LV10L-30FI	24C		
			AT22LV10L-30GI	24D3		
			AT22LV10L-30JI	28J		
			AT22LV10L-30KI	28KW		
			AT22LV10L-30LI	28LW		
			AT22LV10L-30NI	28L		
			AT22LV10L-30PI	24P3		
			AT22LV10L-30SI	24S		
			AT22LV10L-30YI	24CW		
			AT22LV10L-30DM	24DW3	Military (-55°C to 125°C)	
			AT22LV10L-30FM	24C		
			AT22LV10L-30GM	24D3		
			AT22LV10L-30KM	28KW		
			AT22LV10L-30LM	28LW		
			AT22LV10L-30NM	28L		
			AT22LV10L-30YM	24CW		

Ordering Information

tpd (ns)	ts (ns)	tco (ns)	Ordering Code	Package	Operation Range
30	20	17	AT22LV10L-30DM/883	24DW3	Military/883D (-55°C to 125°C) Class B, Fully Compliant
			AT22LV10L-30FM/883	24C	
			AT22LV10L-30GM/883	24D3	
			AT22LV10L-30KM/883	28KW	
			AT22LV10L-30LM/883	28LW	
			AT22LV10L-30NM/883	28L	
			AT22LV10L-30YM/883	24CW	
35	22	20	AT22LV10L-35DC	24DW3	Commercial (0°C to 70°C)
			AT22LV10L-35FC	24C	
			AT22LV10L-35GC	24D3	
			AT22LV10L-35JC	28J	
			AT22LV10L-35KC	28KW	
			AT22LV10L-35LC	28LW	
			AT22LV10L-35NC	28L	
			AT22LV10L-35PC	24P3	
			AT22LV10L-35SC	24S	
			AT22LV10L-35YC	24CW	
			AT22LV10L-35DI	24DW3	Industrial (-40°C to 85°C)
			AT22LV10L-35FI	24C	
			AT22LV10L-35GI	24D3	
			AT22LV10L-35JI	28J	
			AT22LV10L-35KI	28KW	
			AT22LV10L-35LI	28LW	
			AT22LV10L-35NI	28L	
			AT22LV10L-35PI	24P3	
			AT22LV10L-35SI	24S	
			AT22LV10L-35YI	24CW	
			AT22LV10L-35DM	24DW3	Military (-55°C to 125°C)
			AT22LV10L-35FM	24C	
			AT22LV10L-35GM	28D3	
			AT22LV10L-35KM	28KW	
AT22LV10L-35LM	28LW				
AT22LV10L-35NM	28L				
AT22LV10L-35YM	24CW				
AT22LV10L-35DM/883	24DW3	Military/883D (-55°C to 125°C) Class B, Fully Compliant			
AT22LV10L-35FM/883	24C				
AT22LV10L-35GM/883	24D3				
AT22LV10L-35KM/883	28KW				
AT22LV10L-35LM/883	28LW				
AT22LV10L-35NM/883	28L				
AT22LV10L-35YM/883	24CW				



Package Type	
24DW3	24 Lead, 0.300" Wide, Windowed, Ceramic Dual Inline Package (Cerdip)
24C	24 Lead, Non-Windowed, Ceramic Flat Package (Cerpack)
24D3	24 Lead, 0.300" Wide, Non-Windowed (OTP), Ceramic Dual Inline Package (Cerdip)
28J	28 Lead, Plastic J-Leaded Chip Carrier OTP (PLCC)
28KW	28 Lead, Windowed, Ceramic J-Leaded Chip Carrier (JLCC)
28LW	28 Pad, Windowed, Ceramic Leadless Chip Carrier (LCC)
28L	28 Pad, Non-Windowed, Ceramic Leadless Chip Carrier OTP (LCC)
24P3	24 Lead, 0.300" Wide, Plastic Dual Inline Package OTP (PDIP)
24S	24 Lead, 0.300" Wide, Plastic Gull Wing Small Outline OTP (SOIC)
24CW	24 Lead, Windowed, Ceramic Flat Package (Cerpack)