

SN74LS42

One-of-Ten Decoder

The LSTTL/MSI SN74LS42 is a Multipurpose Decoder designed to accept four BCD inputs and provide ten mutually exclusive outputs. The LS42 is fabricated with the Schottky barrier diode process for high speed and is completely compatible with all ON Semiconductor TTL families.

- Multifunction Capability
- Mutually Exclusive Outputs
- Demultiplexing Capability
- Input Clamp Diodes Limit High Speed Termination Effects

GUARANTEED OPERATING RANGES

Symbol	Parameter	Min	Typ	Max	Unit
V _{CC}	Supply Voltage	4.75	5.0	5.25	V
T _A	Operating Ambient Temperature Range	0	25	70	°C
I _{OH}	Output Current – High			-0.4	mA
I _{OL}	Output Current – Low			8.0	mA



ON Semiconductor™

<http://onsemi.com>

**LOW
POWER
SCHOTTKY**

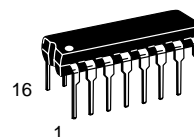

**PLASTIC
N SUFFIX
CASE 648**

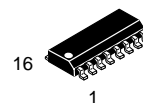

**SOIC
D SUFFIX
CASE 751B**

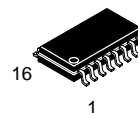

**SOEIAJ
M SUFFIX
CASE 966**

ORDERING INFORMATION

Device	Package	Shipping
SN74LS42N	16 Pin DIP	2000 Units/Box
SN74LS42D	SOIC-16	38 Units/Rail
SN74LS42DR2	SOIC-16	2500/Tape & Reel
SN74LS42M	SOEIAJ-16	See Note 1
SN74LS42MEL	SOEIAJ-16	See Note 1

1. For ordering information on the EIAJ version of the SOIC package, please contact your local ON Semiconductor representative.

SN74LS42

CONNECTION DIAGRAM DIP (TOP VIEW)

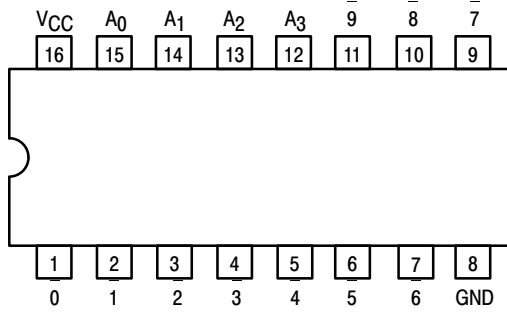

NOTE:
The Flatpak version
has the same pinouts
(Connection Diagram)
as the Dual In-Line
Package.

PIN NAMES

A₀ - A₃ Address Inputs
0 to 9 Outputs, Active LOW

LOADING (Note a)

HIGH	LOW
0.5 U.L.	0.25 U.L.
10 U.L.	5 U.L.

NOTES:

a) 1 TTL Unit Load (U.L.) = 40 μ A HIGH/1.6 mA LOW.

LOGIC SYMBOL

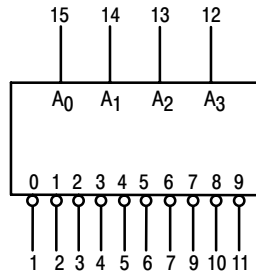

V_{CC} = PIN 16
GND = PIN 8

LOGIC DIAGRAM

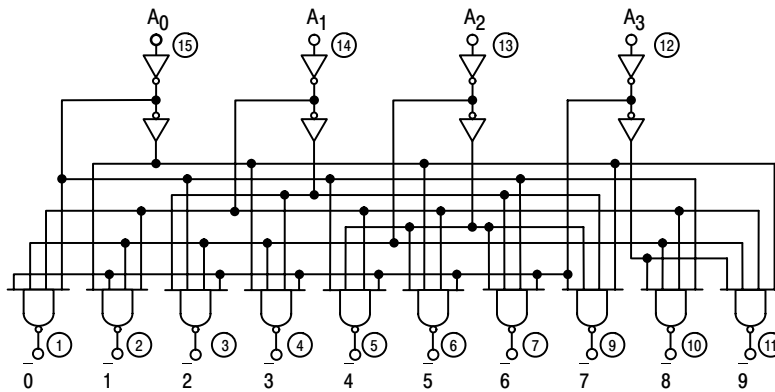

V_{CC} = PIN 16

GND = PIN 8

○ = PIN NUMBERS

SN74LS42

FUNCTIONAL DESCRIPTION

The LS42 decoder accepts four active HIGH BCD inputs and provides ten mutually exclusive active LOW outputs, as shown by logic symbol or diagram. The active LOW outputs facilitate addressing other MSI units with LOW input enables.

The logic design of the LS42 ensures that all outputs are HIGH when binary codes greater than nine are applied to the inputs.

The most significant input A₃ produces a useful inhibit function when the LS42 is used as a one-of-eight decoder. The A₃ input can also be used as the Data input in an 8-output demultiplexer application.

TRUTH TABLE

A ₀	A ₁	A ₂	A ₃	0	1	2	3	4	5	6	7	8	9
L	L	L	L	L	H	H	H	H	H	H	H	H	H
H	L	L	L	H	L	H	H	H	H	H	H	H	H
L	H	L	L	H	H	L	H	H	H	H	H	H	H
H	H	L	L	H	H	H	L	H	H	H	H	H	H
L	L	H	L	H	H	H	H	L	H	H	H	H	H
H	L	H	L	H	H	H	H	H	L	H	H	H	H
L	H	H	L	H	H	H	H	H	H	L	H	H	H
H	H	H	L	H	H	H	H	H	H	H	L	H	H
L	L	L	H	H	H	H	H	H	H	H	H	L	H
H	L	L	H	H	H	H	H	H	H	H	H	H	L
L	H	L	H	H	H	H	H	H	H	H	H	H	H
H	H	L	H	H	H	H	H	H	H	H	H	H	H
L	L	H	H	H	H	H	H	H	H	H	H	H	H
H	L	H	H	H	H	H	H	H	H	H	H	H	H
L	H	H	H	H	H	H	H	H	H	H	H	H	H
H	H	H	H	H	H	H	H	H	H	H	H	H	H

H = HIGH Voltage Level
L = LOW Voltage Level

SN74LS42

DC CHARACTERISTICS OVER OPERATING TEMPERATURE RANGE (unless otherwise specified)

Symbol	Parameter	Limits			Unit	Test Conditions
		Min	Typ	Max		
V _{IH}	Input HIGH Voltage	2.0			V	Guaranteed Input HIGH Voltage for All Inputs
V _{IL}	Input LOW Voltage			0.8	V	Guaranteed Input LOW Voltage for All Inputs
V _{IK}	Input Clamp Diode Voltage		-0.65	-1.5	V	V _{CC} = MIN, I _{IN} = -18 mA
V _{OH}	Output HIGH Voltage	2.7	3.5		V	V _{CC} = MIN, I _{OH} = MAX, V _{IN} = V _{IH} or V _{IL} per Truth Table
V _{OL}	Output LOW Voltage		0.25	0.4	V	V _{CC} = V _{CC} MIN, V _{IN} = V _{IL} or V _{IH} per Truth Table
			0.35	0.5	V	
I _{IH}	Input HIGH Current			20	μA	V _{CC} = MAX, V _{IN} = 2.7 V
				0.1	mA	V _{CC} = MAX, V _{IN} = 7.0 V
I _{IL}	Input LOW Current			-0.4	mA	V _{CC} = MAX, V _{IN} = 0.4 V
I _{OS}	Short Circuit Current (Note 2)	-20		-100	mA	V _{CC} = MAX
I _{CC}	Power Supply Current			13	mA	V _{CC} = MAX

2. Not more than one output should be shorted at a time, nor for more than 1 second.

AC CHARACTERISTICS (T_A = 25°C)

Symbol	Parameter	Limits			Unit	Test Conditions	
		Min	Typ	Max			
t _{PLH} t _{PHL}	Propagation Delay (2 Levels)		15 15	25 25	ns	Figure 2	V _{CC} = 5.0 V C _L = 15 pF
t _{PLH} t _{PHL}	Propagation Delay (3 Levels)		20 20	30 30	ns	Figure 1	

AC WAVEFORMS

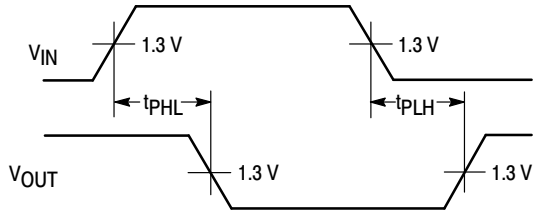

Figure 1.

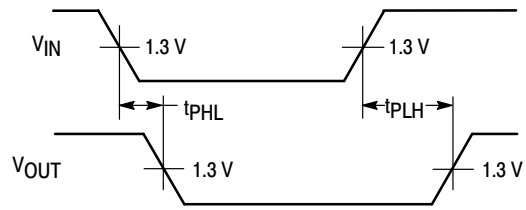
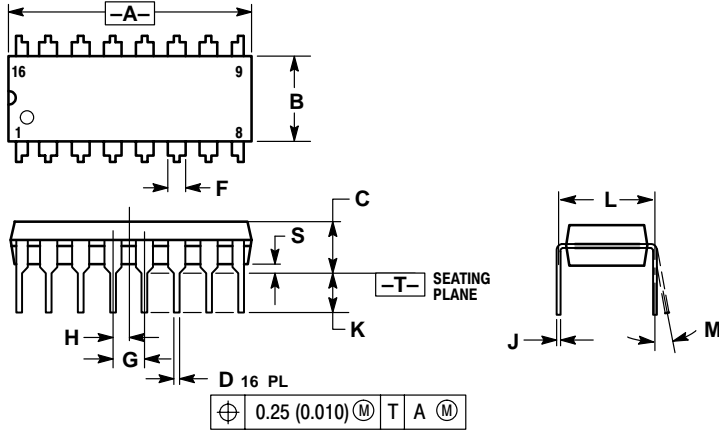

Figure 2.

SN74LS42

PACKAGE DIMENSIONS

N SUFFIX
PLASTIC PACKAGE
CASE 648-08
ISSUE R



NOTES:

1. DIMENSIONING AND TOLERANCING PER ANSI Y14.5M, 1982.
2. CONTROLLING DIMENSION: INCH.
3. DIMENSION L TO CENTER OF LEADS WHEN FORMED PARALLEL.
4. DIMENSION B DOES NOT INCLUDE MOLD FLASH.
5. ROUNDED CORNERS OPTIONAL.

DIM	INCHES		MILLIMETERS	
	MIN	MAX	MIN	MAX
A	0.740	0.770	18.80	19.55
B	0.250	0.270	6.35	6.85
C	0.145	0.175	3.69	4.44
D	0.015	0.021	0.39	0.53
F	0.040	0.70	1.02	1.77
G	0.100 BSC		2.54 BSC	
H	0.050 BSC		1.27 BSC	
J	0.008	0.015	0.21	0.38
K	0.110	0.130	2.80	3.30
L	0.295	0.305	7.50	7.74
M	0° 10°		0° 10°	
S	0.020	0.040	0.51	1.01

SN74LS42

PACKAGE DIMENSIONS

D SUFFIX PLASTIC SOIC PACKAGE CASE 751B-05 ISSUE J

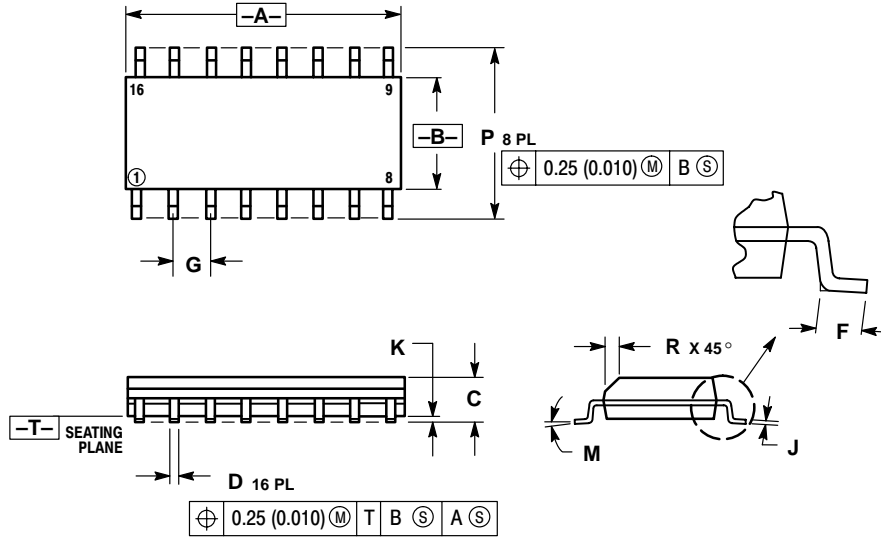

- NOTES:
1. DIMENSIONING AND TOLERANCING PER ANSI Y14.5M, 1982.
 2. CONTROLLING DIMENSION: MILLIMETER.
 3. DIMENSIONS A AND B DO NOT INCLUDE MOLD PROTRUSION.
 4. MAXIMUM MOLD PROTRUSION 0.15 (0.006) PER SIDE.
 5. DIMENSION D DOES NOT INCLUDE DAMBAR PROTRUSION. ALLOWABLE DAMBAR PROTRUSION SHALL BE 0.127 (0.005) TOTAL IN EXCESS OF THE D DIMENSION AT MAXIMUM MATERIAL CONDITION.

DIM	MILLIMETERS		INCHES	
	MIN	MAX	MIN	MAX
A	9.80	10.00	0.386	0.393
B	3.80	4.00	0.150	0.157
C	1.35	1.75	0.054	0.068
D	0.35	0.49	0.014	0.019
F	0.40	1.25	0.016	0.049
G	1.27 BSC		0.050 BSC	
J	0.19	0.25	0.008	0.009
K	0.10	0.25	0.004	0.009
M	0° 7°		0° 7°	
P	5.80	6.20	0.229	0.244
R	0.25	0.50	0.010	0.019

SN74LS42

PACKAGE DIMENSIONS

M SUFFIX
SOEIAJ PACKAGE
CASE 966-01
ISSUE O

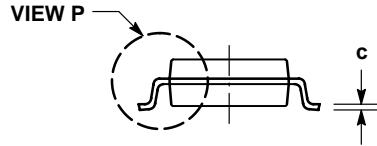
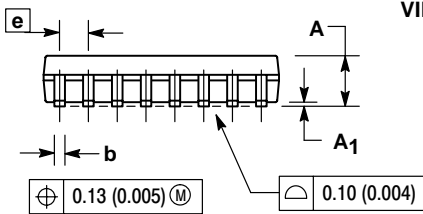
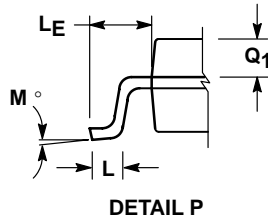
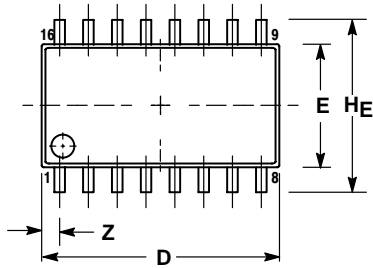

NOTES:

1. DIMENSIONING AND TOLERANCING PER ANSI Y14.5M, 1982.
2. CONTROLLING DIMENSION: MILLIMETER.
3. DIMENSIONS D AND E DO NOT INCLUDE MOLD FLASH OR PROTRUSIONS AND ARE MEASURED AT THE PARTING LINE. MOLD FLASH OR PROTRUSIONS SHALL NOT EXCEED 0.15 (0.006) PER SIDE.
4. TERMINAL NUMBERS ARE SHOWN FOR REFERENCE ONLY.
5. THE LEAD WIDTH DIMENSION (b) DOES NOT INCLUDE DAMBAR PROTRUSION. ALLOWABLE DAMBAR PROTRUSION SHALL BE 0.08 (0.003) TOTAL IN EXCESS OF THE LEAD WIDTH DIMENSION AT MAXIMUM MATERIAL CONDITION. DAMBAR CANNOT BE LOCATED ON THE LOWER RADIUS OR THE FOOT. MINIMUM SPACE BETWEEN PROTRUSIONS AND ADJACENT LEAD TO BE 0.46 (0.018).

DIM	MILLIMETERS		INCHES	
	MIN	MAX	MIN	MAX
A	---	2.05	---	0.081
A ₁	0.05	0.20	0.002	0.008
b	0.35	0.50	0.014	0.020
c	0.18	0.27	0.007	0.011
D	9.90	10.50	0.390	0.413
E	5.10	5.45	0.201	0.215
e	1.27 BSC		0.050 BSC	
HE	7.40	8.20	0.291	0.323
L	0.50	0.85	0.020	0.033
LE	1.10	1.50	0.043	0.059
M	0° 10°		0° 10°	
Q ₁	0.70	0.90	0.028	0.035
Z	---	0.78	---	0.031

SN74LS42

ON Semiconductor and  are trademarks of Semiconductor Components Industries, LLC (SCILLC). SCILLC reserves the right to make changes without further notice to any products herein. SCILLC makes no warranty, representation or guarantee regarding the suitability of its products for any particular purpose, nor does SCILLC assume any liability arising out of the application or use of any product or circuit, and specifically disclaims any and all liability, including without limitation special, consequential or incidental damages. "Typical" parameters which may be provided in SCILLC data sheets and/or specifications can and do vary in different applications and actual performance may vary over time. All operating parameters, including "Typicals" must be validated for each customer application by customer's technical experts. SCILLC does not convey any license under its patent rights nor the rights of others. SCILLC products are not designed, intended, or authorized for use as components in systems intended for surgical implant into the body, or other applications intended to support or sustain life, or for any other application in which the failure of the SCILLC product could create a situation where personal injury or death may occur. Should Buyer purchase or use SCILLC products for any such unintended or unauthorized application, Buyer shall indemnify and hold SCILLC and its officers, employees, subsidiaries, affiliates, and distributors harmless against all claims, costs, damages, and expenses, and reasonable attorney fees arising out of, directly or indirectly, any claim of personal injury or death associated with such unintended or unauthorized use, even if such claim alleges that SCILLC was negligent regarding the design or manufacture of the part. SCILLC is an Equal Opportunity/Affirmative Action Employer.

PUBLICATION ORDERING INFORMATION

Literature Fulfillment:

Literature Distribution Center for ON Semiconductor
P.O. Box 5163, Denver, Colorado 80217 USA
Phone: 303-675-2175 or 800-344-3860 Toll Free USA/Canada
Fax: 303-675-2176 or 800-344-3867 Toll Free USA/Canada
Email: ONlit@hibbertco.com

N. American Technical Support: 800-282-9855 Toll Free USA/Canada

JAPAN: ON Semiconductor, Japan Customer Focus Center
4-32-1 Nishi-Gotanda, Shinagawa-ku, Tokyo, Japan 141-0031
Phone: 81-3-5740-2700
Email: r14525@onsemi.com

ON Semiconductor Website: <http://onsemi.com>

For additional information, please contact your local Sales Representative.