

Hyperfast Rectifier, 15 A FRED Pt®

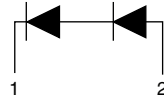

2L TO-220 FULL-PAK



FEATURES

- Hyperfast recovery time, extremely low Q_{rr}
- 175 °C maximum operating junction temperature
- High frequency PFC CCM operation
- Low leakage current
- Halogen-free according to IEC 61249-2-21 definition
- Designed and qualified for industrial level



DESCRIPTION

VS-15S2TH06FP 600 V series are the state of the art tandem hyperfast recovery rectifiers: excellent switching performance and extremely low forward voltage drop trade off is overcome, boosting overall application performance. Specially designed for CCM PFC application, these devices show incomparable performance in every current intensive hard switching application.

Optimized reverse recovery stored charge enables downsizing of boosting switch and cooling system, increased operating frequency make possible use of smaller reactive elements. Cost effective PFC application is then possible with high efficiency over wide input voltage range and loading factor.

Plastic insulated package features easy mounting together with not insulated parts.

PRODUCT SUMMARY

Package	2L TO-220FP
$I_{F(AV)}$	15 A
V_R	600 V
V_F at I_F	2.4 V
t_{rr} (typ.)	See Recovery table
T_J max.	175 °C
Diode variation	Doubler

ABSOLUTE MAXIMUM RATINGS FOR BOTH DIODES

PARAMETER	SYMBOL	TEST CONDITIONS	MAX.	UNITS
Repetitive peak reverse voltage	V_{RRM}		600	V
DC forward current	I_F	$T_C = 73\text{ °C}$	15	A
Non-repetitive peak surge current	I_{FSM}	$T_C = 25\text{ °C}$	115	
Operating junction and storage temperatures	T_J, T_{Stg}		- 55 to 175	°C

ELECTRICAL SPECIFICATIONS FOR BOTH DIODES ($T_J = 25\text{ °C}$ unless otherwise specified)

PARAMETER	SYMBOL	TEST CONDITIONS	MIN.	TYP.	MAX.	UNITS
Breakdown voltage, blocking voltage	V_{BR}, V_R	$I_R = 100\ \mu\text{A}$	600	-	-	V
Forward voltage	V_F	$I_F = 15\text{ A}$	-	2.2	2.4	
		$I_F = 15\text{ A}, T_J = 125\text{ °C}$	-	1.9	2.1	
		$I_F = 15\text{ A}, T_J = 150\text{ °C}$	-	1.8	2	
Reverse leakage current	I_R	$V_R = V_R$ rated	-	< 1	10	μA
		$T_J = 125\text{ °C}, V_R = V_R$ rated	-	10	100	
		$T_J = 150\text{ °C}, V_R = V_R$ rated	-	40	200	
Junction capacitance	C_T	$V_R = 600\text{ V}$	-	17	-	pF

DYNAMIC RECOVERY CHARACTERISTICS FOR BOTH DIODES ($T_J = 25\text{ °C}$ unless otherwise specified)							
PARAMETER	SYMBOL	TEST CONDITIONS	MIN.	TYP.	MAX.	UNITS	
Reverse recovery time	t_{rr}	$I_F = 1.0\text{ A}$, $di_F/dt = -50\text{ A}/\mu\text{s}$, $V_R = 30\text{ V}$	-	-	28	ns	
		$T_J = 25\text{ °C}$	-	20	-		
		$T_J = 125\text{ °C}$	-	45	-		
Peak recovery current	I_{RRM}	$I_F = 15\text{ A}$ $di_F/dt = -200\text{ A}/\mu\text{s}$ $V_R = 390\text{ V}$	$T_J = 25\text{ °C}$	-	2.6	-	A
			$T_J = 125\text{ °C}$	-	5.6	6.5	
Reverse recovery charge	Q_{rr}	$T_J = 25\text{ °C}$	$T_J = 25\text{ °C}$	-	28	-	nC
			$T_J = 125\text{ °C}$	-	140	-	

THERMAL - MECHANICAL SPECIFICATIONS FOR BOTH DIODES						
PARAMETER	SYMBOL	TEST CONDITIONS	MIN.	TYP.	MAX.	UNITS
Maximum junction and storage temperature range	T_J, T_{Stg}		- 55	-	175	°C
Thermal resistance, junction to case	R_{thJC}		-	-	3.9	°C/W
Thermal resistance, case to heatsink	R_{thCS}	Mounting surface, flat, smooth and greased	-	0.2	-	
Weight			-	2.0	-	g
			-	0.07	-	oz.
Mounting torque			6.0 (5.0)	-	12 (10)	kgf · cm (lbf · in)
Marking device		Case style 2L TO-220 FULL-PAK	15S2TH06FP			

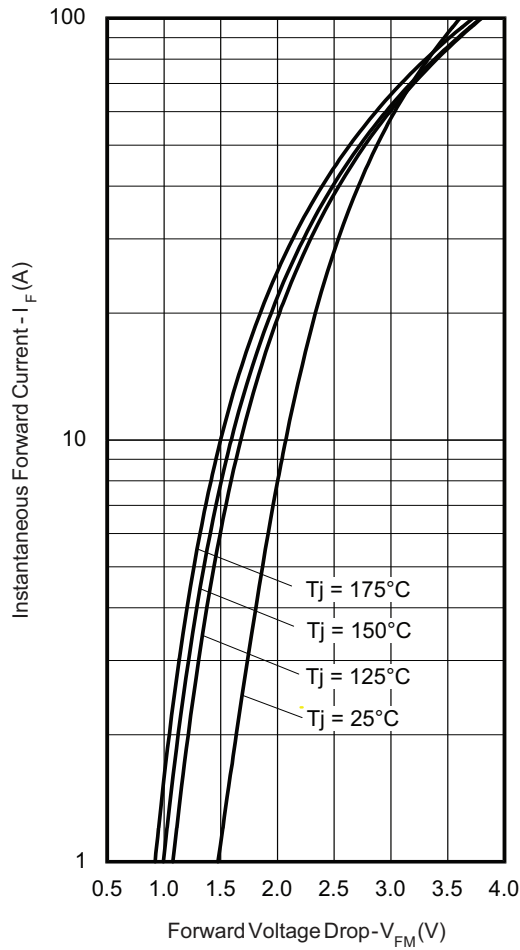

Fig. 1 - Maximum Forward Voltage Drop Characteristics

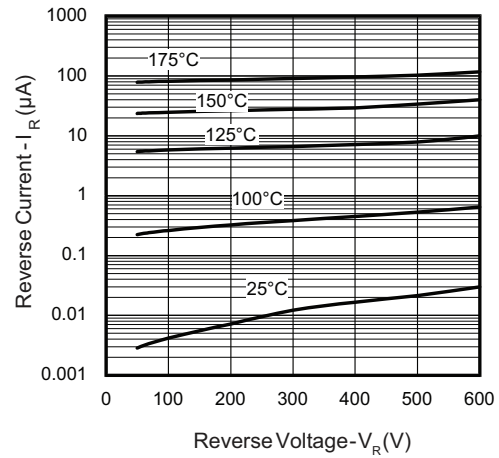

Fig. 2 - Typical Values of Reverse Current vs. Reverse Voltage

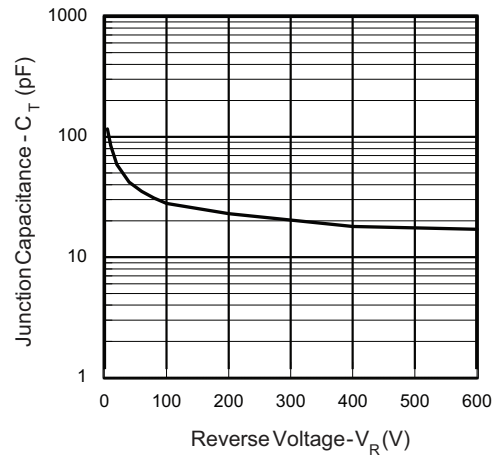
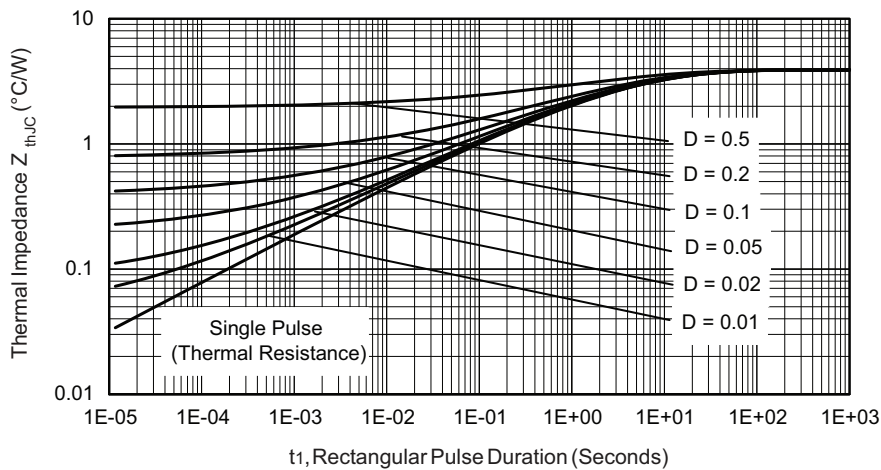

Fig. 3 - Typical Junction Capacitance vs. Reverse Voltage

 Fig. 4 - Maximum Thermal Impedance Z_{thJC} Characteristics

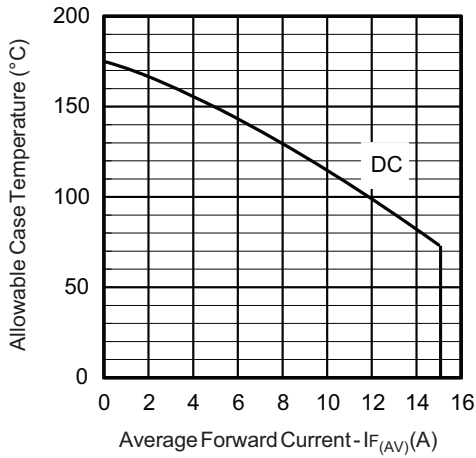

Fig. 5 - Maximum Allowable Case Temperature vs. Average Forward Current

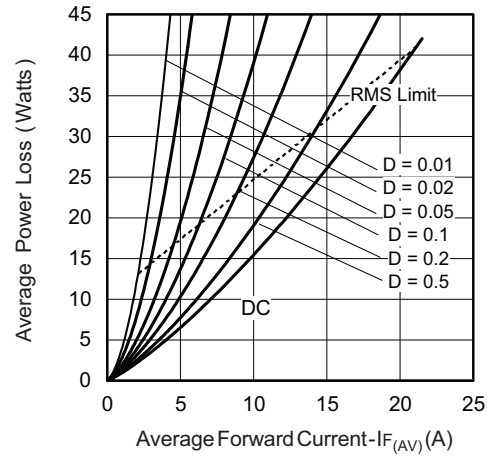

Fig. 6 - Forward Power Loss Characteristics

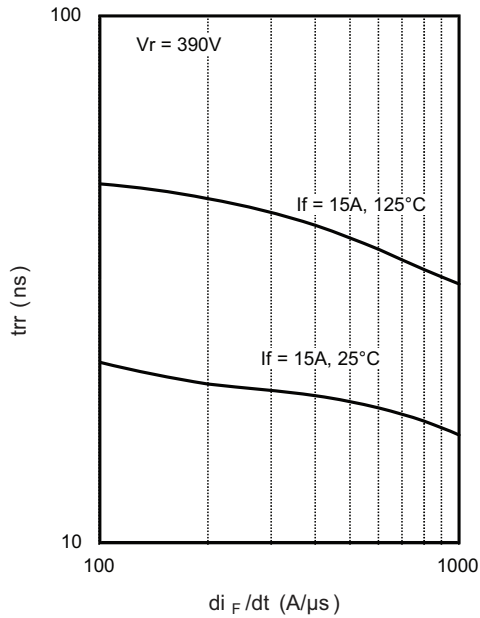

Fig. 7 - Typical Reverse Recovery Time vs. di_F/dt

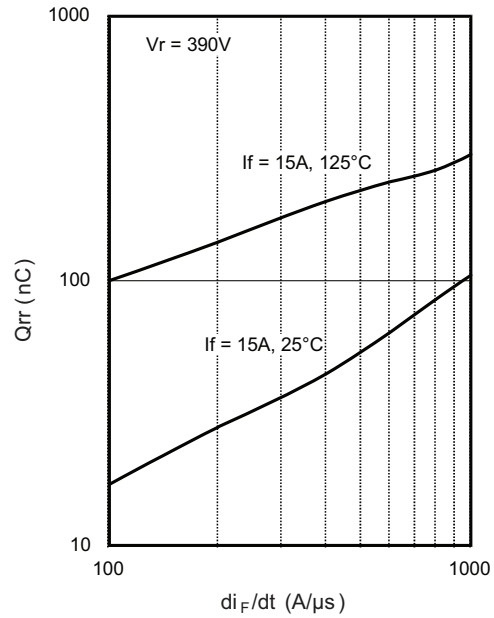
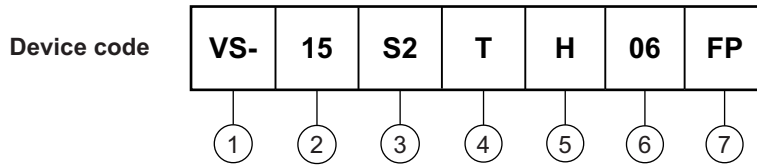

Fig. 8 - Typical Stored Charge vs. di_F/dt



ORDERING INFORMATION TABLE



- 1** - Vishay Semiconductors product suffix
- 2** - Current rating (15 = 15 A)
- 3** - S2 = Doubler true 2 pin
- 4** - T = TO-220
- 5** - H = Hyperfast recovery
- 6** - Voltage rating (06 = 600 V)
- 7** - FP = TO-220 FULL-PAK

LINKS TO RELATED DOCUMENTS	
Dimensions	www.vishay.com/doc?95263
Part marking information	www.vishay.com/doc?95265

TO-220 (2 PIN) FULL-PAK Tandem

DIMENSIONS in millimeters

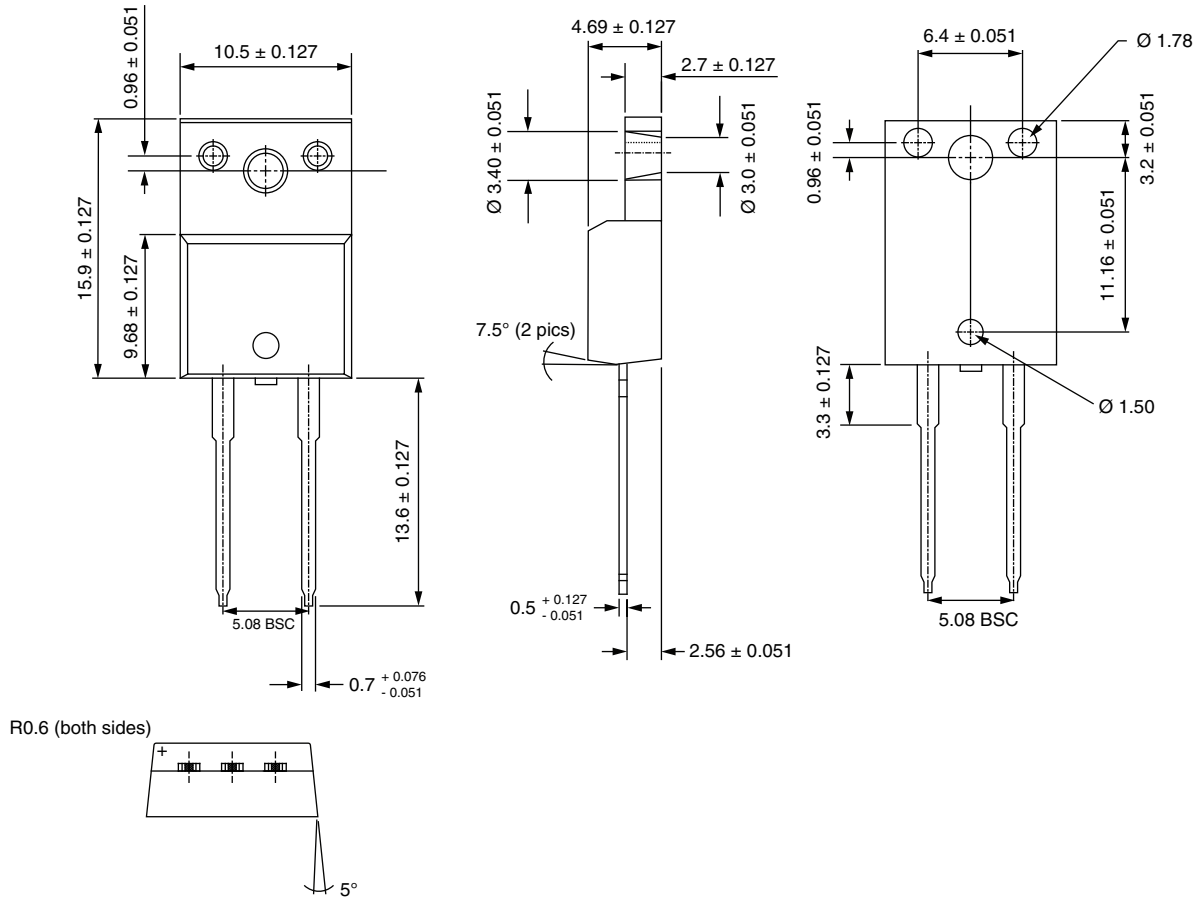



Disclaimer

ALL PRODUCT, PRODUCT SPECIFICATIONS AND DATA ARE SUBJECT TO CHANGE WITHOUT NOTICE TO IMPROVE RELIABILITY, FUNCTION OR DESIGN OR OTHERWISE.

Vishay Intertechnology, Inc., its affiliates, agents, and employees, and all persons acting on its or their behalf (collectively, "Vishay"), disclaim any and all liability for any errors, inaccuracies or incompleteness contained in any datasheet or in any other disclosure relating to any product.

Vishay makes no warranty, representation or guarantee regarding the suitability of the products for any particular purpose or the continuing production of any product. To the maximum extent permitted by applicable law, Vishay disclaims (i) any and all liability arising out of the application or use of any product, (ii) any and all liability, including without limitation special, consequential or incidental damages, and (iii) any and all implied warranties, including warranties of fitness for particular purpose, non-infringement and merchantability.

Statements regarding the suitability of products for certain types of applications are based on Vishay's knowledge of typical requirements that are often placed on Vishay products in generic applications. Such statements are not binding statements about the suitability of products for a particular application. It is the customer's responsibility to validate that a particular product with the properties described in the product specification is suitable for use in a particular application. Parameters provided in datasheets and/or specifications may vary in different applications and performance may vary over time. All operating parameters, including typical parameters, must be validated for each customer application by the customer's technical experts. Product specifications do not expand or otherwise modify Vishay's terms and conditions of purchase, including but not limited to the warranty expressed therein.

Except as expressly indicated in writing, Vishay products are not designed for use in medical, life-saving, or life-sustaining applications or for any other application in which the failure of the Vishay product could result in personal injury or death. Customers using or selling Vishay products not expressly indicated for use in such applications do so at their own risk and agree to fully indemnify and hold Vishay and its distributors harmless from and against any and all claims, liabilities, expenses and damages arising or resulting in connection with such use or sale, including attorneys fees, even if such claim alleges that Vishay or its distributor was negligent regarding the design or manufacture of the part. Please contact authorized Vishay personnel to obtain written terms and conditions regarding products designed for such applications.

No license, express or implied, by estoppel or otherwise, to any intellectual property rights is granted by this document or by any conduct of Vishay. Product names and markings noted herein may be trademarks of their respective owners.