

**DATA SHEET**

# SKY65051-377LF: 0.45-6.0 GHz Low Noise Transistor

## Applications

- Wireless infrastructure: WLAN, WiMAX, broadband, cellular base stations
- Test instrumentation
- LNA for GPS receivers
- Satellite receivers

## Features

- Externally matched for wideband operation
- Noise Figure = 0.45 dB @ 2.4 GHz of device only
- Noise Figure = 0.65 dB @ 2.4 GHz including matching network loss
- Gain = 15.5 dB @ 2.4 GHz
- OIP3 = +24 dBm @ 2.4 GHz
- P1dB = +12 dBm @ 2.4 GHz
- Adjustable supply current from 5 to 55 mA
- Small, QFN (4-pin, 2 x 2 mm) Pb-free package (MSL1, 260 °C per JEDEC J-STD-020)

**NEW**



Skyworks Green™ products are RoHS (Restriction of Hazardous Substances)-compliant, conform to the EIA/EICTA/JEITA Joint Industry Guide (JIG) Level A guidelines, are halogen free according to IEC-61249-2-21, and contain <1,000 ppm antimony trioxide in polymeric materials.

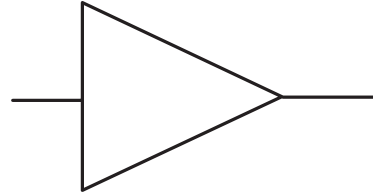

**Figure 1. SKY65051-377LF Block Diagram**

## Description

The SKY65051-377LF is a high performance, n-channel low-noise transistor. The device is fabricated from Skyworks advanced depletion mode pHEMT process and is provided in a 2 x 2 mm, 4-pin Quad Flat No-Lead (QFN) package.

The transistor's low Noise Figure (NF), high gain, and excellent 3<sup>rd</sup> Order Intercept Point (IP3) allow the device to be used in various receiver and transmitter applications.

A functional block diagram is shown in Figure 1. The pin configuration and package are shown in Figure 2. Signal pin assignments and functional pin descriptions are provided in Table 1.

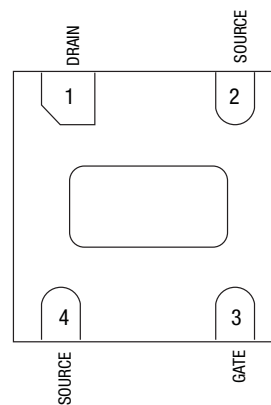

**Figure 2. SKY65051-377LF Pinout – 4-Pin QFN (Bottom View)**

**Table 1. SKY65051-377LF Signal Descriptions**

Pin #	Name	Description	Pin #	Name	Description
1	DRAIN	RF output. Requires external matching network for optimum performance. Supply voltage required through external RF choke.	3	GATE	RF input. Requires external matching network for optimum performance.
2	SOURCE	Source lead. Provides DC self-biasing point and AC ground.	4	SOURCE	Source lead. Provides DC self-biasing point and AC ground.

**Table 2. Self-Biasing Resistors**

Resistor Value ( $\Omega$ )	Drain Current (mA)
130	5
47	10
27	15
20	20
15	25
10	30

**Functional Description**

The SKY65051-377LF is a depletion mode pHEMT designed for low noise, high frequency applications. The SKY65051-377LF has a typical NF of 0.65 dB tested at the 2.4 GHz wireless LAN frequency band. A gain of 15.5 dB typical is achieved using the same circuit. If the frequency of operation is lowered to the 1 GHz range, NF performance of the device can approach 0.5 dB including input matching network losses.

De-embedded scattering and noise parameters are provided in addition to typical circuit topologies for commonly used frequency bands. With an appropriate circuit, the SKY65051-377LF can be used for many applications from 450 MHz up to 6 GHz. The 2 x 2 mm QFN package makes the SKY65051-377LF an ideal low noise and low cost solution.

**Biasing**

To properly bias a depletion mode pHEMT, both the gate and drain of the device must be properly biased. At  $V_{GS} = 0\text{ V}$  and  $V_{DS} \geq 2\text{ V}$ , the device is in a saturated state and draws the maximum amount of current,  $I_{DSS}$ . The device typically achieves the best noise performance at  $V_{DS} = 3\text{ V}$  and  $I_{DSS} = 15\text{ mA}$ . To control  $I_{DS}$ ,  $V_{GS}$  must be biased with a negative voltage supply.

To eliminate the need for a negative DC supply, self-biasing should be used when a resistor is placed between one of the source leads and ground. A bypass capacitor should be placed in parallel to this resistor to provide an RF ground and to ensure performance remains unchanged at the operating frequency.

When current flows from drain to source and through the resistor, the source voltage becomes biased above DC ground. The gate pin of the device should be left unbiased at 0 V, which creates the

desired negative  $V_{GS}$  value. This simplifies the design by eliminating the need for a second DC supply.

Table 2 provides the resistor values used to properly bias the SKY65051-377LF.

**RF Matching Networks**

The SKY65051-377LF Evaluation Board assembly diagram is shown in Figure 12 and a circuit schematic is provided in Figure 13. The schematic shows the recommended RF matching network used for the 2.4 GHz wireless LAN frequency band. The network was designed using de-embedded s- and n-parameters. The circuit was primarily tuned for gain, NF, and input and output return loss, while maintaining proper stability.

Optimal noise performance is attained when the impedance presented to the input of the amplifier is equal to its minimum NF impedance point. Components C1, C2, C3, L1, and L2 shown in Figures 12 and 13 provide the necessary impedance match for NF and input return loss. Circuit board and input matching structure losses on the input of the amplifier directly add to the overall NF of the amplifier. It is critical to minimize RF trace lengths and to use high-Q components to achieve optimal NF performance.

Components R2 and C14 provide self biasing for the device and RF grounding for one of the two source leads. Components C5 and L3 are placed on the opposing source lead and are used to tune the transistor’s source inductance.

The effect of source inductance varies with frequency. Too little source inductance increases gain and high frequency stability, but at the cost of decreased in-band stability. Too much source inductance decreases high frequency stability and gain, but increases in-band stability. It is very important to find the optimum tuning of source inductance that balances all of these variables.

The output matching topology is typical for an RF transistor. Component L3 is the RF choke that prevents RF signals from reaching the DC supply. Component C4 is the DC blocking capacitor. Components C10 and C11 improve output return loss and 3<sup>rd</sup> Order Output Intercept Point (OIP3) performance.

## Electrical and Mechanical Specifications

The absolute maximum ratings of the SKY65051-377LF are provided in Table 3. The recommended operating conditions are specified in Table 4 and electrical specifications are provided in Table 5.

Performance characteristics for the SKY65051-377LF are illustrated in Figures 3 through 11.

**Table 3. SKY65051-377LF Absolute Maximum Ratings**

Parameter	Symbol	Minimum	Typical	Maximum	Units
Input power	P <sub>IN</sub>			+10	dBm
Output power	P <sub>OUT</sub>			+20	dBm
Drain source voltage	V <sub>DS</sub>		6.0		V
Gate source voltage	V <sub>GS</sub>		-5.0		V
Gate drain voltage	V <sub>GD</sub>		-5.0		V
Drain current	I <sub>DS</sub>		55		mA
Gate current	I <sub>GS</sub>		100		μA
Power dissipation	P <sub>DIS</sub>		240		mW
Channel temperature	T <sub>CHAN</sub>		150		°C
Storage temperature	T <sub>STG</sub>	-65		+125	°C
Operating temperature	T <sub>OP</sub>	-40		+85	°C

**Note:** Exposure to maximum rating conditions for extended periods may reduce device reliability. There is no damage to device with only one parameter set at the limit and all other parameters set at or below their nominal value.

**CAUTION:** Although this device is designed to be as robust as possible, Electrostatic Discharge (ESD) can damage this device. This device must be protected at all times from ESD. Static charges may easily produce potentials of several kilovolts on the human body or equipment, which can discharge without detection. Industry-standard ESD precautions should be used at all times.

**Table 4. SKY65051-377LF Recommended Operating Conditions**

Parameter	Symbol	Minimum	Typical	Maximum	Units
Supply voltage	V <sub>DD</sub>	2	3	5	V
Supply current	I <sub>DD</sub>	5	20	50	mA

**Table 5. SKY65051-377LF Electrical Specifications (Note 1)**

**(T<sub>OP</sub> = +25 °C, Characteristic Impedance [Z<sub>0</sub>] = 50 Ω, V<sub>DD</sub> = 3 V, I<sub>DD</sub> = 20 mA, Parameters Include a 2.4 GHz Matching Network, Unless Otherwise Noted)**

Parameter	Symbol	Test Condition	Min	Typical	Max	Units
Saturated drain current	I <sub>DSS</sub>	V <sub>DS</sub> = 2 V, V <sub>GS</sub> = 0 V	40	55	70	mA
Pinchoff voltage	V <sub>P</sub>	V <sub>DS</sub> = 2 V, I <sub>DS</sub> = 2.5% of I <sub>DSS</sub>	-0.95	-0.80	-0.65	V
Transconductance	g <sub>M</sub>	V <sub>DS</sub> = 2 V, g <sub>M</sub> = ΔI <sub>DS</sub> /ΔV <sub>GS</sub> , measured at I <sub>DS</sub> = 20 % of I <sub>DSS</sub>	40	80	120	mS
Gate leakage current	I <sub>GSS</sub>	V <sub>GD</sub> = V <sub>GS</sub> = -3 V		1	200	μA
Noise Figure	NF1 (Note 2) NF2 (Note 3)	@ 2.4 GHz		0.40 0.65	0.85	dB dB
Gain	S <sub>21</sub>	@ 2.4 GHz	13.5	15.5	17.5	dB
Input return loss	S <sub>11</sub>	@ 2.4 GHz		-25		dB
Output return loss	S <sub>22</sub>	@ 2.4 GHz		-8		dB
Reverse isolation	S <sub>12</sub>	@ 2.4 GHz		-23.5		dB
3 <sup>rd</sup> Order Output Intercept Point	OIP3	P <sub>OUT</sub> = -10 dBm/tone, ΔF = 1 MHz, @ 2.4 GHz		+24.0		dBm
3 <sup>rd</sup> Order Input Intercept Point	IIP3	P <sub>OUT</sub> = -10 dBm/tone, ΔF = 1 MHz, @ 2.4 GHz		+8.5		dBm
1 dB Output Compression Point	OP1dB	@ 2.4 GHz		+12.0		dBm
1 dB Input Compression Point	IP1dB	@ 2.4 GHz		-2.5		dBm
Stability		Unconditionally stable, DC - 18 GHz		>1		K

**Note 1:** Performance is guaranteed only under the conditions listed in this Table and is not guaranteed over the full operating or storage temperature ranges. Exceeding any of the conditions listed here may result in permanent damage to the device. Operation at elevated temperatures may reduce reliability of the device.

**Note 2:** NF of device only. Input RF connector, board, and input matching network loss de-embedded from measurement.

**Note 3:** NF of device and matching network. Input RF connector and board loss de-embedded from measurement.

### Typical Performance Characteristics

**(T<sub>OP</sub> = +25 °C, Characteristic Impedance [Z<sub>0</sub>] = 50 Ω, V<sub>DD</sub> = 3 V, I<sub>DD</sub> = 20 mA, Includes a 2.4 GHz Matching Network, Unless Otherwise Noted)**

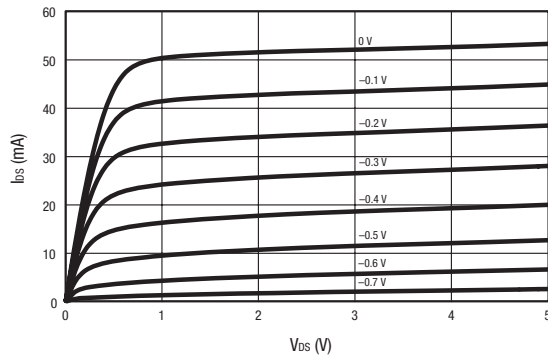

**Figure 3. Typical IV Curves**

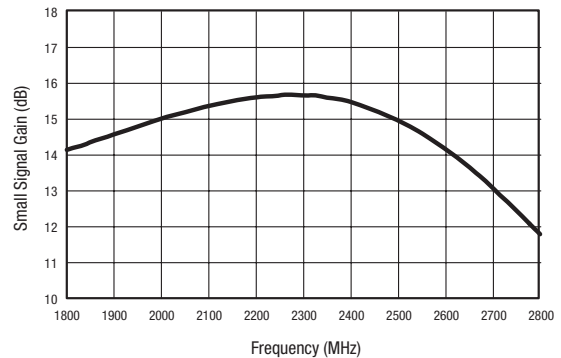

**Figure 4. Small Signal Gain vs Frequency, P<sub>IN</sub> = -20 dBm**

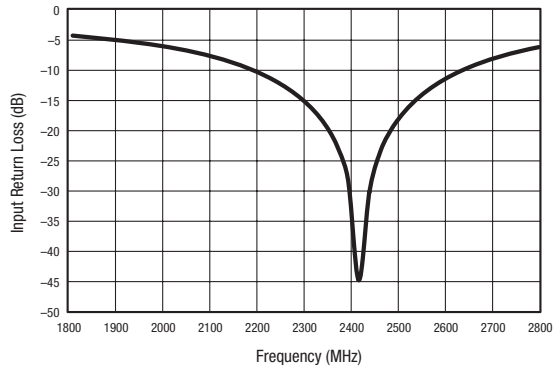

Figure 5. Input Return Loss vs Frequency,  $P_{IN} = -20$  dBm

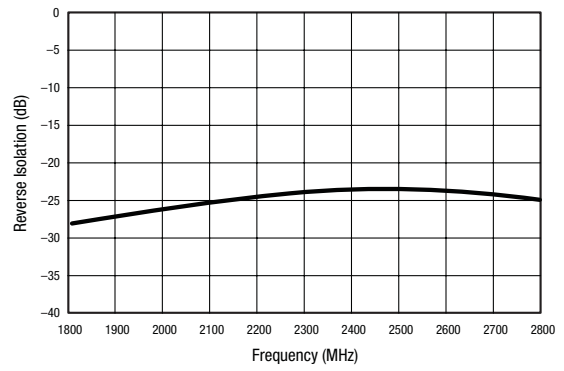

Figure 6. Reverse Isolation vs Frequency,  $P_{IN} = -20$  dBm

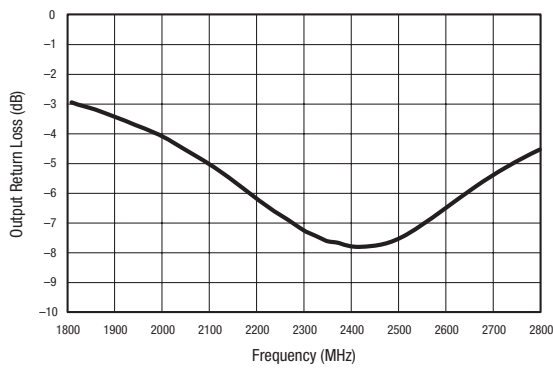

Figure 7. Output Return Loss vs Frequency,  $P_{IN} = -20$  dBm

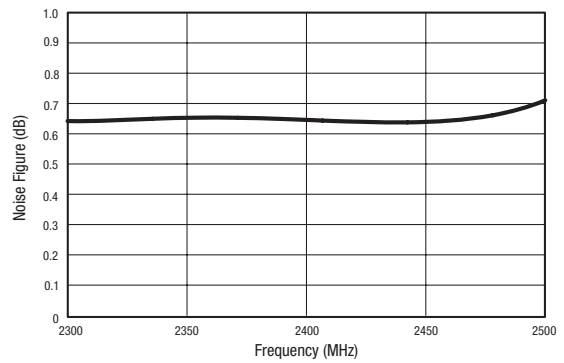

Figure 8. NF vs Frequency, Input RF Connector and Board Loss De-Embedded From Measurement

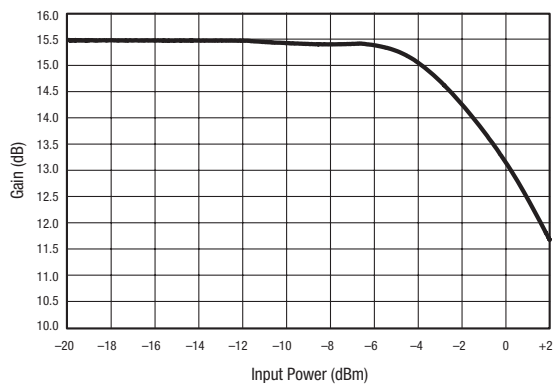

Figure 9. Gain vs Input Power,  $F = 2.4$  GHz

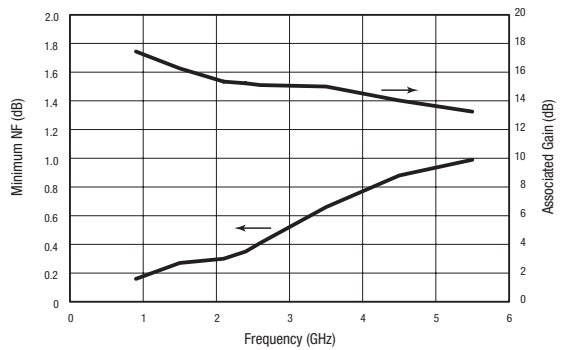
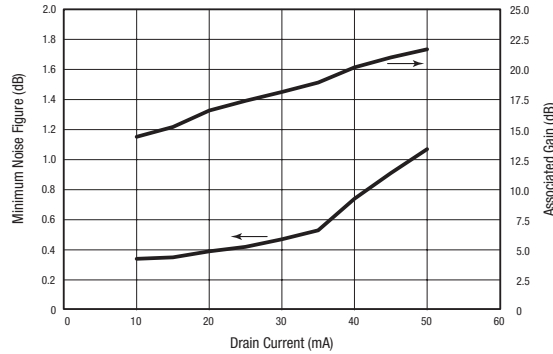

Figure 10. Minimum NF and Associated Gain vs Frequency,  $I_{DD} = 15$  mA



**Figure 11. Minimum NF and Associated Gain vs Drain Current, F = 2.4 GHz**

### Evaluation Board Description

The SKY65051-377LF Evaluation Board is used to test the performance of the SKY65051-377LF low noise transistor. An assembly drawing for the Evaluation Board is shown in Figure 12. The Evaluation Board schematic diagram is shown in Figure 13. Table 6 provides the Bill of Materials (BOM) list for Evaluation Board components.

The board is populated for 2.4 GHz operation and contains a separate probe footprint for general device testing or source and load pull characterization. The board is provisioned with two RF connectors and a 3-pin DC launch. The RF connector and board loss up to component C1 is approximately 0.15 dB at 2.4 GHz.

Board material is 10 mil thick VT47 FR4 with 1 oz. copper cladding. RF input and output traces are 50 Ω.

---

**Caution:** Do not ground the exposed pad.

---

### Evaluation Board Test Procedure

- Step 1: Connect RF test equipment to amplifier input/output SMA connectors.
- Step 2: Connect DC ground.
- Step 3: Connect VDD to a +3 V supply with a current limit of 60 mA. Verify that the board draws approximately 20 mA.
- Step 4: Apply RF signal or noise source and verify performance detailed in Table 5.

### Package Dimensions

Package dimensions for the 4-pin QFN are shown in Figure 14, and tape and reel dimensions are provided in Figure 15.

### Package and Handling Information

Since the device package is sensitive to moisture absorption, it is baked and vacuum packed before shipping. Instructions on the shipping container label regarding exposure to moisture after the container seal is broken must be followed. Otherwise, problems related to moisture absorption may occur when the part is subjected to high temperature during solder assembly.

THE SKY65051-377LF is rated to Moisture Sensitivity Level 1 (MSL1) at 260 °C. It can be used for lead or lead-free soldering.

Care must be taken when attaching this product, whether it is done manually or in a production solder reflow environment. Production quantities of this product are shipped in a standard tape and reel format. For packaging details, refer to the Skyworks Application Note, *Discrete Devices and IC Switch/Attenuators Tape and Reel Package Orientation*, document number 200083.

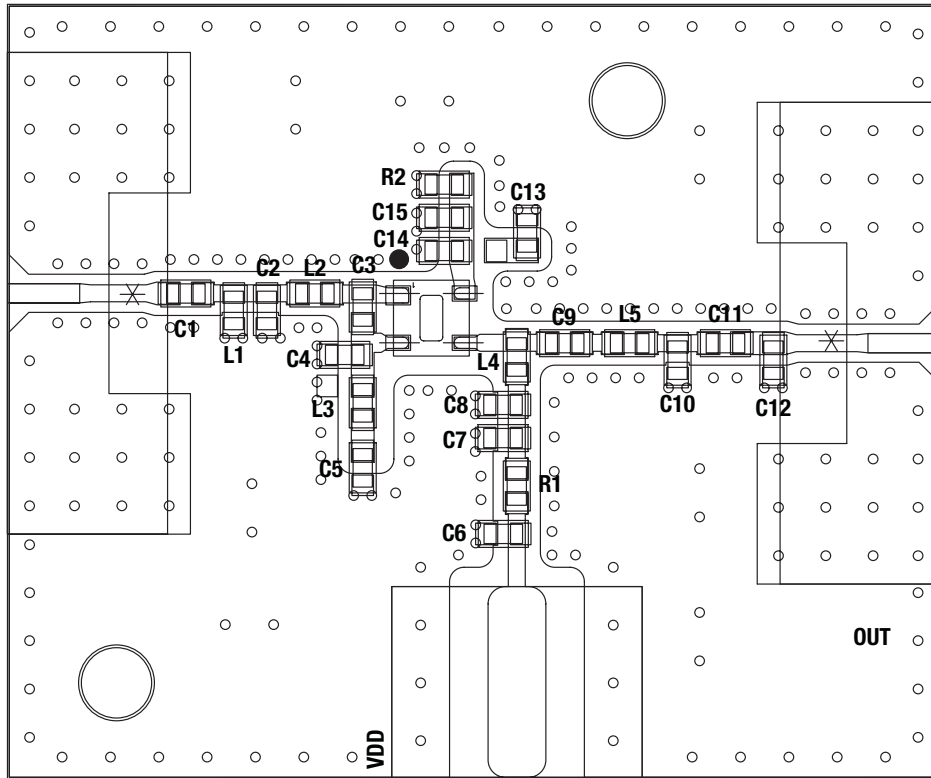

Caution: Do not ground the exposed pad.

S1412

Figure 12. SKY65051-377LF Evaluation Board Assembly Diagram

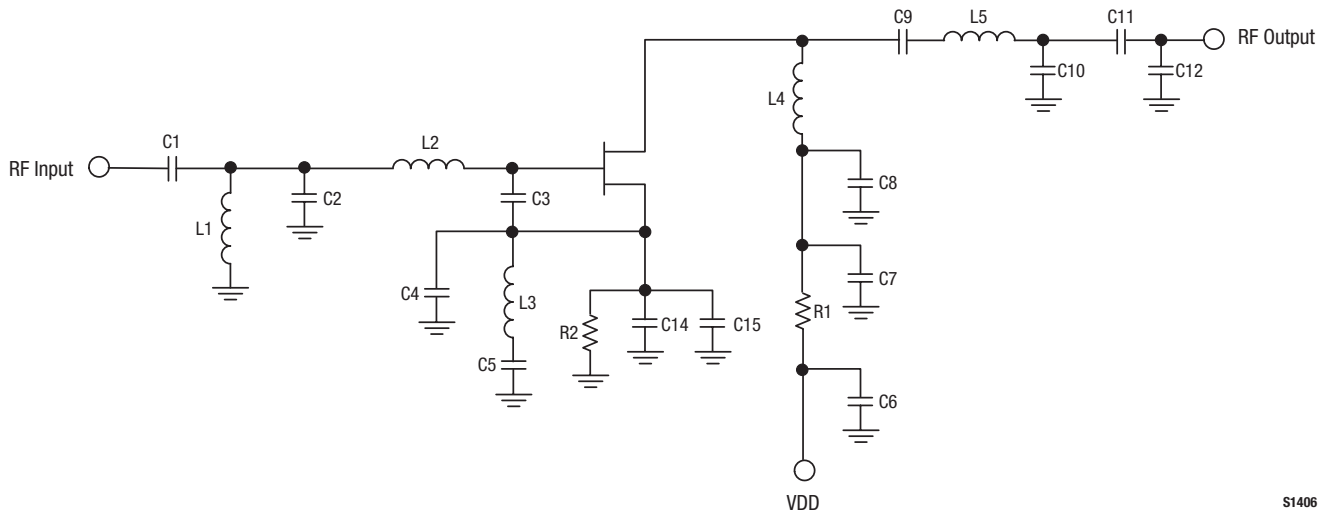

S1406

Figure 13. SKY65051-377LF Evaluation Board Schematic

**Table 6. SKY65051-377LF (QFN Package) Evaluation Board Bill of Materials**

Component	Value	Size	Manufacturer	Part Number
C1	20 pF	SMT 0402	Murata	GJM Series
C2	8.2 nH	SMT 0402	Coilcraft	CS Series
C3	0.2 pF	SMT 0402	Murata	GJM Series
C4, C6, C7, C12, C13, C15	DNP			
C5	1000 pF	SMT 0402	Murata	GRM Series
C8	22 pF	SMT 0402		
C9	1.8 pF	SMT 0402	Murata	GRM Series
C10	0.5 pF	SMT 0402	Murata	GRM Series
C11	3.3 nH	SMT 0402	TDK	MLG Series
C14	1000 pF	SMT 0402	Murata	GRM Series
C15	20 Ω	SMT 0402	Panasonic	
L1	1.5 pF	SMT 0402	Murata	GJM Series
L2	3.3 nH	SMT 0402	Coilcraft	CS Series
L3	1.6 nH	SMT 0402	TDK	MLG Series
L4	3.3 nH	SMT 0402	TDK	MLG Series
L5	0 Ω	SMT 0402	Panasonic	
R1	0 Ω	SMT 0402	Panasonic	
R2	DNP			

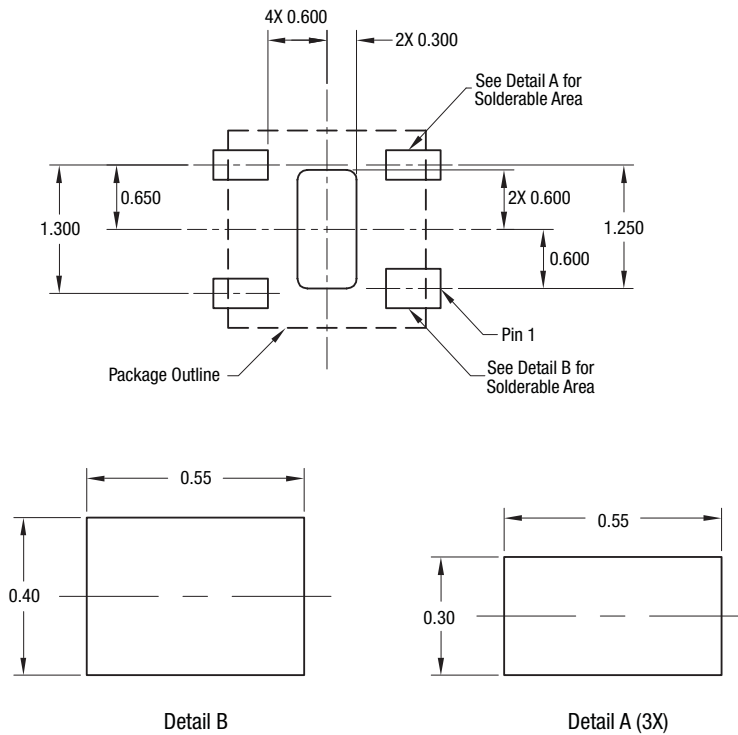

Caution: Do not ground the exposed pad.

S1416

**Figure 14. SKY65051-377LF PCB Layout Footprint**



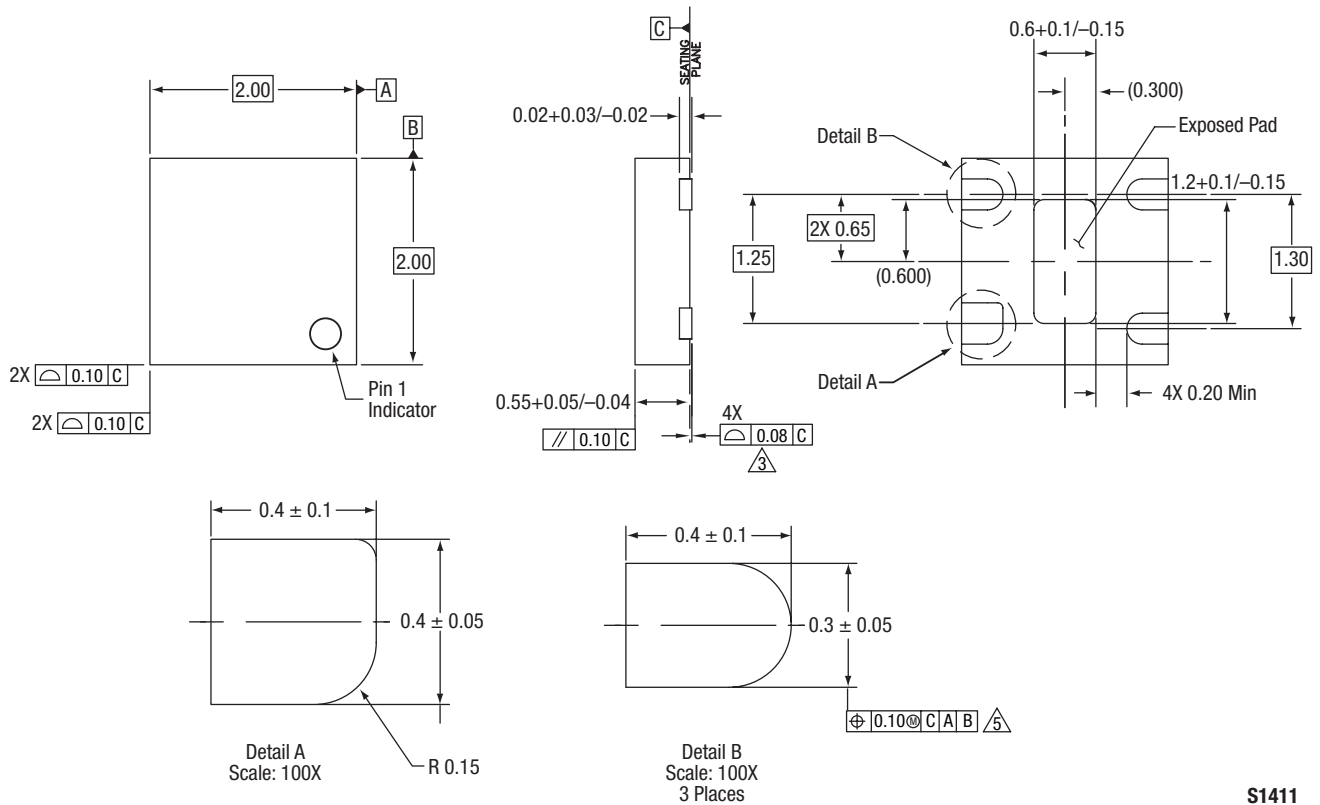

S1411

Figure 15. SKY65051-377LF 4-Pin QFN Package Dimensions

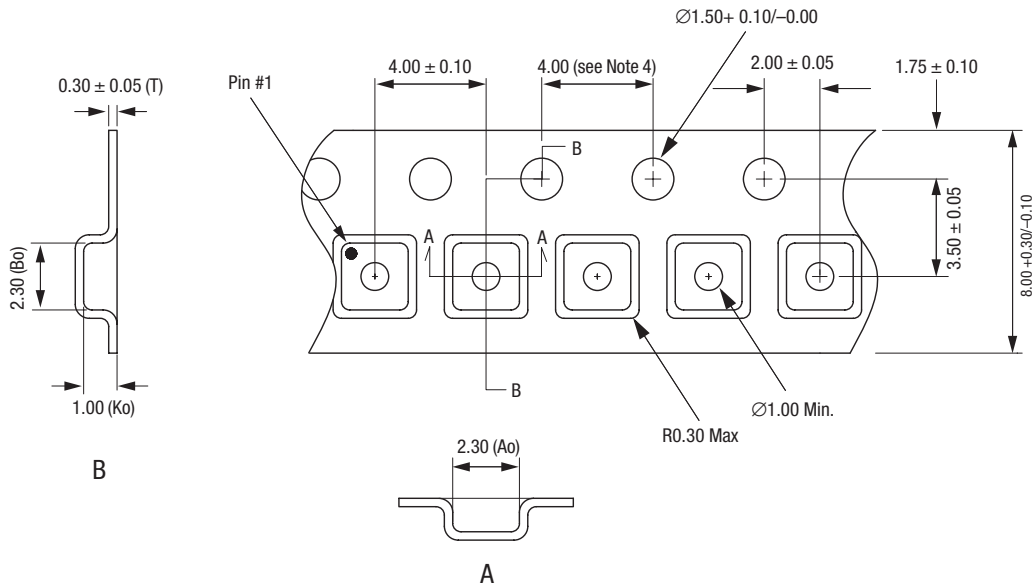

- Notes:
1. Carrier tape: black conductive polystyrene.
  2. Cover tape material: transparent conductive HSA.
  3. Cover tape size: 5.40 mm width.
  4. Ten sprocket hole pitch cumulative tolerance = ±0.20 mm.
  5. All measurements are in millimeters.

S1601

Figure 16. SKY65051-377LF Tape and Reel Dimensions

## Ordering Information

Model Name	Manufacturing Part Number	Evaluation Kit Part Number
SKY65051-377LF Low Noise Transistor	SKY65051-377LF (Pb-free package)	SKY65051-377LF (2400 MHz)

Copyright © 2009 Skyworks Solutions, Inc. All Rights Reserved.

Information in this document is provided in connection with Skyworks Solutions, Inc. ("Skyworks") products or services. These materials, including the information contained herein, are provided by Skyworks as a service to its customers and may be used for informational purposes only by the customer. Skyworks assumes no responsibility for errors or omissions in these materials or the information contained herein. Skyworks may change its documentation, products, services, specifications or product descriptions at any time, without notice. Skyworks makes no commitment to update the materials or information and shall have no responsibility whatsoever for conflicts, incompatibilities, or other difficulties arising from any future changes.

No license, whether express, implied, by estoppel or otherwise, is granted to any intellectual property rights by this document. Skyworks assumes no liability for any materials, products or information provided hereunder, including the sale, distribution, reproduction or use of Skyworks products, information or materials, except as may be provided in Skyworks Terms and Conditions of Sale.

THE MATERIALS, PRODUCTS AND INFORMATION ARE PROVIDED "AS IS" WITHOUT WARRANTY OF ANY KIND, WHETHER EXPRESS, IMPLIED, STATUTORY, OR OTHERWISE, INCLUDING FITNESS FOR A PARTICULAR PURPOSE OR USE, MERCHANTABILITY, PERFORMANCE, QUALITY OR NON-INFRINGEMENT OF ANY INTELLECTUAL PROPERTY RIGHT; ALL SUCH WARRANTIES ARE HEREBY EXPRESSLY DISCLAIMED. SKYWORKS DOES NOT WARRANT THE ACCURACY OR COMPLETENESS OF THE INFORMATION, TEXT, GRAPHICS OR OTHER ITEMS CONTAINED WITHIN THESE MATERIALS. SKYWORKS SHALL NOT BE LIABLE FOR ANY DAMAGES, INCLUDING BUT NOT LIMITED TO ANY SPECIAL, INDIRECT, INCIDENTAL, STATUTORY, OR CONSEQUENTIAL DAMAGES, INCLUDING WITHOUT LIMITATION, LOST REVENUES OR LOST PROFITS THAT MAY RESULT FROM THE USE OF THE MATERIALS OR INFORMATION, WHETHER OR NOT THE RECIPIENT OF MATERIALS HAS BEEN ADVISED OF THE POSSIBILITY OF SUCH DAMAGE.

Skyworks products are not intended for use in medical, lifesaving or life-sustaining applications, or other equipment in which the failure of the Skyworks products could lead to personal injury, death, physical or environmental damage. Skyworks customers using or selling Skyworks products for use in such applications do so at their own risk and agree to fully indemnify Skyworks for any damages resulting from such improper use or sale.

Customers are responsible for their products and applications using Skyworks products, which may deviate from published specifications as a result of design defects, errors, or operation of products outside of published parameters or design specifications. Customers should include design and operating safeguards to minimize these and other risks. Skyworks assumes no liability for applications assistance, customer product design, or damage to any equipment resulting from the use of Skyworks products outside of stated published specifications or parameters.

Skyworks, the Skyworks symbol, and "Breakthrough Simplicity" are trademarks or registered trademarks of Skyworks Solutions, Inc., in the United States and other countries. Third-party brands and names are for identification purposes only, and are the property of their respective owners. Additional information, including relevant terms and conditions, posted at [www.skyworksinc.com](http://www.skyworksinc.com), are incorporated by reference.