

MITSUBISHI DIODE MODULES

# RM250DZ/CZ/UZ-M,-H,-24,-2H

HIGH POWER GENERAL USE  
INSULATED TYPE

RM250DZ/CZ/UZ-M,-H,-24,-2H



(DZ Type)

- **IF(AV)** Average forward current ..... **250A**
- **VRRM** Repetitive peak reverse voltage  
..... **400/800/1200/1600V**

- **DOUBLE ARMS**
- **Insulated Type**
- **UL Recognized**

Yellow Card No. E80276 (N)  
File No. E80271

### APPLICATION

AC motor controllers, DC motor controllers, Battery DC power supplies,  
DC power supplies for control panels, and other general DC power equipment

### OUTLINE DRAWING & CIRCUIT DIAGRAM

Dimensions in mm

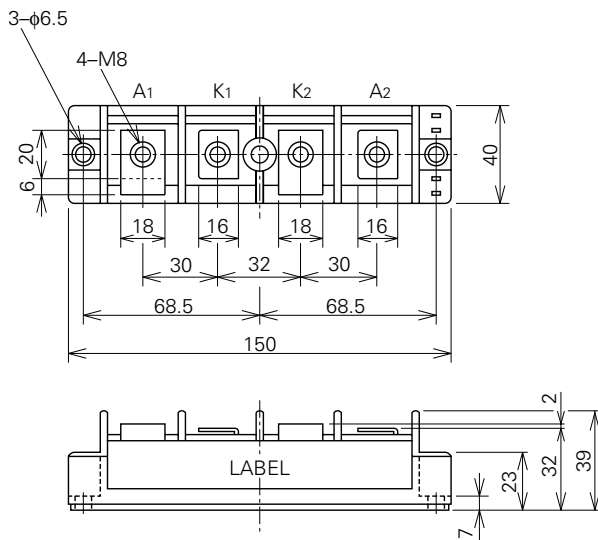

(DZ Type)

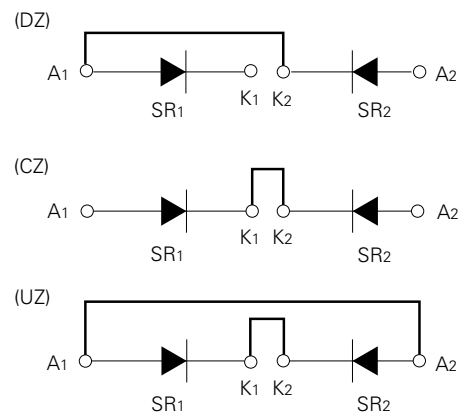

(Bold line is connective bar.)

## RM250DZ/CZ/UZ-M,-H,-24,-2H

HIGH POWER GENERAL USE  
INSULATED TYPE

## ABSOLUTE MAXIMUM RATINGS

Symbol	Parameter	Voltage class				Unit
		M	H	24	2H	
VRRM	Repetitive peak reverse voltage	400	800	1200	1600	V
VRSM	Non-repetitive peak reverse voltage	480	960	1350	1700	V
VR (DC)	Reverse DC voltage	320	640	960	1280	V

Symbol	Parameter	Conditions	Ratings	Unit
IF (RMS)	RMS forward current		390	A
IF (AV)	Average forward current	Single-phase, half-wave 180° conduction, Tc=89°C	250	A
IFSM	Surge (non-repetitive) forward current	One half cycle at 60Hz, peak value	5000	A
I <sup>2</sup> t	I <sup>2</sup> t for fusing	Value for one cycle of surge current	1.0 × 10 <sup>5</sup>	A <sup>2</sup> s
f	Maximum operating frequency		1000	Hz
Tj	Junction temperature		-40~+150	°C
Tstg	Storage temperature		-40~+125	°C
Viso	Isolation voltage	Charged part to case	2500	V
—	Mounting torque	Main terminal screw M8	8.83~10.8	N·m
			90~110	kg·cm
		Mounting screw M6	1.96~3.92	N·m
—	Weight	Typical value	20~40	kg·cm
			300	g

## ELECTRICAL CHARACTERISTICS

Symbol	Parameter	Test conditions	Limits			Unit
			Min.	Typ.	Max.	
IRRM	Repetitive reverse current	Tj=150°C, VRRM applied	—	—	30	mA
VFM	Forward voltage	Tj=25°C, IFM=750A, instantaneous meas.	—	—	1.3	V
Rth (j-c)	Thermal resistance	Junction to case (per 1/2 module)	—	—	0.2	°C/W
Rth (c-f)	Contact thermal resistance	Case to fin, conductive grease applied (per 1/2 module)	—	—	0.1	°C/W
—	Insulation resistance	Measured with a 500V megohmmeter between main terminal and case	10	—	—	MΩ

# RM250DZ/CZ/UZ-M,-H,-24.-2H

HIGH POWER GENERAL USE  
INSULATED TYPE

## PERFORMANCE CURVE

**MAXIMUM FORWARD CHARACTERISTIC**

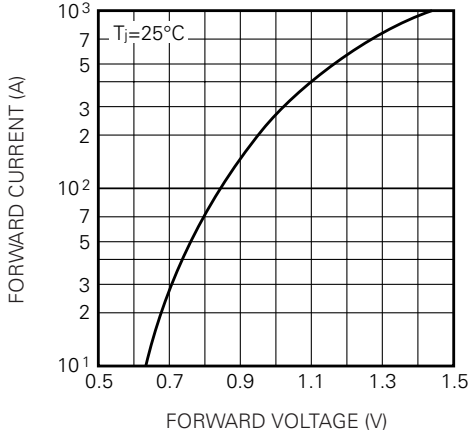

**ALLOWABLE SURGE (NON-REPETITIVE) FORWARD CURRENT**

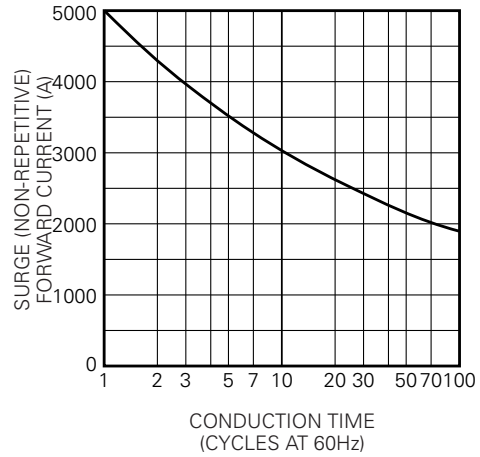

**MAXIMUM TRANSIENT THERMAL IMPEDANCE (JUNCTION TO CASE)**

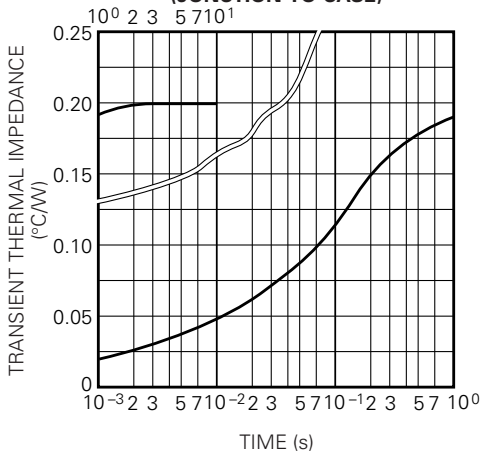

**MAXIMUM POWER DISSIPATION**

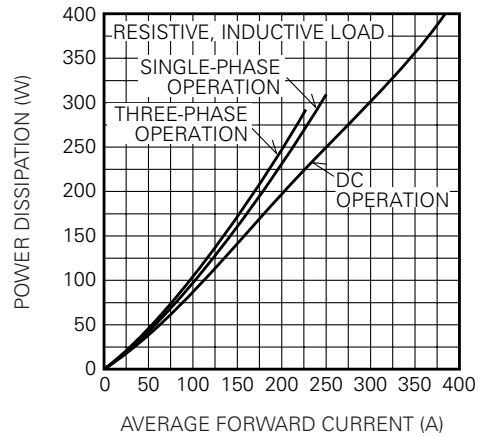

**ALLOWABLE CASE TEMPERATURE VS. AVERAGE FORWARD CURRENT**

