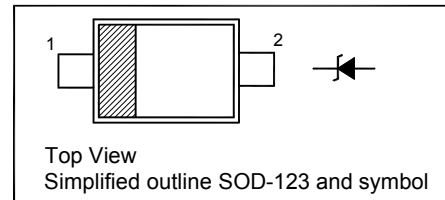

SILICON PLANAR ZENER DIODES
Features

- Total power dissipation: Max. 500 mW
- Small plastic package suitable for surface mounted design
- Tolerance approximately $\pm 5\%$

PINNING

PIN	DESCRIPTION
1	Cathode
2	Anode

Absolute Maximum Ratings ($T_a = 25\text{ }^\circ\text{C}$)

Parameter	Symbol	Value	Unit
Power Dissipation	P_{tot}	500	mW
Junction Temperature	T_j	150	$^\circ\text{C}$
Storage Temperature Range	T_{Stg}	- 55 to + 150	$^\circ\text{C}$

Characteristics at $T_a = 25\text{ }^\circ\text{C}$

Parameter	Symbol	Max.	Unit
Thermal Resistance Junction to Ambient Air	$R_{\theta JA}$	350	$^\circ\text{C/W}$
Forward Voltage at $I_F = 10\text{ mA}$	V_F	0.9	V

Characteristics at T_a = 25 °C

Type	Marking Code	Zener Voltage Range ¹⁾			Dynamic Impedance ²⁾			Reverse Current	
		V _{znom} V	I _{ZT} mA	for V _{ZT} V	Z _{ZT} Ω (Max.)	Z _{ZK} Ω (Max.)	at I _{ZK} mA	I _R μA (Max.)	at V _R V
MM1Z5221B	A4	2.4	20	2.28...2.52	30	1200	0.25	100	1
MM1Z5223B	B4	2.7	20	2.57...2.84	30	1300	0.25	75	1
MM1Z5225B	C4	3.0	20	2.85...3.15	29	1600	0.25	50	1
MM1Z5226B	D4	3.3	20	3.14...3.47	28	1600	0.25	25	1
MM1Z5227B	E4	3.6	20	3.42...3.78	24	1700	0.25	15	1
MM1Z5228B	F4	3.9	20	3.71...4.1	23	1900	0.25	10	1
MM1Z5229B	H4	4.3	20	4.09...4.52	22	2000	0.25	5	1
MM1Z5230B	J4	4.7	20	4.47...4.94	19	1900	0.25	5	2
MM1Z5231B	K4	5.1	20	4.85...5.36	17	1600	0.25	5	2
MM1Z5232B	M4	5.6	20	5.32...5.88	11	1600	0.25	5	3
MM1Z5234B	N4	6.2	20	5.89...6.51	7	1000	0.25	5	4
MM1Z5235B	P4	6.8	20	6.46...7.14	5	750	0.25	3	5
MM1Z5236B	R4	7.5	20	7.13...7.88	6	500	0.25	3	6
MM1Z5237B	X4	8.2	20	7.79...8.61	8	500	0.25	3	6.5
MM1Z5239B	Y4	9.1	20	8.65...9.56	10	600	0.25	3	7
MM1Z5240B	Z4	10	20	9.5...10.5	17	600	0.25	3	8
MM1Z5241B	A5	11	20	10.45...11.55	22	600	0.25	2	8.4
MM1Z5242B	B5	12	20	11.4...12.6	30	600	0.25	1	9.1
MM1Z5243B	C5	13	9.5	12.35...13.65	13	600	0.25	0.5	9.9
MM1Z5245B	D5	15	8.5	14.25...15.75	16	600	0.25	0.1	11
MM1Z5246B	E5	16	7.8	15.2...16.8	17	600	0.25	0.1	12
MM1Z5248B	F5	18	7	17.1...18.9	21	600	0.25	0.1	14
MM1Z5249B	K9	19	6.6	18.05...19.95	23	600	0.25	0.1	14
MM1Z5250B	H5	20	6.2	19...21	25	600	0.25	0.1	15
MM1Z5251B	J5	22	5.6	20.9...23.1	29	600	0.25	0.1	17
MM1Z5252B	K5	24	5.2	22.8...25.2	33	600	0.25	0.1	18
MM1Z5253B	M9	25	5	23.75...26.25	35	600	0.25	0.1	19
MM1Z5254B	M5	27	4.6	25.65...28.35	41	600	0.25	0.1	21
MM1Z5256B	N5	30	4.2	28.5...31.5	49	600	0.25	0.1	23
MM1Z5257B	P5	33	3.8	31.35...34.65	58	700	0.25	0.1	25
MM1Z5258B	R5	36	3.4	34.2...37.8	70	700	0.25	0.1	27
MM1Z5259B	X5	39	3.2	37.05...40.95	80	800	0.25	0.1	30
MM1Z5260B	Y5	43	3	40.85...45.15	93	900	0.25	0.1	33
MM1Z5261B	Z5	47	2.7	44.65...49.35	105	1000	0.25	0.1	36
MM1Z5262B	A6	51	2.5	48.45...53.55	125	1100	0.25	0.1	39
MM1Z5263B	B6	56	2.2	53.2...58.8	150	1300	0.25	0.1	43
MM1Z5265B	C6	62	2	58.9...65.1	185	1400	0.25	0.1	47
MM1Z5266B	D6	68	1.8	64.6...71.4	230	1600	0.25	0.1	52
MM1Z5267B	E6	75	1.7	71.25...78.75	270	1700	0.25	0.1	56

¹⁾ V_Z is tested with pulses (20 ms)

²⁾ Z_{ZT} and Z_{ZK} are measured by dividing the AC voltage drop across the device by the AC current applied. The specified limits are for I_{Z(AC)} = 0.1 I_{Z(DC)} with the AC frequency = 1 KHz.

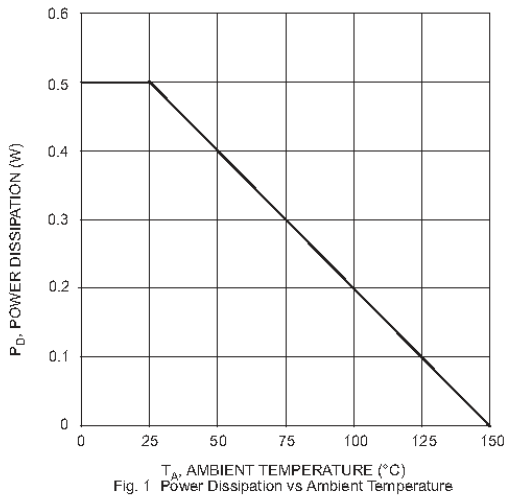

Fig. 1 Power Dissipation vs Ambient Temperature

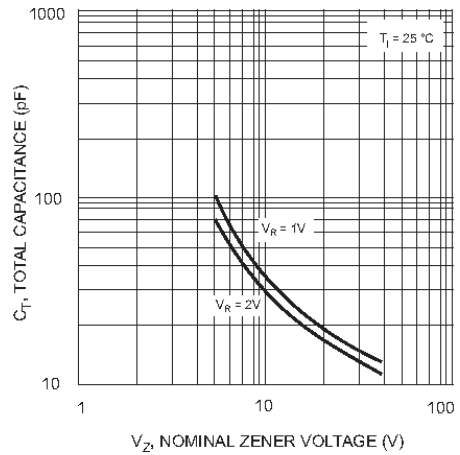

Fig. 2 Total Capacitance vs Nominal Zener Voltage

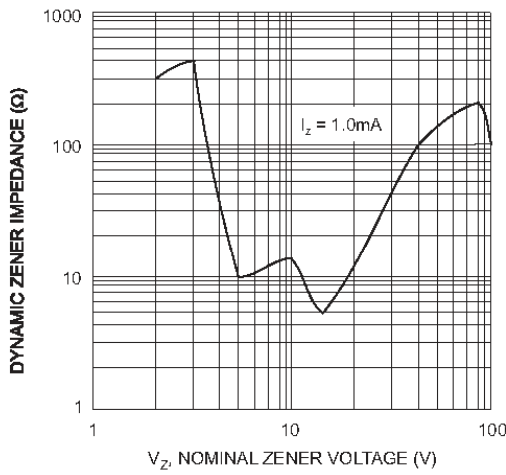

Fig. 3 Zener Voltage vs. Zener Impedance

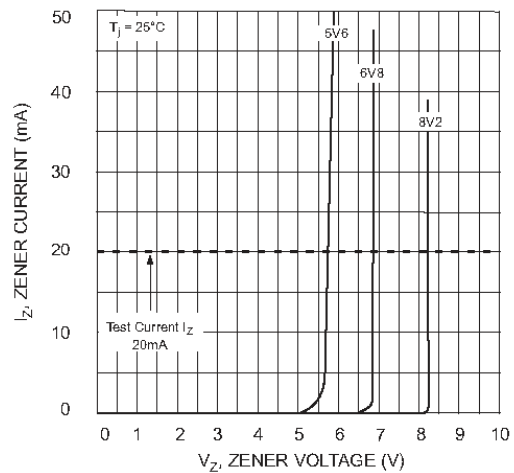

Fig. 4 Zener Breakdown Characteristics

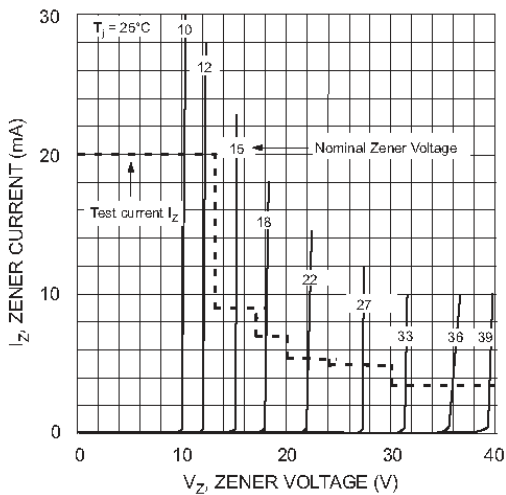
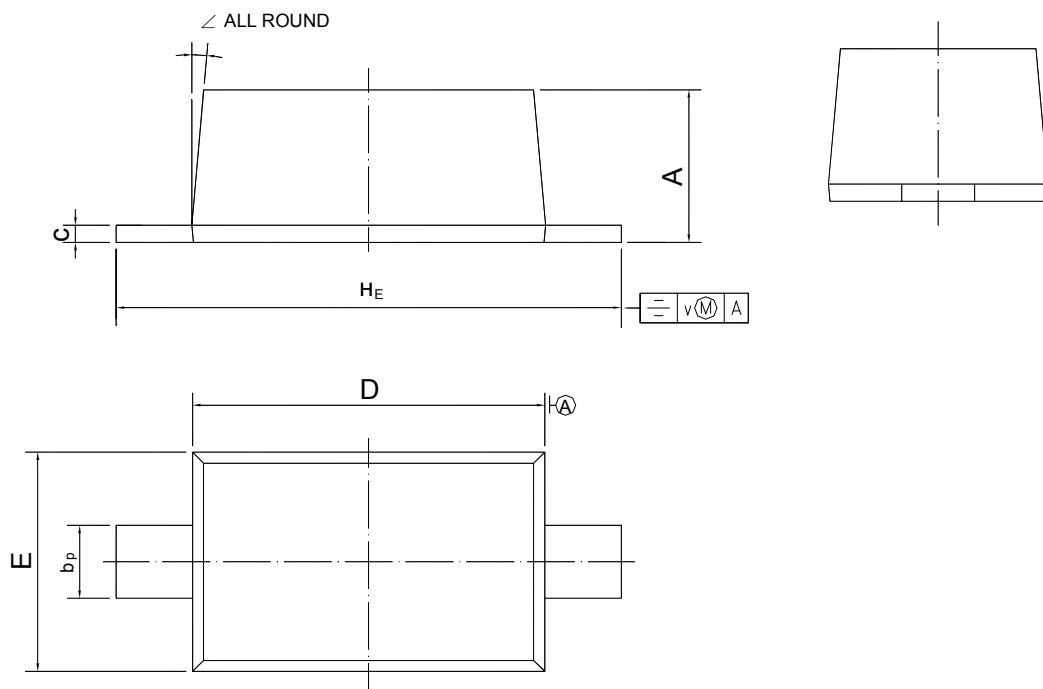

Fig. 5 Zener Breakdown Characteristics

PACKAGE OUTLINE

Plastic surface mounted package; 2 leads

SOD-123



UNIT	A	b _p	c	D	E	H _E	v	∠
mm	1.15 1.05	0.6 0.5	0.135 0.100	2.7 2.6	1.65 1.55	3.9 3.7	0.2	5°