



Low-Cost, Multiple-Output Power Supply for LCD Monitors/TVs

MAX8728

General Description

The MAX8728 generates all the supply rails for thin-film transistor (TFT) liquid-crystal display (LCD) panels in TVs and monitors. It includes step-down and step-up regulators, positive and negative charge pumps, and a dual-mode, logic-controlled high-voltage switch control block. The MAX8728 can operate from input voltages from 7V to 13.2V and is optimized for LCD TV panel and LCD monitor applications running directly from 12V supplies.

The step-up and step-down regulators feature internal power MOSFETs and high-frequency operation allowing the use of small inductors and capacitors, resulting in a compact solution. Both switching regulators use fixed-frequency, current-mode control architectures, providing fast load-transient response and easy compensation. The positive and negative charge-pump regulators provide TFT gate-driver supply voltages. Both output voltages can be adjusted with external resistive voltage-dividers.

The MAX8728 is available in a small (5mm x 5mm), low-profile (0.8mm), 32-pin TQFN package and operates over the -40°C to +85°C temperature range.

Applications

LCD Monitors LCD TVs

Ordering Information

PART	TEMP RANGE	PIN-PACKAGE	PACKAGE CODE
MAX8728ETJ+	-40°C to +85°C	32 TQFN-EP* 5mm x 5mm	T3255-4

+Denotes lead-free package.
*EP = Exposed pad.

Pin Configuration

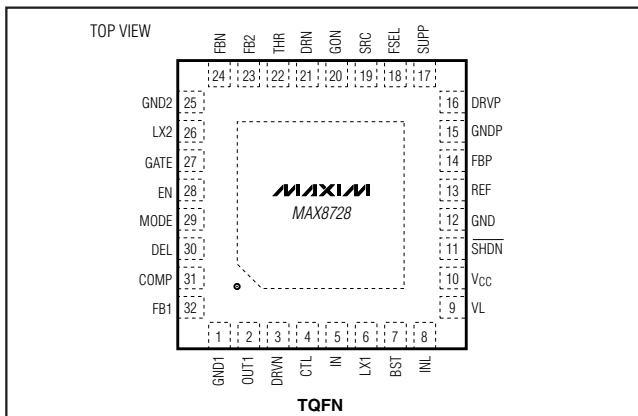

True Shutdown is a trademark of Maxim Integrated Products, Inc.

Features

- ◆ Optimized for 10.8V to 13.2V Input Supply
- ◆ 7V to 13.2V Input Supply Range
- ◆ Selectable Frequency (500kHz/1MHz/1.5MHz)
- ◆ Current-Mode Step-Down Regulator
 - 14V Internal n-Channel MOSFET
 - 1.5% Accurate Output
- ◆ Current-Mode Step-Up Regulator
 - 19V Internal n-Channel MOSFET
 - 1% Accurate Output
 - True Shutdown™ (Output Goes to Zero)
- ◆ 180° Out-of-Phase Switching
- ◆ Adjustable Positive/Negative Charge Pumps
- ◆ Soft-Start and Timer Delay Fault Latch for All Outputs
- ◆ Logic-Controlled, High-Voltage Switches
- ◆ Power-Up and Power-Down Sequences
- ◆ Thermal-Overload Protection

Simplified Operating Circuit

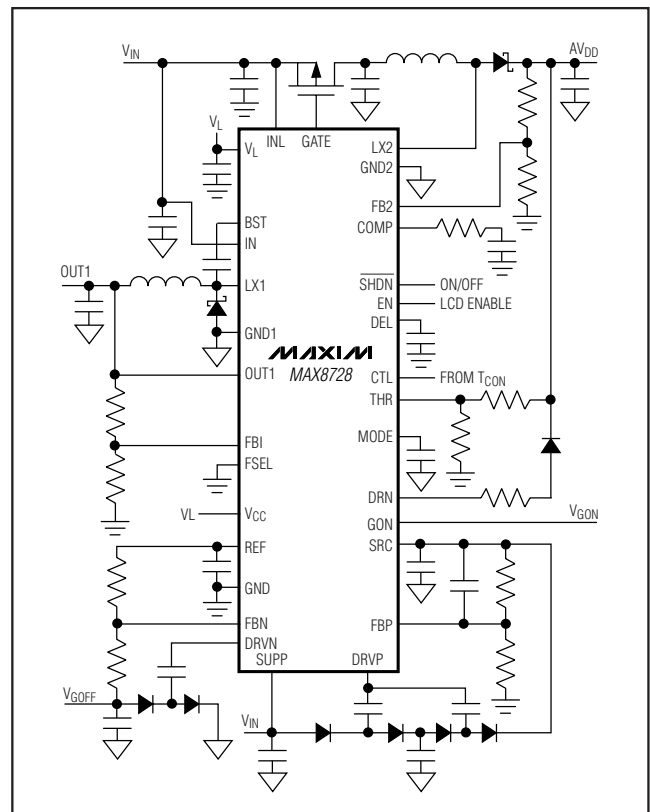

For pricing, delivery, and ordering information, please contact Maxim/Dallas Direct! at 1-888-629-4642, or visit Maxim's website at www.maxim-ic.com.

Low-Cost, Multiple-Output Power Supply for LCD Monitors/TVs

ABSOLUTE MAXIMUM RATINGS

IN, INL, SUPP to GND	-0.3V to +14V
SUPP to IN	±0.3V
DRVP to GNDP	-0.3V to V _{SUPP} + 0.3V
CTL, EN, $\overline{\text{SHDN}}$, OUT1, VL, VCC to GND	-0.3V to +6V
COMP, FB1, FB2, FBN, FBP, FSEL, DEL, THR, MODE, REF to GND	-0.3V to V _{CC} + 0.3V
GND1, GND2, GNDP to GND	±0.3V
BST to GND1	-0.3V to +20V
LX1 to BST	-6V to +0.3V
LX2 to GND2	-0.3V to +19V
DRVN, LX1, GATE to GND1	-0.3V to V _{IN} + 0.3V
GON, SRC to GND	-0.3V to +40V
SRC to GON	-0.3V to +40V
SRC to SUPP	-0.3V to +30V
SRC to SUPP (momentary)	-14V to +30V
GON to SUPP	-14V to +30V

SRC to DRN	-0.3V to +40V
DRN to GND	-0.3V to +40V
GON to DRN	-0.3V to +30V
VL Short Circuit to GND	Momentary
REF Short Circuit to GND	Continuous
DRVN RMS Current	-400mA
DRVP RMS Current	+100mA
LX2 RMS Current	+1.6A
GND2 RMS Current	+1.6A
LX1 RMS Current	-1.6A
Continuous Power Dissipation (T _A = +70°C)	
32-Pin Thin QFN (derate 34.5mW/°C above +70°C)	2758mW
Operating Temperature Range	-40°C to +85°C
Junction Temperature	+150°C
Storage Temperature Range	-65°C to +160°C
Lead Temperature (soldering, 10s)	+300°C

Stresses beyond those listed under "Absolute Maximum Ratings" may cause permanent damage to the device. These are stress ratings only, and functional operation of the device at these or any other conditions beyond those indicated in the operational sections of the specifications is not implied. Exposure to absolute maximum rating conditions for extended periods may affect device reliability.

ELECTRICAL CHARACTERISTICS

(Circuit of Figure 1, V_{IN} = V_{INL} = V_{SUPP} = 12V, V_{OUT1} = +3.3V, V_{SRC} = 28V, GND1 = GND2 = GNDP = GND = 0, I_{REF} = 0, T_A = 0°C to +85°C. Typical values are at T_A = +25°C, unless otherwise noted.)

PARAMETER	CONDITIONS	MIN	TYP	MAX	UNITS
GENERAL					
IN, INL Input Voltage Range	For VL regulator operation	7.0	12.0	13.2	V
INL Quiescent Current	V _{FB2} = V _{FBP} = 2.2V, V _{FBN} = 0, LX2 not switching, LX1 switching		7		mA
IN Standby Supply Current	V _{IN} = 7V to 13.2V, EN = $\overline{\text{SHDN}}$ = GND			0.5	mA
Switching Frequency	FSEL = GND	1275	1500	1730	kHz
	FSEL = V _{CC}	850	1000	1150	
	FSEL = REF	425	530	610	
Phase Difference Between Step-Down/Positive and Step-Up/Negative Regulators			180		Degrees
VL REGULATOR					
VL Output Voltage	7V < V _{INL} < 13.2V, V _{FB1} = V _{FB2} = V _{FBP} = 1.9V, V _{FBN} = 0.5V, I _{VL} = 25mA	4.8	5.0	5.1	V
VL Undervoltage Lockout Threshold	VL rising, 2.5% hysteresis	3.8	4.0	4.1	V
REFERENCE					
REF Output Voltage	No external load	1.98	2.00	2.02	V
REF Load Regulation	0 < I _{REF} < 50μA			10	mV
REF Sink Current	REF in regulation	0		10	μA
REF Undervoltage Lockout Threshold	Rising edge, 200mV hysteresis		1.5		V

Low-Cost, Multiple-Output Power Supply for LCD Monitors/TVs

MAX8728

ELECTRICAL CHARACTERISTICS (continued)

(Circuit of Figure 1, $V_{IN} = V_{INL} = V_{SUPP} = 12V$, $V_{OUT1} = +3.3V$, $V_{SRC} = 28V$, $GND1 = GND2 = GNDP = GND = 0$, $I_{REF} = 0$, $T_A = 0^{\circ}C$ to $+85^{\circ}C$. Typical values are at $T_A = +25^{\circ}C$, unless otherwise noted.)

PARAMETER	CONDITIONS	MIN	TYP	MAX	UNITS
STEP-DOWN REGULATOR					
OUT1 Voltage in Fixed Mode	$V_{IN} = 7.0V$ to $13.2V$, $EN = V_{CC}$, $I_{LOAD} = 0.5A$ (Note 1)	3.25	3.30	3.35	V
FB1 Regulation Voltage in Adjustable Modes	20% to 35% duty cycle, $EN = V_{CC}$, $I_{LOAD} = 0.5A$ (Note 1)	1.97	2.00	2.03	V
FB1 Adjustable Mode Threshold Voltage		0.10	0.15	0.20	V
Output Voltage Adjust Range		2.0		3.6	V
Step-Down Regulator Fault Trip Level	Fixed mode, OUT1 falling		2.640		V
	Adjustable mode, FB1 falling	1.536	1.600	1.664	
FB1 Input Leakage Current	$V_{FB1} = 2.1V$	-100		+100	nA
Low-Frequency Operation OUT1 Threshold	LX1 only		1.3		V
Low-Frequency Operation Switching Frequency	LX1 only	FSEL = GND	250		kHz
		FSEL = V_{CC}	167		
		FSEL = REF	83		
DC Load Regulation	$0 < I_{OUT1} < 2A$, $EN = V_{CC}$		0.5		%
DC Line Regulation	$7V < V_{IN} < 13.2V$, $EN = V_{CC}$		0.1		%/V
LX1-to-IN Switch On-Resistance			200	300	m Ω
LX1-to-GND1 Switch On-Resistance		10	22	40	Ω
Positive Current Limit		2.5	2.8	3.1	A
Skip Mode I_{MAX} Threshold	$EN = GND$	0.50	0.60	0.75	A
Soft-Start Ramp Time			1.7		ms
Maximum Duty Cycle		70	77	85	%
STEP-UP REGULATOR					
Output Voltage Range		V_{IN}		17	V
Maximum Duty Cycle		65	75	85	%
Minimum On-Time			65	100	ns
FB2 Regulation Voltage	$FB2 = COMP$, $C_{COMP} = 1nF$	1.98	2.00	2.02	V
FB2 Fault Trip Level	Falling edge	1.728	1.800	1.872	V
FB2 Load Regulation	$0 < I_{AVDD} < full$, transient only		-1		%
FB2 Line Regulation	$V_{IN} = 10.8V$ to $13.2V$		0.08	0.15	%/V
FB2 Input Bias Current	$V_{FB2} = 2V$	-150		+150	nA
FB2 Transconductance	$\Delta I = \pm 2.5\mu A$ at COMP, $FB2 = COMP$	75	160	280	μS
FB2 Voltage Gain	FB2 to COMP		700		V/V
LX2 Leakage Current	$V_{FB2} = 2.1V$, $V_{LX2} = 13V$		4	40	μA
LX2 Current Limit	$V_{FB2} = 1.8V$, duty cycle is 25%	1.2	1.5	1.8	A

Low-Cost, Multiple-Output Power Supply for LCD Monitors/TVs

ELECTRICAL CHARACTERISTICS (continued)

(Circuit of Figure 1, $V_{IN} = V_{INL} = V_{SUPP} = 12V$, $V_{OUT1} = +3.3V$, $V_{SRC} = 28V$, $GND1 = GND2 = GNDP = GND = 0$, $I_{REF} = 0$, $T_A = 0^\circ C$ to $+85^\circ C$. Typical values are at $T_A = +25^\circ C$, unless otherwise noted.)

PARAMETER	CONDITIONS	MIN	TYP	MAX	UNITS
Current-Sense Transresistance		0.6	1.2	1.8	V/A
LX2 On-Resistance			0.5	1.0	Ω
Soft-Start Period			3		ms
POSITIVE CHARGE-PUMP REGULATOR					
FBP Regulation Voltage		1.98	2.00	2.02	V
FBP Line Regulation Error	$V_{IN} = V_{SUPP} = 10.8V$ to $13.2V$			6	mV
FBP Input Bias Current	$V_{FBP} = 2.1V$	-50		+50	nA
DRVP p-Channel MOSFET On-Resistance			4		Ω
DRVP n-Channel MOSFET On-Resistance			1		Ω
FBP Fault Trip Level	Falling edge	1.536	1.600	1.664	V
Positive Charge-Pump Soft-Start Period			3		ms
NEGATIVE CHARGE-PUMP REGULATOR					
FBN Regulation Voltage	$V_{REF} - V_{FBN}$	1.727	1.750	1.773	V
FBN Input Bias Current	$V_{FBN} = 250mV$	-50		+50	nA
FBN Line Regulation	$V_{IN} = 10.8V$ to $13.2V$			6	mV
DRVN p-Channel MOSFET On-Resistance			4		Ω
DRVN n-Channel MOSFET On-Resistance			1		Ω
FBN Fault Trip Level	Rising edge		600		mV
Negative Charge-Pump Soft-Start Period			3		ms
SEQUENCE CONTROL					
\overline{SHDN} Input Low Voltage				0.4	V
\overline{SHDN} Input High Voltage		2			V
\overline{SHDN} Input Current				1	μA
EN Charge Current	During startup, $V_{EN} = 1.0V$	4	5	6	μA
EN Turn-On Threshold		0.95	1.00	1.05	V
DEL Capacitor Charge Current	During startup, $V_{DEL} = 1.0V$	4	5	6	μA
DEL Turn-On Threshold		0.95	1.00	1.05	V
GATE Output Sink Current	EN = high, GATE = IN	8	11	14	μA
GATE On Voltage	EN = high	$V_{IN} - 6$	$V_{IN} - 5$	$V_{IN} - 4$	V
GATE Done Threshold	EN = high, $V_{GATE_DONE} - V_{GATE_ON}$	0	1		V
GATE Pullup Resistance	EN = low, $V_{GATE} = V_{IN} - 5V$		1		k Ω

Low-Cost, Multiple-Output Power Supply for LCD Monitors/TVs

MAX8728

ELECTRICAL CHARACTERISTICS (continued)

(Circuit of Figure 1, $V_{IN} = V_{INL} = V_{SUPP} = 12V$, $V_{OUT1} = +3.3V$, $V_{SRC} = 28V$, $GND1 = GND2 = GNDP = GND = 0$, $I_{REF} = 0$, $T_A = 0^{\circ}C$ to $+85^{\circ}C$. Typical values are at $T_A = +25^{\circ}C$, unless otherwise noted.)

PARAMETER	CONDITIONS	MIN	TYP	MAX	UNITS
DEL, EN Discharge Switch On-Resistance	\overline{SHDN} = low or fault tripped		20		Ω
FBN Discharge Switch On-Resistance	EN = low or fault tripped		5		k Ω
POSITIVE GATE-DRIVER TIMING AND CONTROL SWITCHES					
CTL Input Low Voltage				0.6	V
CTL Input High Voltage		2.0			V
CTL Input Leakage Current		-1		+1	μA
CTL-to-GON Rising Propagation Delay	1k Ω from DRN to GND, 1.5nF from GON to GND		100		ns
CTL-to-GON Falling Propagation Delay	1k Ω from DRN to GND, 1.5nF from GON to GND		250		ns
SRC Input Voltage Range				38	V
SRC Input Current	$V_{MODE} = V_{REF}$, $V_{DEL} = V_{CTL} = 3V$		1.5	2.0	mA
	$V_{MODE} = V_{REF}$, $V_{DEL} = 3V$, $V_{CTL} = 0$		0.14	0.20	
DRN Input Current	$V_{MODE} = V_{REF}$, $V_{DRN} = 8V$, $V_{DEL} = 3V$, $V_{GON} > V_{DRN}$, $V_{CTL} = 0$		0	1	μA
SRC Switch On-Resistance	$V_{MODE} = V_{REF}$, $V_{DEL} = V_{CTL} = 3V$		15	30	Ω
SRC Switch Saturation Current	$V_{MODE} = V_{REF}$, $V_{DEL} = V_{CTL} = 3V$, $V_{SRC} - V_{GON} > 5V$		260		mA
DRN Switch On-Resistance	$V_{MODE} = V_{REF}$, $V_{DEL} = 3V$, $V_{CTL} = 0$, $V_{GON} = 28V$, $V_{THR} = 1.4V$		25	50	Ω
DRN Switch Saturation Current	$V_{MODE} = V_{REF}$, $V_{DEL} = 3V$, $V_{CTL} = 0$, $V_{GON} = 28V$, $V_{THR} = 1.4V$, $V_{GON} - V_{DRN} > 5V$		100		mA
MODE Switch On-Resistance	$\overline{SHDN} = GND$		1		k Ω
MODE Current-Source Stop Voltage Threshold	MODE rising	1.2	1.4	1.6	V
MODE Charge Current	Operating mode 2, $V_{MODE} = 0.7V$	40	50	60	μA
MODE Voltage Threshold	Enabling DRN switch control in mode 2	0.8	1.0	1.2	V
THR to GON Voltage Gain		9.4	10.0	10.6	V/V
FAULT DETECTION					
Duration to Trigger Fault			50		ms
Thermal Shutdown Threshold	15 $^{\circ}C$ typical hysteresis		+160		$^{\circ}C$
SWITCHING-FREQUENCY SELECTION					
FSEL Input Levels	FSEL = V_{CC} (1MHz)	$V_{CC} - 0.4$			V
	FSEL = REF (0.5MHz)	1.65			
	FSEL = GND (1.5MHz)	0.5			
FSEL Input Current	Forced to V_{CC}		10		μA

Low-Cost, Multiple-Output Power Supply for LCD Monitors/TVs

ELECTRICAL CHARACTERISTICS

(Circuit of Figure 1, $V_{IN} = V_{INL} = V_{SUPP} = 12V$, $V_{OUT1} = +3.3V$, $V_{SRC} = 28V$, $GND1 = GND2 = GNDP = GND = 0$, $I_{REF} = 0$, $T_A = -40^{\circ}C$ to $+85^{\circ}C$.) (Note 2)

PARAMETER	CONDITIONS	MIN	TYP	MAX	UNITS
GENERAL					
IN, INL Input Voltage Range	For VL regulator operation	7.0		13.2	V
IN Standby Supply Current	$V_{IN} = 7V$ to $13.2V$, $EN = \overline{SHDN} = GND$			0.5	mA
Switching Frequency	FSEL = GND	1175		1800	kHz
	FSEL = V_{CC}	780		1150	
	FSEL = REF	400		610	
VL REGULATOR					
VL Output Voltage	$7V < V_{INL} < 13.2V$, $V_{FB1} = V_{FB2} = V_{FBP} = 1.9V$, $V_{FBN} = 0.5V$, $I_{VL} = 25mA$	4.8		5.1	V
VL Undervoltage Lockout Threshold	VL rising, 2.5% hysteresis	3.8		4.1	V
REFERENCE					
REF Output Voltage	No external load	1.97		2.02	V
REF Load Regulation	$0 < I_{RF1} < 50\mu A$			10	mV
STEP-DOWN REGULATOR					
OUT1 Voltage in Fixed Mode	$V_{IN} = 6.0V$ to $13.2V$, $EN = V_{CC}$, $I_{LOAD} = 0.5A$ (Note 1)	3.23		3.35	V
FB1 Regulation Voltage in Adjustable Mode	20% to 35% duty cycle, $EN = V_{CC}$, $I_{OUT1} = 0.5A$ (Note 1)	1.97		2.03	V
FB1 Adjustable-Mode Threshold Voltage		0.10		0.20	V
Output Voltage Adjust Range		2.0		3.6	V
Step-Down Regulator Fault Trip Level	Adjustable mode, FB1 falling	1.536		1.664	V
LX1-to-IN Switch On-Resistance				550	m Ω
LX1-to-GND1 Switch On-Resistance		8		40	Ω
Positive Current Limit		2.3		3.1	A
Skip Mode I_{MAX} Threshold	$EN = GND$	0.45		0.75	A
Maximum Duty Cycle		70		85	%
STEP-UP REGULATOR					
Output Voltage Range		V_{IN}		17	V
Maximum Duty Cycle		65		85	%
FB2 Regulation Voltage	$FB2 = COMP$, $C_{COMP} = 1nF$	1.97		2.02	V
LX2 Current Limit	$V_{FB2} = 1.8V$, duty cycle is 25%	1.2		1.8	A
LX2 On-Resistance				1	Ω

Low-Cost, Multiple-Output Power Supply for LCD Monitors/TVs

MAX8728

ELECTRICAL CHARACTERISTICS (continued)

(Circuit of Figure 1, $V_{IN} = V_{INL} = V_{SUPP} = 12V$, $V_{OUT1} = +3.3V$, $V_{SRC} = 28V$, $GND1 = GND2 = GNDP = GND = 0$, $I_{REF} = 0$, $T_A = -40^{\circ}C$ to $+85^{\circ}C$.) (Note 2)

PARAMETER	CONDITIONS	MIN	TYP	MAX	UNITS
CHARGE-PUMP REGULATORS					
FBP Regulation Voltage		1.97		2.02	V
FBN Regulation Voltage	$V_{REF} - V_{FBN}$	1.71		1.78	V
SEQUENCE CONTROL					
\overline{SHDN} Input Low Voltage				0.4	V
\overline{SHDN} Input High Voltage		2			V
EN Turn-On Threshold		0.95		1.10	V
DEL Turn-On Threshold		0.95		1.10	V
GATE On Voltage	EN = high	$V_{IN} - 6$		$V_{IN} - 4$	V
GATE Done Threshold	EN = high, $V_{GATE_DONE} - V_{GATE_ON}$	0			V
POSITIVE GATE-DRIVER TIMING AND CONTROL SWITCHES					
CTL Input Low Voltage				0.6	V
CTL Input High Voltage		2.1			V
SRC Input Voltage Range				38	V
SRC Input Current	$V_{MODE} = V_{REF}$, $V_{DEL} = V_{CTL} = 3V$			2.3	mA
	$V_{MODE} = V_{REF}$, $V_{DEL} = 3V$, $V_{CTL} = 0$			0.2	
SRC Switch On-Resistance	$V_{MODE} = V_{REF}$, $V_{DEL} = V_{CTL} = 3V$			30	Ω
DRN Switch On-Resistance	$V_{MODE} = V_{REF}$, $V_{DEL} = 3V$, $V_{CTL} = 0$, $V_{GON} = 28V$, $V_{THR} = 1.4V$			50	Ω
MODE Current-Source Stop-Voltage Threshold	MODE rising	1.2		1.6	V
MODE Voltage Threshold	Enabling DRN switch control in mode 2	0.8		1.2	V
THR-to-GON Voltage Gain		9.4		10.6	V/V

Note 1: When the inductor is in continuous conduction (EN = V_{CC} or heavy load), the output voltage has a DC regulation level lower than the error comparator threshold by 50% of the output voltage ripple. In discontinuous conduction (EN = GND with light load), the output voltage has a DC regulation level higher than the error comparator threshold by up to 50% of the output voltage ripple.

Note 2: Specifications to $-40^{\circ}C$ are guaranteed by design, not production tested.

Low-Cost, Multiple-Output Power Supply for LCD Monitors/TVs

Typical Operating Characteristics

(Circuit of Figure 1. $V_{IN} = V_{INL} = V_{SUPP} = 12V$, $AV_{DD} = 13.5V$, $V_{GON} = 28V$, $V_{GOFF} = -6V$, $V_{OUT1} = 3.3V$, $F_{SEL} = GND$, $T_A = +25^\circ C$, unless otherwise noted.)

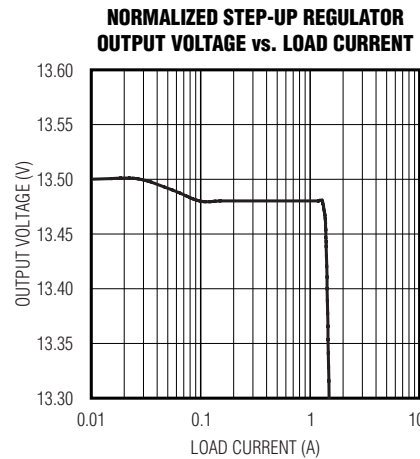
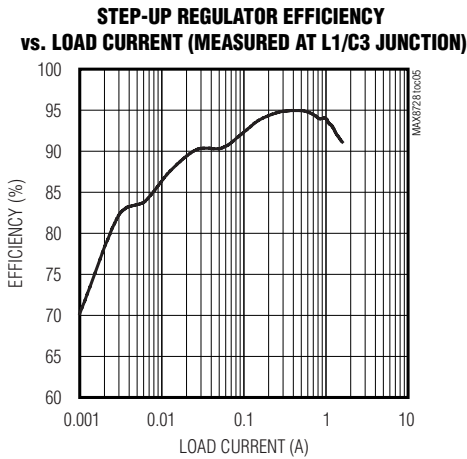
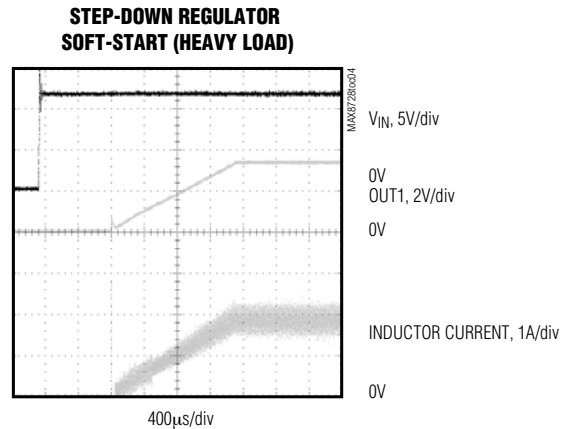
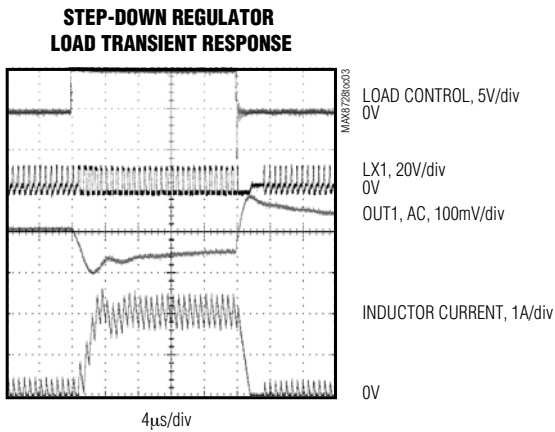
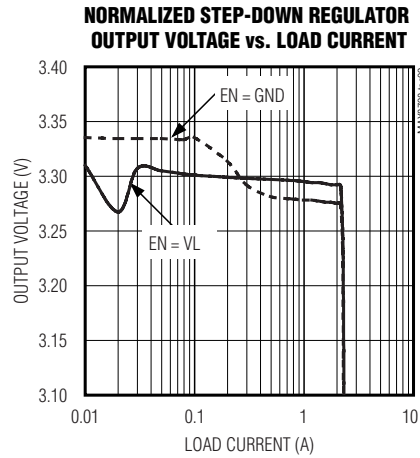
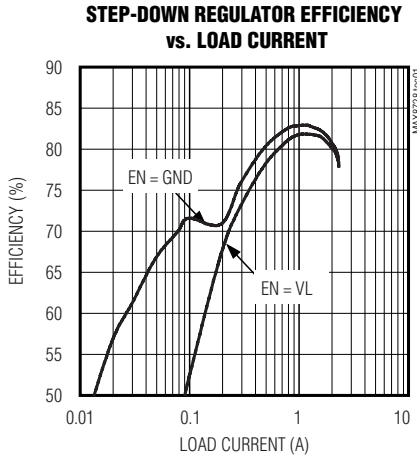

Low-Cost, Multiple-Output Power Supply for LCD Monitors/TVs

MAX8728

Typical Operating Characteristics (continued)

(Circuit of Figure 1. $V_{IN} = V_{INL} = V_{SUPP} = 12V$, $AV_{DD} = 13.5V$, $V_{GON} = 28V$, $V_{GOFF} = -6V$, $V_{OUT1} = 3.3V$, $F_{SEL} = GND$, $T_A = +25^\circ C$, unless otherwise noted.)

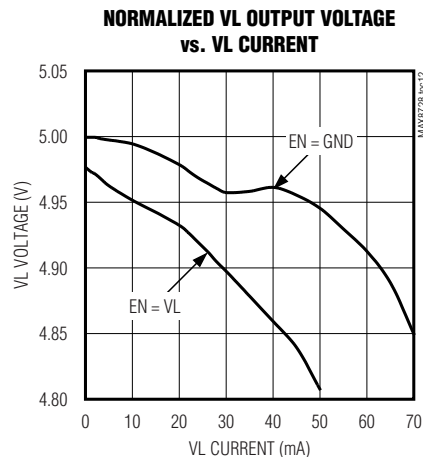
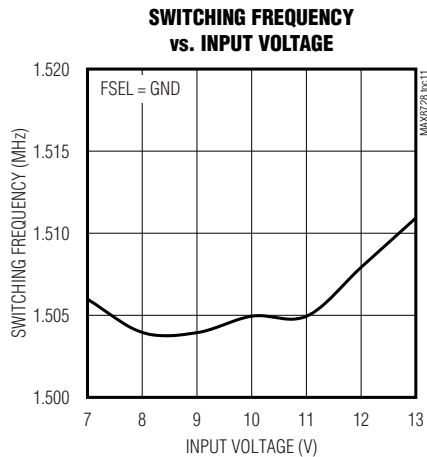
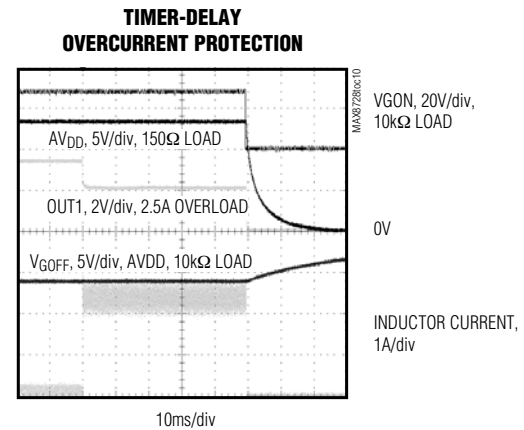
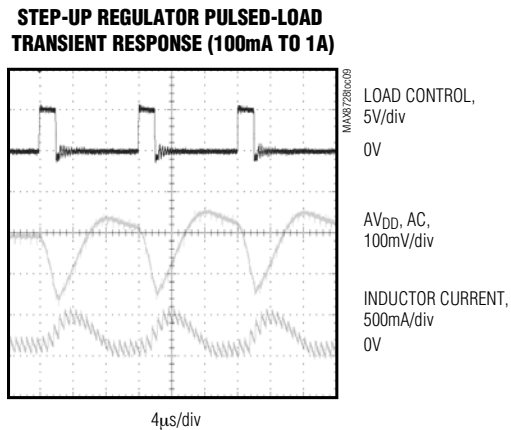
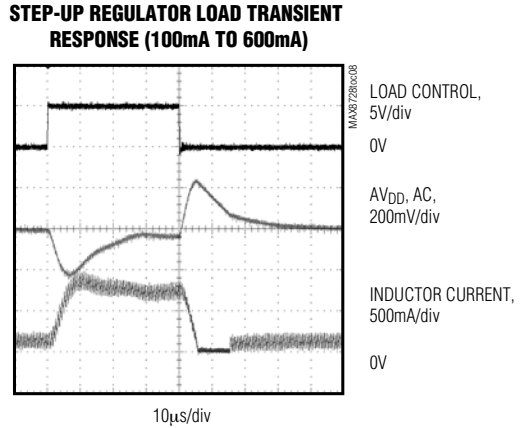
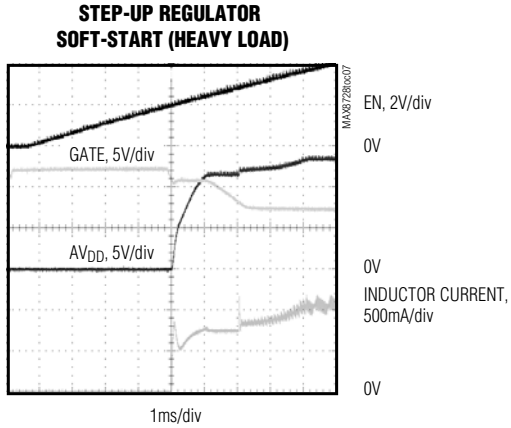

Low-Cost, Multiple-Output Power Supply for LCD Monitors/TVs

Typical Operating Characteristics (continued)

(Circuit of Figure 1. $V_{IN} = V_{INL} = V_{SUPP} = 12V$, $AV_{DD} = 13.5V$, $V_{GON} = 28V$, $V_{GOFF} = -6V$, $V_{OUT1} = 3.3V$, $FSEL = GND$, $T_A = +25^\circ C$, unless otherwise noted.)

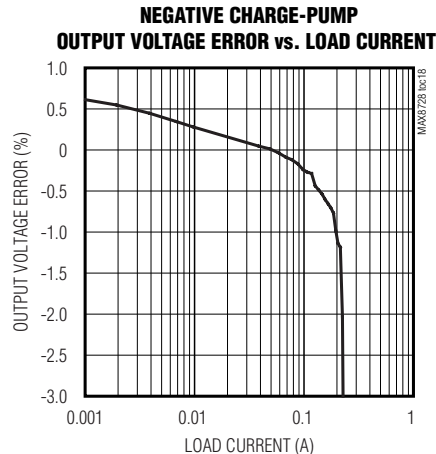
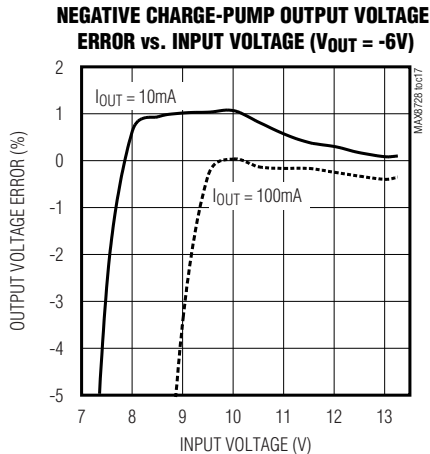
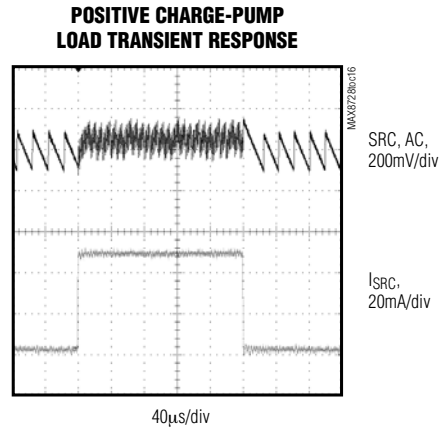
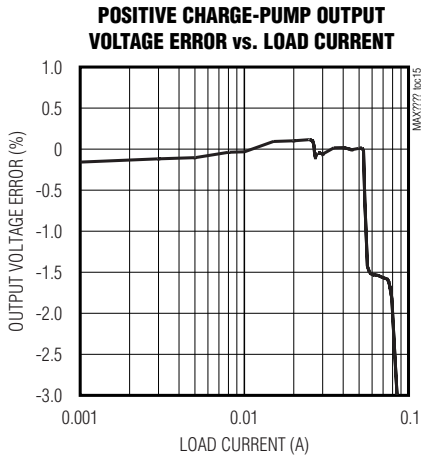
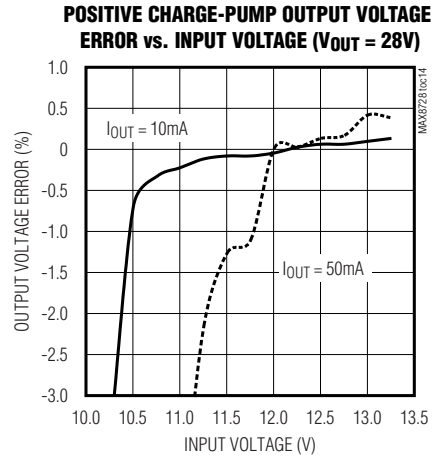
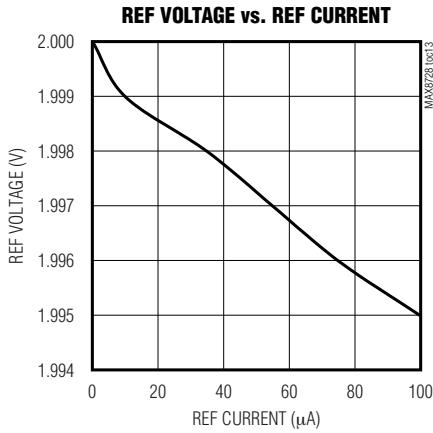

Low-Cost, Multiple-Output Power Supply for LCD Monitors/TVs

MAX8728

Typical Operating Characteristics (continued)

(Circuit of Figure 1. $V_{IN} = V_{INL} = V_{SUPP} = 12V$, $AV_{DD} = 13.5V$, $V_{GON} = 28V$, $V_{GOFF} = -6V$, $V_{OUT1} = 3.3V$, $FSEL = GND$, $T_A = +25^\circ C$, unless otherwise noted.)

NEGATIVE CHARGE-PUMP LOAD TRANSIENT RESPONSE

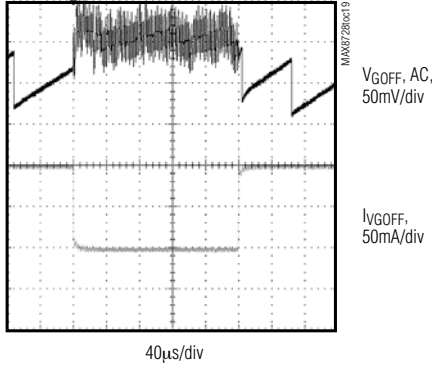

POWER-UP SEQUENCE

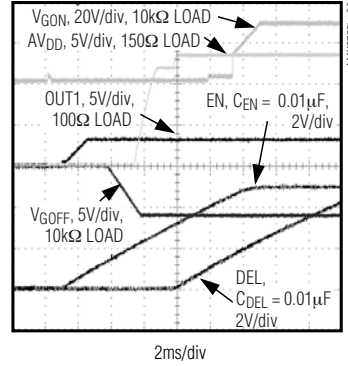

INL SUPPLY CURRENT vs. INL VOLTAGE

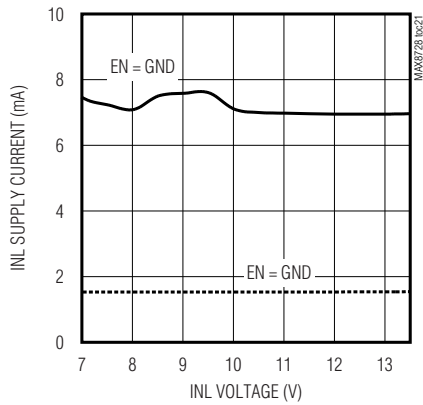

INL SUPPLY CURRENT vs. TEMPERATURE

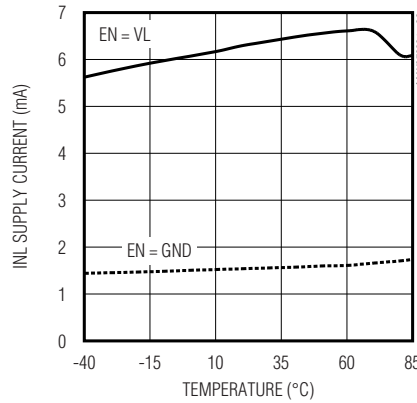

HIGH-VOLTAGE SWITCH CONTROL (MODE 1)

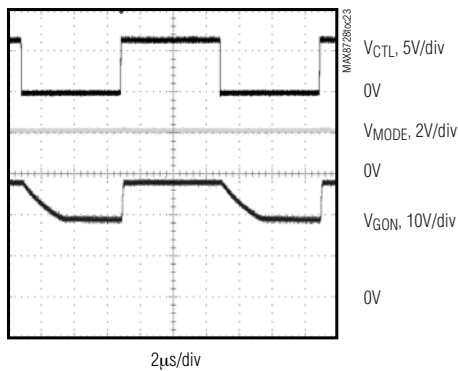

HIGH-VOLTAGE SWITCH CONTROL (MODE 2)

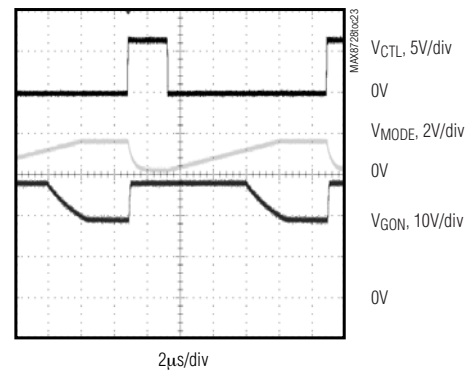

Low-Cost, Multiple-Output Power Supply for LCD Monitors/TVs

Pin Description

PIN	NAME	FUNCTION
1	GND1	Step-Down Regulator and Negative Charge-Pump Power Ground
2	OUT1	Step-Down Regulator Output Sense Input. OUT1 is the inverting input to the internal current-sense amplifier. Connect OUT1 directly to the step-down regulator output.
3	DRVN	Negative Charge-Pump Regulator Driver Output. See the <i>Negative Charge-Pump Regulator</i> section for details.
4	CTL	High-Voltage Switch-Control Block Timing Control Input. See the <i>High-Voltage Switch Control</i> section for
5	IN	Step-Down Regulator and Negative Charge-Pump Regulator Supply Input
6	LX1	Step-Down Regulator Switching Node. LX1 is the source of the internal high-side MOSFET. Connect the inductor and Schottky catch diode to LX1 and minimize the trace area for low EMI.
7	BST	Step-Down Regulator Bootstrap Pin. BST is the supply for the high-side MOSFET gate driver. Connect a 0.1 μ F ceramic capacitor from BST to LX1.
8	INL	5V Internal Linear Regulator and Startup Circuitry Supply Input. The input voltage range of INL is between +7.0V and +13.2V. Connect a 0.22 μ F ceramic capacitor between INL and GND. Place the capacitor close to the IC.
9	VL	5V Internal Linear Regulator Output. VL powers the internal MOSFET gate drivers and the control circuitry. Bypass VL to GND with a 1 μ F ceramic capacitor. VL can provide up to 25mA external load current.
10	VCC	Internal Reference Supply Input. Connect VCC directly to VL.
11	$\overline{\text{SHDN}}$	Active-Low Shutdown Control Input. All outputs (except for REF and VL) are disabled and the GATE pin goes high when $\overline{\text{SHDN}}$ is low.
12	GND	Analog Ground
13	REF	Reference Output. Connect a 0.22 μ F ceramic capacitor between REF and GND. All regulator outputs are disabled until REF exceeds its UVLO threshold.
14	FBP	Positive Charge-Pump Regulator Feedback Input. Connect FBP to the center of a resistive voltage-divider between the positive output and GND to set the positive charge-pump regulator output voltage. Place the resistive voltage-divider close to FBP.
15	GNDP	Positive Charge-Pump Power Ground
16	DRVP	Positive Charge-Pump Regulator Driver Output. See the <i>Positive Charge-Pump Regulator</i> section for details.
17	SUPP	Positive Charge-Pump Regulator Supply Input. Connect SUPP directly to IN and bypass SUPP to GNDP with a minimum 0.1 μ F ceramic capacitor.
18	FSEL	Frequency Select Pin. Connect FSEL to REF for 500kHz operation. Connect FSEL to VCC for 1MHz operation. Connect to GND for 1.5MHz operation.
19	SRC	High-Voltage Switch Control Block Input. SRC is the source of the internal, high-voltage, p-channel MOSFET.
20	GON	High-Voltage Switch Control Block Output. GON is the common junction of the internal high-voltage MOSFETs. GON is internally pulled to GND through a 4mA internal current source when the switch control block is disabled.

Low-Cost, Multiple-Output Power Supply for LCD Monitors/TVs

Pin Description (continued)

MAX8728

PIN	NAME	FUNCTION
21	DRN	High-Voltage Switch Control Input. DRN is the drain of the internal high-voltage p-channel MOSFET connected to GON. See the <i>High-Voltage Switch Control</i> section for details.
22	THR	GON Falling Regulation Adjustment Input. Connect THR to the center of a resistive voltage-divider between a reference supply and GND to adjust the GON falling regulation set point. CTL and MODE allow GON to disconnect from SRC and be discharged through DRN; discharge stops when GON reaches $10 \times V_{THR}$. See the <i>High-Voltage Switch Control</i> section for details.
23	FB2	Step-Up Regulator Feedback Input. Connect FB2 to the center of a resistive voltage-divider between the step-up regulator output and GND to set the step-up regulator output voltage. Place the resistive voltage-divider close to FB2.
24	FBN	Negative Charge-Pump Regulator Feedback Input. Connect FBN to the center of a resistive voltage-divider between the negative output and REF to set the negative charge-pump regulator output voltage. Place the resistive voltage-divider close to FBN.
25	GND2	Step-Down Regulator Power Ground
26	LX2	Step-Up Regulator Switching Node. Connect the inductor and the Schottky diode to LX2 and minimize the trace area for low EMI.
27	GATE	Input MOSFET Gate-Driver Output. GATE controls an external p-channel MOSFET between the input voltage and the step-up regulator's inductor. The switch is off when the step-up regulator is turned off, so that the regulator's output discharges to ground. During startup, the step-up regulator's soft-start begins when V_{GATE} falls below the GATE done threshold.
28	EN	Enable Input. Pulling EN high or leaving EN unconnected enables the step-up regulator and the negative charge pump. Connecting EN to GND disables the above blocks and puts the step-down regulator in skip mode. EN sources $5\mu\text{A}$ to allow a capacitor-controlled startup delay.
29	MODE	High-Voltage Switch-Control Block Mode Selection Input and Timing-Adjustment Input. See the <i>High-Voltage Switch Control</i> section for details.
30	DEL	Positive Charge-Pump Regulator and High-Voltage Switch-Control Delay Input. Connect a capacitor between DEL and GND to set the delay time. A $5\mu\text{A}$ current source charges C_{DEL} . DEL is internally pulled to GND through a 20Ω internal resistor in shutdown.
31	COMP	Step-Up Regulator Error Amplifier Compensation Pin. See the <i>Loop Compensation</i> section for details.
32	FB1	Step-Down Regulator Feedback Input. Connect FB1 to the center of a resistive voltage-divider between the step-down regulator output and GND to set the step-down regulator output voltage.
—	EP	Exposed Pad. Connect the exposed backside pad to GND and provide adequate thermal path to cool the IC. See the <i>PC Board Layout and Grounding</i> section.

Low-Cost, Multiple-Output Power Supply for LCD Monitors/TVs

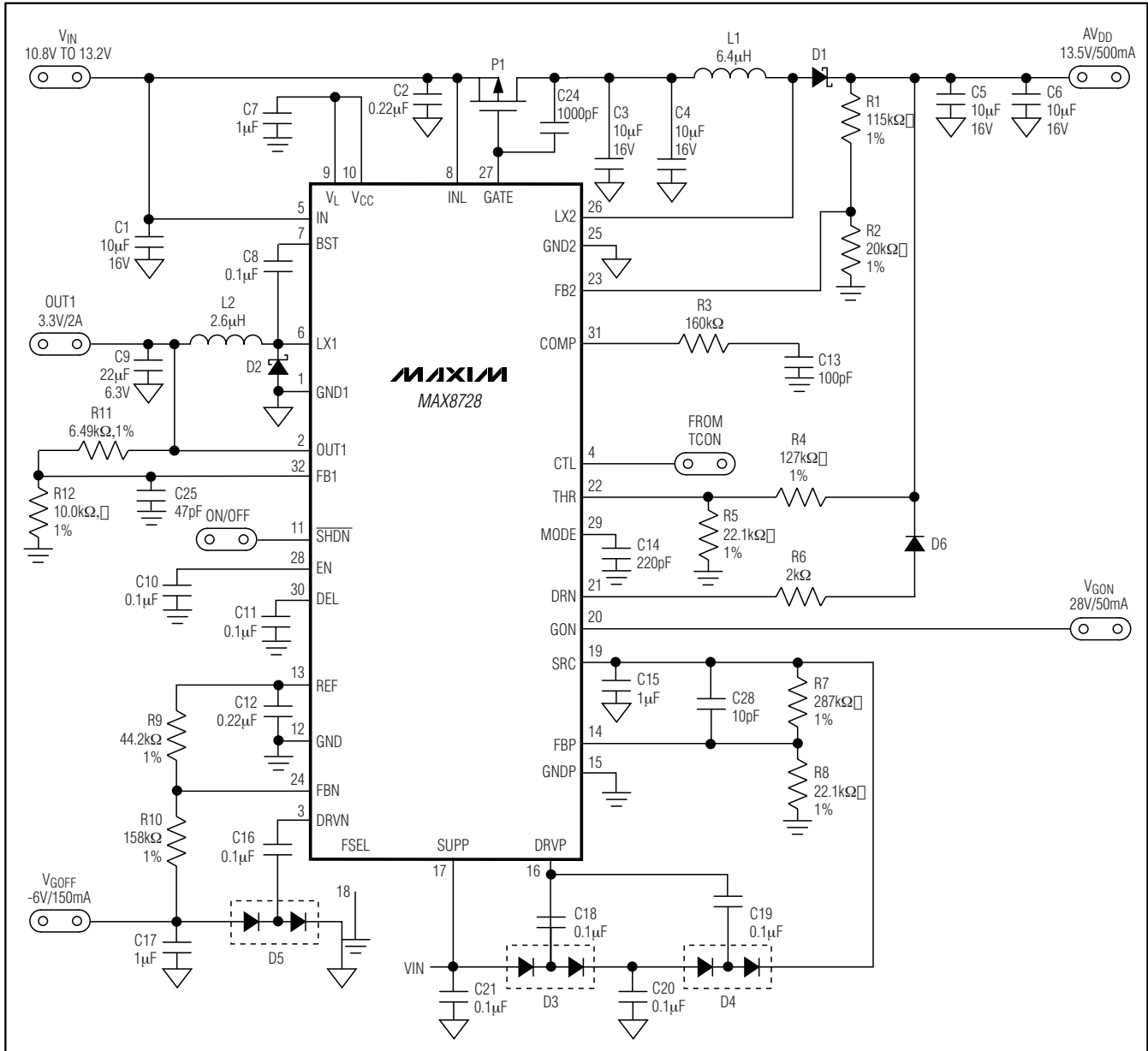

Figure 1. Typical Operating Circuit

Low-Cost, Multiple-Output Power Supply for LCD Monitors/TVs

Typical Operating Circuit

The typical operating circuit (Figure 1) of the MAX8728 is a complete power-supply system for TFT LCD panels in monitors and TVs. The circuit generates a +3.3V logic supply, a +13.5V source driver supply, a +28V positive gate driver supply, and a -6V negative gate driver supply from a 12V \pm 10% input supply and operates at 1.5MHz. Table 1 lists some selected components and Table 2 lists the contact information for component suppliers.

Detailed Description

The MAX8728 is a multiple-output power supply designed primarily for TFT LCD panels used in monitors and TVs. It contains a step-down switching regulator to generate the logic supply rail, a step-up switching regulator to generate the source driver supply, and two charge-pump regulators to generate the gate-driver supplies. Each regulator features adjustable output voltage, digital soft-start, and timer-delayed fault protection. Both the step-down and step-up regulators use fixed-frequency current-mode control architectures. The two switching regulators are 180° out of phase to minimize the input ripple. The internal oscillator offers three pin-selectable frequency options (500kHz/1MHz/1.5MHz) allowing users to optimize their designs based on the specific application requirements. In addition, the MAX8728 features a high-voltage switch-control block, an internal 5V linear regulator, a 2V reference output, well-defined power-up and power-down sequences, and thermal-overload protection. Figure 2 shows the MAX8728 functional diagram.

Step-Down Regulator

The step-down regulator consists of an internal n-channel MOSFET with gate driver, a lossless current-sense network, a current-limit comparator, and a PWM controller block. The external power stage consists of a Schottky diode rectifier, an inductor, and output capacitors. The output voltage is regulated by changing the duty cycle of the high-side MOSFET. A bootstrap circuit that uses a 0.1 μ F flying capacitor between LX1 and BST provides the supply voltage for the high-side gate driver. Although the MAX8728 also includes a 25 Ω (typ) low-side MOSFET, this switch is used to charge the bootstrap capacitor during startup and maintains fixed-frequency operation at light load and cannot be used as a synchronous rectifier. An external Schottky diode (D2 in Figure 1) is always required.

PWM Controller Block

The heart of the PWM control block is a multi-input, open-loop comparator that sums three signals: the out-

Table 1. Component List (1.5MHz)

DESIGNATION	DESCRIPTION
C1, C3, C4, C5, C6	10 μ F \pm 20%, 16V X5R ceramic capacitors (1206) TDK C3216X5R1C106M
D1, D2	3A, 30V Schottky diode (M-flat) Toshiba CMS02 (top mark S2)
D3, D4, D5	220mA, 100V dual diode (SOT23) Fairchild MMBD4148SE (top mark D4)
L1	6.4 μ H, 1.5ADC inductor Sumida CDRH6D12-6R4
L2	2.6 μ H, 2.6ADC inductor Sumida CDRH6D12-2R6
P1	2.4A, -20V p-channel MOSFET (3-pin SuperSOT) Fairchild FDN304P (top mark 304)

Table 2. Component Suppliers

SUPPLIER	PHONE
Fairchild Semiconductor	408-822-2000
Sumida	847-545-6700
TDK	847-803-6100
Toshiba	949-455-2000

put voltage signal with respect to the reference voltage, the current-sense signal, and the slope compensation. The PWM controller is a direct-summing type, lacking a traditional error amplifier and the phase shift associated with it. This direct-summing configuration approaches ideal cycle-by-cycle control over the output voltage.

When EN is high or floating, the controller always operates in fixed-frequency PWM mode. Each pulse from the oscillator sets the main PWM latch that turns on the high-side switch until the PWM comparator changes state. As the high-side switch turns off, the low-side switch turns on. The low-side switch stays on until the beginning of the next clock cycle.

When EN is low, the controller operates in skip mode. The skip mode dramatically improves light-load efficiency by reducing the effective frequency, which reduces switching losses. It keeps the actual peak inductor current at about 0.8A in an active cycle, allowing subsequent cycles to be skipped. Skip mode transitions seamlessly to fixed-frequency PWM operation as load current increases.

Low-Cost, Multiple-Output Power Supply for LCD Monitors/TVs

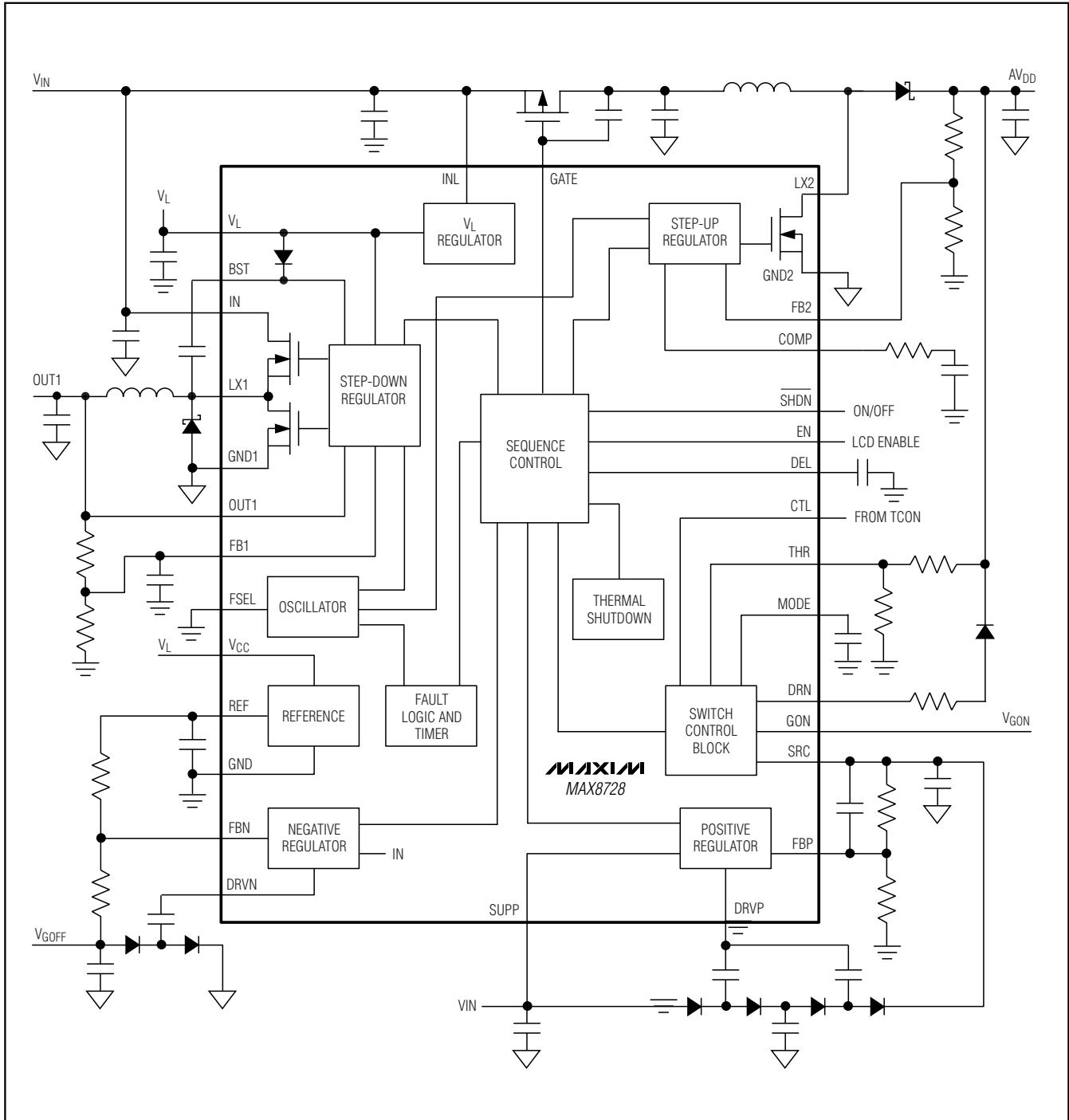

Figure 2. Functional Diagram

Low-Cost, Multiple-Output Power Supply for LCD Monitors/TVs

Current Limiting and Lossless Current Sensing

The current-limit circuit turns off the high-side MOSFET switch whenever the voltage across the high-side MOSFET exceeds an internal threshold corresponding to the actual current limit of $2.8A \pm 10\%$.

For current-mode control, an internal lossless sense network derives a current-sense signal from the inductor DC resistance. The time constant of the current-sense network is not required to match the time constant of the inductor and has been chosen to provide sufficient current-ramp signal for stable operation at each operating frequency. The current-sense signal is AC-coupled into the PWM comparator, eliminating most DC output voltage variation with load current.

Low-Frequency Operation

The step-down regulator of the MAX8728 enters into low-frequency operating mode if the voltage on OUT1 is below 1.3V. In the low-frequency mode, the switching frequency of the step-down regulator is 1/6 the oscillator frequency. This feature prevents potentially uncontrolled inductor current if OUT1 is overloaded or shorted to ground.

Soft-Start and Fault Protection

The step-down regulator includes a 7-bit soft-start DAC that steps the internal reference voltage from zero to 2V in 128 steps. The soft-start period is 3ms (typ) and FB1 fault detection is disabled during this period. The soft-start feature effectively limits the inrush current during startup (see the Step-Down Regulator Soft-Start Waveforms in the *Typical Operating Characteristics*). The MAX8728 monitors OUT1 (fixed-output mode) or FB1 (adjustable-output mode) for undervoltage conditions. If the voltage is continuously below 80% (typ) of the nominal regulation point for approximately 50ms, the MAX8728 sets a fault latch, shutting down all outputs except VL and REF.

Step-Up Regulator

The step-up regulator employs a current-mode, fixed-frequency PWM architecture to maximize loop bandwidth and provide fast transient response to pulsed loads typical of TFT LCD panel source drivers. The integrated MOSFET and the built-in digital soft-start function reduce the number of external components required while controlling inrush currents. The output voltage can be set from $V_{IN} - 28V$ with an external resistive voltage-divider. The regulator controls the output voltage and the power delivered to the output by modulating the duty cycle of the internal power MOSFET in each switching cycle.

PWM Controller Block

An error amplifier compares the signal at FB2 to 2.0V and changes the COMP output. The voltage at COMP sets the peak inductor current. As the load varies, the error amplifier sources or sinks current to the COMP output accordingly to produce the inductor peak current necessary to service the load. To maintain stability at high duty cycles, a slope-compensation signal is summed with the current-sense signal.

On the rising edge of the internal clock, the controller sets a flip-flop, turning on the n-channel MOSFET and applying the input voltage across the inductor. The current through the inductor ramps up linearly, storing energy in its magnetic field. Once the sum of the current-feedback signal and the slope compensation exceed the COMP voltage, the controller resets the flip-flop and turns off the MOSFET. Since the inductor current is continuous, a transverse potential develops across the inductor that turns on the diode (D1). The voltage across the inductor then becomes the difference between the output voltage and the input voltage. This discharge condition forces the current through the inductor to ramp back down, transferring the energy stored in the magnetic field to the output capacitor and the load. The MOSFET remains off for the rest of the clock cycle.

Input Switch Control

The GATE pin of the MAX8728 controls an optional external p-channel MOSFET between the input supply and the inductor of the step-up regulator. This function disconnects the step-up regulator from the input supply and allows the regulator output to discharge to ground when the step-up regulator is disabled. When EN is low, GATE is internally pulled up to the input supply through a 1k Ω resistor. Once EN and \overline{SHDN} are high and the negative charge-pump regulator is in regulation, the MAX8728 starts pulling down GATE with an 11 μA internal current source. The external p-channel MOSFET turns on and connects the input supply to the step-regulator when V_{GATE} falls below the turn-on threshold of the MOSFET. When V_{GATE} reaches $V_{IN} - 4V$, the step-up regulator is enabled and initiates a soft-start routine. V_{GATE} continues to fall until it reaches $V_{IN} - 5V$.

Soft-Start and Fault Protection

The step-up regulator achieves soft-start by linearly ramping up its internal current limit. The soft-start terminates when the output reaches regulation or the full current limit has been reached. The current limit rises from zero to the full current limit in approximately 3ms.

Low-Cost, Multiple-Output Power Supply for LCD Monitors/TVs

The soft-start feature effectively limits the inrush current during startup (see the Step-Up Regulator Soft-Start Waveforms in the *Typical Operating Characteristics*). The MAX8728 monitors FB2 for undervoltage conditions. If the voltage is continuously below 90% of the nominal regulation point for approximately 50ms, the MAX8728 sets a fault latch, shutting down all outputs except VL, REF, and the step-down regulator.

Positive Charge-Pump Regulator

The positive charge-pump regulator is typically used to generate the positive supply rail for the TFT LCD gate-driver ICs. The output voltage is set with an external resistive voltage-divider from its output to GND with the midpoint connected to FBP. The number of charge-pump stages and the setting of the feedback divider determine the output voltage of the positive charge-pump regulator. The charge pump includes a high-side, p-channel MOSFET (P1) and a low-side, n-channel MOSFET (N1) to control the power transfer as shown in Figure 3.

The error comparator compares the feedback signal (FBP) with a 2.0V internal reference. If the feedback signal is below the reference, the charge-pump regulator turns on P1 and turns off N1 when the rising edge of the oscillator clock arrives, level shifting the flying capacitors (C18 and C19) by V_{SUPP} volts. If the resulting voltage on C18 and C19 is greater than their asso-

ciated reservoir capacitors (C20 and C15), charge flows until the diode connecting each flying capacitor to its reservoir capacitor turns off. The falling edge of the oscillator clock turns off P1 and turns on N1, charging the flying capacitors (C18 and C19) through the diodes that connect them to the reservoir capacitors (C21 and C20). If the feedback signal is above the reference when the rising edge of the oscillator comes, the regulator ignores this clock edge and keeps N1 on and P1 off.

The positive charge-pump regulator's startup can be delayed by connecting an external capacitor from DEL to GND. An internal constant-current source begins charging the DEL capacitor when EN and \overline{SHDN} are logic high, the negative charge pump reaches regulation, and GATE has gone low. When the DEL voltage exceeds $V_{REF}/2$, the positive charge-pump regulator is enabled. Each time it is enabled, the positive charge-pump regulator goes through a soft-start routine by ramping up its internal reference voltage from 0 to 2V in 128 steps. The soft-start period is 3ms (typ) and FBP fault detection is disabled during this period. The soft-start feature effectively limits the inrush current during startup. The MAX8728 also monitors the FBP voltage for undervoltage conditions. If VFBP is continuously below 80% of its nominal regulation point for approximately 50ms, the MAX8728 sets a fault latch, shutting down all outputs except VL, REF, and the step-down regulator.

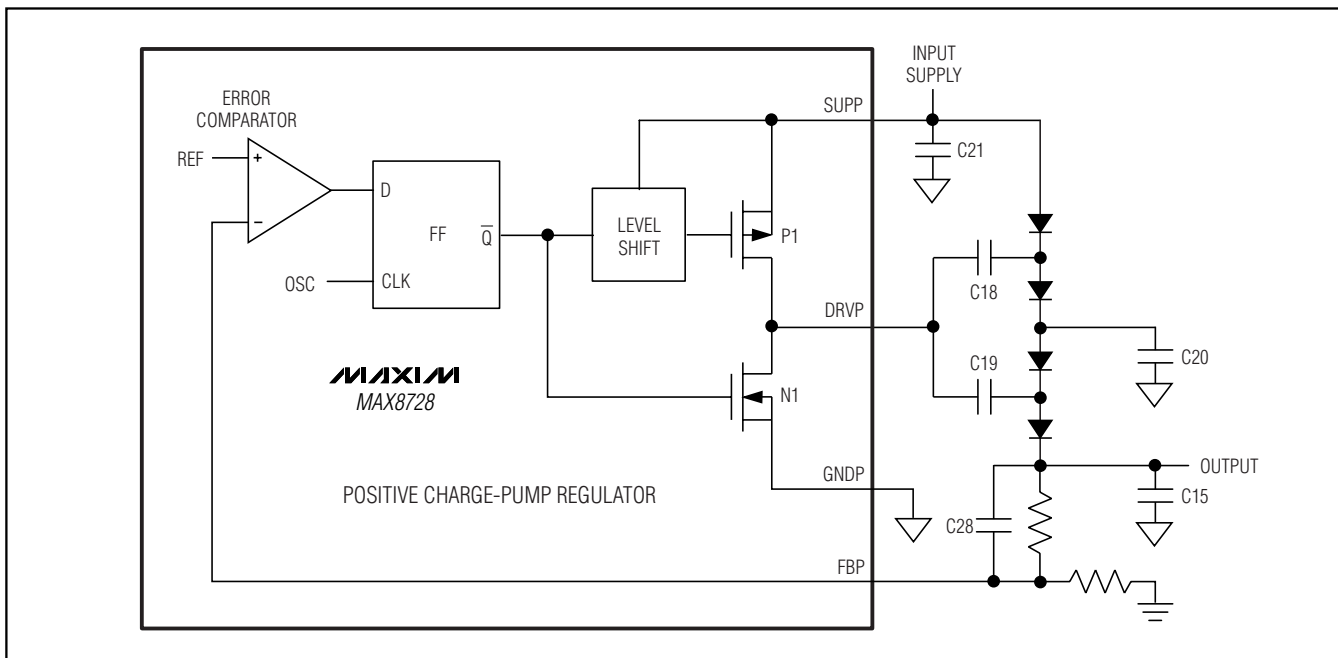

Figure 3. Positive Charge-Pump Regulator Block Diagram

Low-Cost, Multiple-Output Power Supply for LCD Monitors/TVs

Negative Charge-Pump Regulator

The negative charge-pump regulator is typically used to generate the negative supply rail for the TFT LCD gate-driver ICs. The output voltage is set with an external resistive voltage-divider from its output to REF with the midpoint connected to FBN. The number of charge-pump stages and the setting of the feedback-divider determine the output of the negative charge-pump regulator. The charge-pump controller includes a high-side, p-channel MOSFET (P2) and a low-side, n-channel MOSFET (N2) to control the power transfer as shown in Figure 4.

The error comparator compares the feedback signal (FBN) with a 250mV internal reference. If the feedback signal is above the reference, the charge-pump regulator turns on N2 and turns off P2 when the rising edge of the oscillator clock arrives, level shifting the flying capacitor (C16). The falling edge of the oscillator clock turns off N2 and turns on P2, charging the flying capacitor (C16) through the diode that connects it to the reservoir capacitor (C1). If the feedback signal is below the reference (output is in regulation) when the rising edge of the oscillator comes, the regulator ignores this clock edge and keeps P2 on and N2 off.

The negative charge-pump regulator is enabled when SHDN and EN are logic high and the step-down regulator reaches regulation. Each time it is enabled, the negative charge-pump regulator goes through a soft-start routine by ramping down its internal reference voltage from 2V to 250mV in 128 steps. The soft-start period is 3ms (typ) and FBN fault detection is disabled during this period. The soft-start feature effectively limits the inrush current during startup. The MAX8728 also monitors the FBN voltage for undervoltage conditions. If VFBN is continuously above 600mV for approximately 50ms, the MAX8728 sets a fault latch, shutting down all outputs except VL, REF, and the step-down regulator.

High-Voltage Switch Control

The MAX8728's high-voltage switch control block (Figure 5) consists of two high-voltage, p-channel MOSFETs: Q1, between SRC and GON and Q2, between GON and DRN. The switch control block is enabled when VDEL goes above $V_{REF} / 2$. Q1 and Q2 are controlled by CTL and MODE. There are two different modes of operation (see the *Typical Operating Characteristics* section).

Activate the first mode by connecting MODE to REF. When CTL is logic high, Q1 turns on and Q2 turns off, connecting GON to SRC. When CTL is logic low, Q1

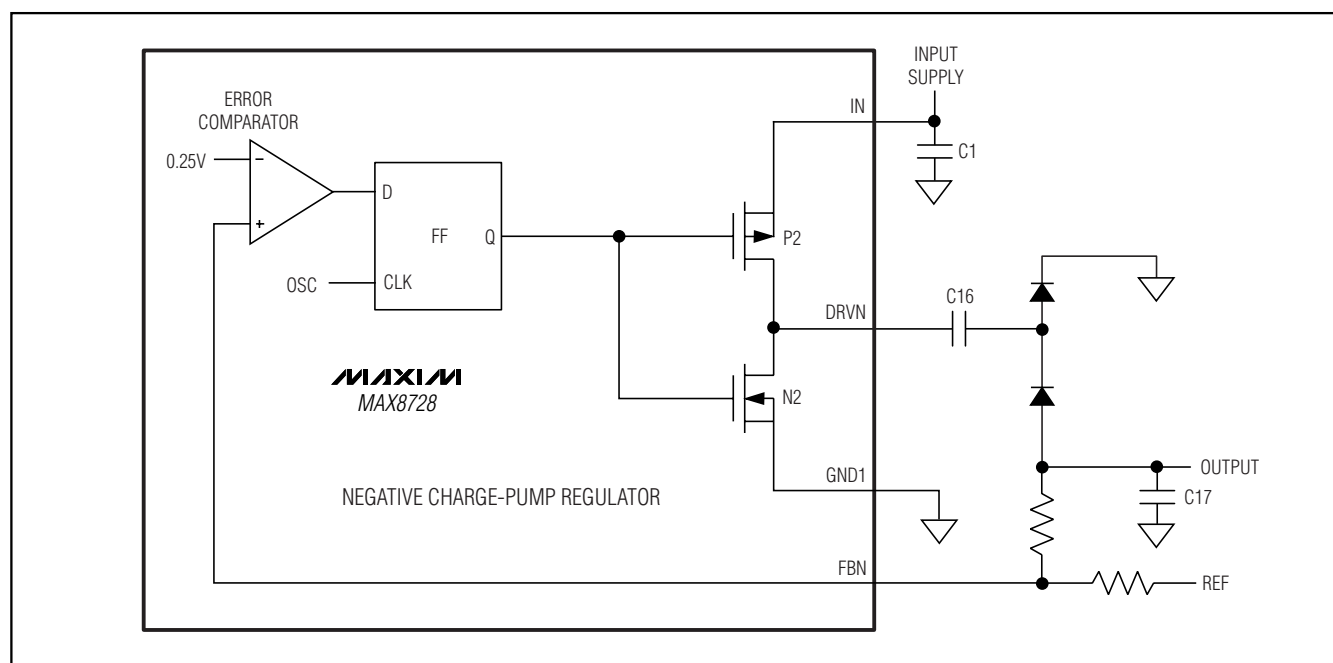

Figure 4. Negative Charge-Pump Regulator Block Diagram

Low-Cost, Multiple-Output Power Supply for LCD Monitors/TVs

turns off and Q2 turns on, connecting GON to DRN. GON can then be discharged through a resistor connected between DRN and GND or AV_{DD}. Q2 turns off and stops discharging GON when V_{GON} reaches 10 times the voltage on THR.

When V_{MODE} is less than 0.9 × V_{REF}, the switch control block works in the second mode. The rising edge of V_{CTL} turns on Q1 and turns off Q2, connecting GON to SRC. An internal n-channel MOSFET Q3 between MODE and GND is also turned on to discharge an external capacitor between MODE and GND. The falling edge of V_{CTL} turns off Q3, and an internal 50μA current source starts charging the MODE capacitor. Once V_{MODE} exceeds 0.5 × V_{REF}, the switch control block turns off Q1 and turns on Q2, connecting GON to DRN. GON can then be discharged through a resistor connected between DRN and GND or AV_{DD}. Q2 turns off and stops discharging GON when V_{GON} reaches 10 times the voltage on THR.

When the LCD is shut down or in a fault state, the switch control block is disabled, DZL is held low, and GON is discharged to GND through an internal 4mA current source. If the DRN resistor connects DRN to AV_{DD} or another voltage above ground, the Q2 body diode conducts. To prevent the body diode conduction, an external diode must be added in series with the DRN resistor (D6 in Figure 1). During startup, the 4mA current source and Q4 are released when GATE reaches the GATE DONE threshold.

Linear Regulator (VL)

The MAX8728 includes an internal linear regulator. INL is the input of the linear regulator. The input voltage range is between 7V and 13.2V. The output voltage is set to 5V. The regulator powers the internal MOSFET drivers, PWM controllers, charge-pump regulators, and logic circuitry. The total external load capability is 25mA. Bypass VL to GND with a minimum 1μF ceramic capacitor.

Reference Voltage (REF)

The reference output is nominally 2V, and can source at least 50μA (see the *Typical Operating Characteristics* section). V_{CC} is the input of the internal reference block. Bypass REF with a 0.22μF ceramic capacitor connected between REF and GND.

Frequency Selection (FSEL)

The step-down regulator and step-up regulator use the same internal oscillator. The FSEL input selects the switching frequency. Table 3 shows the switching frequency based on the FSEL connection. High-frequency (1.5MHz) operation optimizes the application for the

smallest component size, trading off efficiency due to higher switching losses. Low-frequency (500kHz) operation offers the best overall efficiency at the expense of component size and board space.

To reduce the input RMS current, the step-down regulator and the step-up regulator operate 180° out of phase from each other. The feature allows the use of less input capacitance.

Power-Up Sequence

The step-down regulator starts up when the MAX8728's internal reference voltage (REF) is above its undervoltage lockout (UVLO) threshold and SHDN is logic high. The FB1 fault-detection circuit is enabled after the step-down regulator reaches regulation. The negative charge-pump regulator starts up when both EN and SHDN are logic high and REF is above its UVLO threshold. Once the negative charge-pump regulator output is in regulation, the MAX8728 enables the FBN fault-detection circuit and the input-switch control block, which starts pulling down GATE with a 11μA internal current source. The external p-channel MOSFET turns on and connects the input supply to the step-up regulator when VGATE falls below the turn-on threshold of the MOSFET.

When VGATE reaches the GATE DONE threshold, the MAX8728 enables the step-up regulator and the positive charge-pump adjustable delay block. The FB2 fault-detection circuit is enabled after the step-up regulator reaches regulation. The delay block charges the DEL capacitor with an internal 5μA current source and V_{DEL} rises linearly. When V_{DEL} exceeds 1V (typ), the MAX8728 enables the positive charge-pump regulator and the high-voltage switch control block. The FBP fault detection is enabled after the positive charge-pump regulator reaches regulation.

Power-Down Control

The MAX8728 disables the step-up regulator, positive charge-pump regulator, negative charge-pump regulator, input switch control block, delay block, and high-voltage switch control block when EN or SHDN is logic low, or when any fault latch is set. The step-down regulator is disabled only when SHDN is logic low, the step-down fault latch is set, or during thermal overload.

Table 3. Frequency Selection

FSEL	SWITCHING FREQUENCY (kHz)
GND	1500
VCC	1000
REF	500

Low-Cost, Multiple-Output Power Supply for LCD Monitors/TVs

Fault Protection

During steady-state operation, if any output of the four regulators (step-down regulator, step-up regulator, positive charge-pump regulator, and negative charge-pump regulator) does not exceed its respective fault-detection threshold, the MAX8728 activates an internal fault timer. If any condition or the combination of conditions indicates a continuous fault for the fault-timer duration (50ms typ), the MAX8728 sets a fault latch. If the fault is caused by the step-up regulator or one of the charge pumps (LCD fault), the MAX8728 shuts down all the outputs except VL, REF, and the step-down regulator. Once the fault condition is removed, toggle EN or SHDN, or cycle the input voltage to clear the LCD fault latch and restart the LCD supplies. If the fault is caused by the step-down regulator, the MAX8728 shuts down all the outputs except VL and REF. Once the fault condition is removed, toggle SHDN or cycle the input voltage to clear the step-down fault latch and restart the supplies.

Thermal-Overload Protection

The thermal-overload protection prevents excessive power dissipation from overheating the MAX8728. When the junction temperature exceeds $T_J = +160^\circ\text{C}$, a thermal sensor immediately activates the fault protection, which shuts down all the outputs except the reference, allowing the device to cool down. Once the device cools down by approximately 15°C , the MAX8728 automatically restarts all the supplies.

The thermal-overload protection protects the controller in the event of fault conditions. For continuous operation, do not exceed the absolute maximum junction temperature rating of $T_J = +150^\circ\text{C}$.

Design Procedure

Step-Down Regulator Design

Inductor Selection

Three key inductor parameters must be specified: inductance value (L), peak current (I_{PEAK}), and DC resistance (R_{DC}). The following equation includes a constant, LIR, which is the ratio of peak-to-peak inductor ripple current to DC load current. A higher LIR value allows smaller inductance, but results in higher losses and higher ripple. A good compromise between size and losses is typically found at a 30% ripple-current to load-current ratio (LIR = 0.3), which corresponds to a peak inductor current 1.15 times the DC load current:

$$L_{OUT1} = \frac{V_{OUT1} \times (V_{IN} - V_{OUT1})}{V_{IN} \times f_{SW} \times I_{OUT1(MAX)} \times LIR}$$

where $I_{OUT1(MAX)}$ is the maximum DC load current, and the switching frequency f_{SW} is 1.5MHz when FSEL is tied to GND, 1MHz when FSEL is tied to V_{CC} , and 500kHz when FSEL is tied to REF. The exact inductor value is not critical and can be adjusted to make trade-offs among size, cost, and efficiency. Lower inductor values minimize size and cost, but they also increase the output ripple and reduce the efficiency due to higher peak currents. On the other hand, higher inductor values increase efficiency, but at some point resistive losses due to extra turns of wire will exceed the benefit gained from lower AC current levels.

The inductor's saturation current must exceed the peak inductor current. The peak current can be calculated by:

$$I_{OUT1_RIPPLE} = \frac{V_{OUT1} \times (V_{IN} - V_{OUT1})}{f_{SW} \times L_{OUT1} \times V_{IN}}$$

$$I_{OUT1_PEAK} = I_{OUT1(MAX)} + \frac{I_{OUT1_RIPPLE}}{2}$$

The inductor's DC resistance should be low for good efficiency. Find a low-loss inductor having the lowest possible DC resistance that fits in the allotted dimensions. Ferrite cores are usually the best choice, especially at the higher frequency settings. Shielded-core geometries help keep noise, EMI, and switching waveform jitter low.

Input Capacitors

The input filter capacitors reduce peak currents drawn from the power source and reduce noise and voltage ripple on the input caused by the regulator's switching. They are usually selected according to input ripple current requirements and voltage rating, rather than capacitance value. The input voltage and load current determine the RMS input ripple current (I_{RMS}):

$$I_{RMS} = I_{OUT1} \times \frac{\sqrt{V_{OUT1} \times (V_{IN} - V_{OUT1})}}{V_{IN}}$$

The worst case is $I_{RMS} = 0.5 \times I_{OUT1}$, which occurs at $V_{IN} = 2 \times V_{OUT1}$.

For most applications, ceramic capacitors are used because of their high ripple current and surge-current capabilities. For optimal circuit long-term reliability, choose an input capacitor that exhibits less than $+10^\circ\text{C}$ temperature rise at the RMS input current corresponding to the maximum load current.

Low-Cost, Multiple-Output Power Supply for LCD Monitors/TVs

Output-Capacitor Selection

Since the MAX8728's step-down regulator is internally compensated, it is stable with any reasonable amount of output capacitance. However, the actual capacitance and equivalent series resistance (ESR) affect the regulator's output ripple voltage and transient response. The rest of this section deals with how to determine the output capacitance and ESR needs according to the ripple voltage and load-transient requirements.

The output voltage ripple has two components: variations in the charge stored in the output capacitor, and the voltage drop across the capacitor's ESR caused by the current into and out of the capacitor:

$$\begin{aligned} V_{OUT1_RIPPLE} &= V_{OUT1_RIPPLE(ESR)} + V_{OUT1_RIPPLE(C)} \\ V_{OUT1_RIPPLE(ESR)} &= I_{OUT1_RIPPLE} \times R_{ESR_OUT1} \\ V_{OUT1_RIPPLE(C)} &= \frac{I_{OUT1_RIPPLE}}{8 \times C_{OUT1} \times f_{SW}} \end{aligned}$$

where I_{OUT1_RIPPLE} is defined in the *Step-Down Regulator, Inductor Selection* section, C_{OUT1} is output capacitance, and R_{ESR_OUT1} is the ESR of output capacitor C_{OUT1} . In Figure 1's circuit, the inductor ripple current is 0.6A. If the voltage ripple requirement of Figure 1's circuit is $\pm 1\%$ of the 3.3V output, then the total peak-to-peak ripple voltage should be less than 66mV. Assuming that the ESR ripple and the capacitive ripple each should be less than 50% of the total peak-to-peak ripple, then the ESR should be less than 55m Ω and the output capacitance should be more than 1.5 μ F to meet the total ripple requirement. A 22 μ F capacitor with ESR (including PC board trace resistance) of 10m Ω is selected for the standard application circuit in Figure 1, which easily meets the voltage-ripple requirement.

The step-down regulator's output capacitor and ESR also affect the voltage undershoot and overshoot when the load steps up and down abruptly. The undershoot and overshoot also have two components: the voltage steps caused by ESR and voltage sag and soar due to the finite capacitance and inductor slew rate. Use the following formulae to check if the ESR is low enough and the output capacitance is large enough to prevent excessive soar and sag.

The amplitude of the ESR step is a function of the load step and the ESR of the output capacitor:

$$V_{OUT1_ESR_STEP} = \Delta I_{OUT1} \times R_{ESR_OUT1}$$

The amplitude of the capacitive sag is a function of the load step, the output capacitor value, the inductor

value, the input-to-output voltage differential, and the maximum duty cycle:

$$V_{OUT1_SAG} = \frac{L_{OUT1} \times (\Delta I_{OUT1})^2}{2 \times C_{OUT1} \times (V_{IN(MIN)} \times D_{MAX} - V_{OUT1})}$$

The amplitude of the capacitive soar is a function of the load step, the output capacitor value, the inductor value and the output voltage:

$$V_{OUT1_SOAR} = \frac{L_{OUT1} \times (\Delta I_{OUT1})^2}{2 \times C_{OUT1} \times V_{OUT1}}$$

Given the component values in the circuit of Figure 1, during a 2A step-load transient, the voltage step due to capacitor ESR is negligible. The voltage sag and soar are 40.2mV and 71.6mV, respectively.

Rectifier Diode

The MAX8728's high switching frequency demands a high-speed rectifier. Schottky diodes are recommended for most applications because of their fast recovery time and low forward voltage. In general, a 2A Schottky diode works well in the MAX8728's step-down regulator.

Output-Voltage Selection

Connect a resistive voltage-divider between OUT1 and GND with the center tap connected to FB1 to adjust the output voltage. Choose R12 (resistance from FB1 to GND) to be between 5k Ω and 50k Ω , and solve for R11 (resistance from OUT1 to FB1) using the equation:

$$R11 = R12 \times \left(\frac{V_{OUT1}}{V_{FB1}} - 1 \right)$$

where $V_{FB1} = 2V$, and V_{OUT1} may vary from 2V to 3.6V. Connecting a small capacitor (e.g., 47pF) between FB1 and GND reduces FB1 noise sensitivity.

Step-Up Regulator Design

Inductor Selection

The inductance value, peak-current rating, and series resistance are factors to consider when selecting the step-up inductor. These factors influence the converter's efficiency, maximum output load capability, transient response time, and output voltage ripple. Physical size and cost are also important factors to be considered.

The maximum output current, input voltage, output voltage, and switching frequency determine the inductor value. Very high inductance values minimize the cur-

Low-Cost, Multiple-Output Power Supply for LCD Monitors/TVs

rent ripple and therefore reduce the peak current, which decreases core losses in the inductor and I^2R losses in the entire power path. However, large inductor values also require more energy storage and more turns of wire, which increase physical size and can increase I^2R losses in the inductor. Low inductance values decrease the physical size but increase the current ripple and peak current. Finding the best inductor involves choosing the best compromise between circuit efficiency, inductor size, and cost.

The equations used here include a constant LIR, which is the ratio of the inductor peak-to-peak ripple current to the average DC inductor current at the full load current. The best trade-off between inductor size and circuit efficiency for step-up regulators generally has an LIR between 0.2 and 0.5. However, depending on the AC characteristics of the inductor core material and ratio of inductor resistance to other power-path resistances, the best LIR can shift up or down. If the inductor resistance is relatively high, more ripple can be accepted to reduce the number of turns required and increase the wire diameter. If the inductor resistance is relatively low, increasing inductance to lower the peak current can decrease losses throughout the power path. If extremely thin, high-resistance inductors are used, as is common for LCD panel applications, the best LIR can increase to between 0.5 and 1.0.

Once a physical inductor is chosen, higher and lower values of the inductor should be evaluated for efficiency improvements in typical operating regions.

Calculate the approximate inductor value using the typical input voltage (V_{IN}), the maximum output current ($I_{AVDD(MAX)}$), the expected efficiency (η_{TYP}) taken from an appropriate curve in the *Typical Operating Characteristics*, and an estimate of LIR based on the above discussion:

$$L_{AVDD} = \left(\frac{V_{IN}}{V_{AVDD}} \right)^2 \left(\frac{V_{AVDD} - V_{IN}}{I_{AVDD(MAX)} \times f_{SW}} \right) \left(\frac{\eta_{TYP}}{LIR} \right)$$

Choose an available inductor value from an appropriate inductor family. Calculate the maximum DC input current at the minimum input voltage $V_{IN(MIN)}$ using conservation of energy and the expected efficiency at that operating point (η_{MIN}) taken from an appropriate curve in the *Typical Operating Characteristics*:

$$I_{IN(DC,MAX)} = \frac{I_{AVDD(MAX)} \times V_{AVDD}}{V_{IN(MIN)} \times \eta_{MIN}}$$

Calculate the ripple current at that operating point and the peak current required for the inductor:

$$I_{AVDD_RIPPLE} = \frac{V_{IN(MIN)} \times (V_{AVDD} - V_{IN(MIN)})}{L_{AVDD} \times V_{AVDD} \times f_{SW}}$$

$$I_{AVDD_PEAK} = I_{IN(DC,MAX)} + \frac{I_{AVDD_RIPPLE}}{2}$$

The inductor's saturation current rating and the MAX8728's LX2 current limit should exceed I_{AVDD_PEAK} and the inductor's DC current rating should exceed $I_{IN(DC,MAX)}$. For good efficiency, choose an inductor with less than 0.1Ω series resistance.

Considering the *Typical Operating Circuit* in Figure 1, the maximum load current ($I_{AVDD(MAX)}$) is 500mA with a 13.5V output and a typical input voltage of 12V. Choosing an LIR of 0.3 and estimating efficiency of 95% at this operating point:

$$L_{AVDD} = \left(\frac{12V}{13.5V} \right)^2 \left(\frac{13.5V - 12V}{0.5A \times 1.5MHz} \right) \left(\frac{0.95}{0.5} \right) \approx 6.4\mu H$$

Using the circuit's minimum input voltage (10.8V) and estimating efficiency of 90% at that operating point:

$$I_{IN(DC,MAX)} = \frac{0.5A \times 13.5V}{10.8V \times 0.9} \approx 0.69A$$

The ripple current and the peak current are:

$$I_{RIPPLE} = \frac{10.8V \times (13.5V - 10.8V)}{6.4\mu H \times 13.5V \times 1.5MHz} \approx 0.23A$$

$$I_{PEAK} = 0.69A + \frac{0.23A}{2} \approx 0.81A$$

Output-Capacitor Selection

The total output voltage ripple has two components: the capacitive ripple caused by the charging and discharging of the output capacitance, and the ohmic ripple due to the capacitor's ESR:

$$V_{AVDD_RIPPLE} = V_{AVDD_RIPPLE(C)} + V_{AVDD_RIPPLE(ESR)}$$

$$V_{AVDD_RIPPLE(C)} \approx \frac{I_{AVDD}}{C_{AVDD}} \left(\frac{V_{AVDD} - V_{IN}}{V_{AVDD} \times f_{SW}} \right), \text{ and}$$

$$V_{AVDD_RIPPLE(ESR)} \approx I_{AVDD_PEAK} \times R_{ESR}$$

where I_{AVDD_PEAK} is the peak-inductor current (see the *Inductor Selection* section). For ceramic capacitors, the

Low-Cost, Multiple-Output Power Supply for LCD Monitors/TVs

output voltage ripple is typically dominated by $V_{AVDD_RIPPLE(C)}$. The voltage rating and temperature characteristics of the output capacitor must also be considered.

Input-Capacitor Selection

The input capacitor reduces the current peaks drawn from the input supply and reduces noise injection into the IC. Two 10 μ F ceramic capacitors are used in the *Typical Applications Circuit* (Figure 1) because of the high-source impedance seen in typical lab setups. Actual applications usually have much lower source impedance since the step-up regulator often runs directly from the output of another regulated supply. Typically, the input capacitance can be reduced below the values used in the *Typical Operating Circuit*.

Rectifier Diode

The MAX8728's high-switching frequency demands a high-speed rectifier. Schottky diodes are recommended for most applications because of their fast recovery time and low forward voltage. In general, a 1A to 2A Schottky diode complements the internal MOSFET well.

Output-Voltage Selection

The output voltage of the step-up regulator is adjusted by connecting a resistive voltage-divider from the output (V_{AVDD}) to GND with the center tap connected to FB2 (see Figure 1). Select R2 in the 10k Ω to 50k Ω range. Calculate R1 with the following equation:

$$R1 = R2 \times \left(\frac{V_{AVDD}}{V_{FB2}} - 1 \right)$$

where V_{FB2} , the step-up regulator's feedback set point, is 2.0V. Place R1 and R2 close to the IC.

Loop Compensation

Choose R_{COMP} (R3 in Figure 1) to set the high-frequency integrator gain for fast-transient response. Choose C_{COMP} (C13 in Figure 1) to set the integrator zero to maintain loop stability.

For low-ESR output capacitors, use the following equations to obtain stable performance and good transient response:

$$R_{COMP} \approx \frac{250 \times V_{IN} \times V_{AVDD} \times C_{AVDD}}{L_{AVDD} \times I_{AVDD(MAX)}}$$

$$C_{COMP} \approx \frac{V_{AVDD} \times C_{AVDD}}{20 \times I_{AVDD(MAX)} \times R_{COMP}}$$

To further optimize transient response, vary R_{COMP} in 20% steps and C_{COMP} in 50% steps while observing transient response waveforms.

Charge-Pump Regulators

Selecting the Number of Charge-Pump Stages

For highest efficiency, always choose the lowest number of charge-pump stages that meet the output requirement.

The number of positive charge-pump stages is given by:

$$n_{POS} = \frac{V_{GON} - V_{SUPP}}{V_{SUPP} - (2 \times V_D) - (I_{GON} \times R_{EFF})}$$

where n_{POS} is the number of positive charge-pump stages, V_{GON} is the output of the positive charge-pump regulator, I_{GON} is the positive charge-pump output current, V_{SUPP} is the supply voltage of the charge-pump regulators, V_D is the forward voltage drop of the charge-pump diode, and R_{EFF} is the effective output resistance of the charge-pump switches (10 Ω typ.)

The number of negative charge-pump stages is given by:

$$n_{NEG} = \frac{-V_{GOFF}}{V_{SUPP} - (2 \times V_D) - (I_{GOFF} \times R_{EFF})}$$

where n_{NEG} is the number of negative charge-pump stages, V_{GOFF} is the output of the negative charge-pump regulator, and I_{GOFF} is the negative charge-pump output current.

The above equations assume that the flying capacitors are large enough to not further limit the output current.

Flying Capacitors

Increasing the flying capacitor (C_X) value lowers the effective source impedance and increases the output current capability. Increasing the capacitance indefinitely has a negligible effect on output current capability because the internal switch resistance and the diode impedance place a lower limit on the source impedance. A 0.1 μ F ceramic capacitor works well, except in cases of low frequency, low headroom, and high current. The flying capacitor's voltage rating must exceed the following:

$$V_{CX} > n \times V_{SUPP}$$

where n is the stage number in which the flying capacitor appears.

Low-Cost, Multiple-Output Power Supply for LCD Monitors/TVs

Charge-Pump Output Capacitor

Decreasing the flying capacitance reduces the output ripple. Increasing the output capacitance reduces the output ripple and improves the transient response. Use the following equations to approximate the output ripple:

$$V_{\text{RIPPLE_POS}} = \left[\frac{(\eta_{\text{POS}} + 1) \times V_{\text{SUPP}} - 2 \times \eta_{\text{POS}} \times V_{\text{D}} - V_{\text{OUT_POS}}}{\eta_{\text{POS}}} \right] \times \frac{C_{\text{X_POS}}}{C_{\text{OUT_POS}}}$$

$$V_{\text{RIPPLE_NEG}} = \left[\frac{\eta_{\text{NEG}} \times V_{\text{SUPP}} - 2 \times \eta_{\text{NEG}} \times V_{\text{D}} + V_{\text{OUT_NEG}}}{\eta_{\text{NEG}}} \right] \times \frac{C_{\text{X_NEG}}}{C_{\text{OUT_NEG}}}$$

where $V_{\text{OUT_POS}}$ is the positive charge-pump output voltage, $C_{\text{X_POS}}$ is the flying capacitor of the positive charge pump, $C_{\text{OUT_POS}}$ is the output capacitor of the positive charge-pump, $V_{\text{OUT_NEG}}$ is the negative charge-pump output voltage, $C_{\text{X_NEG}}$ is the flying capacitor of the negative charge pump, and $C_{\text{OUT_NEG}}$ is the output capacitor of the negative charge pump.

Output-Voltage Selection

Adjust the positive charge-pump regulator's output voltage by connecting a resistive voltage-divider from SRC to GND with the center tap connected to FBP (Figure 1). Select the lower resistor of divider R7 in the 10k Ω to 30k Ω range. Calculate upper resistor R8 with the following equation:

$$R7 = R8 \times \left(\frac{V_{\text{GON}}}{V_{\text{FBP}}} - 1 \right)$$

where $V_{\text{FBP}} = 2\text{V}$ (typ). Adding a small capacitor (e.g., 10pF) across R7 reduces pulse grouping and output noise.

Adjust the negative charge-pump regulator's output voltage by connecting a resistive voltage-divider from V_{GOFF} to REF with the center tap connected to FBN (Figure 1). Select R9 in the 35k Ω to 68k Ω range. Calculate R10 with the following equation:

$$R10 = R9 \times \frac{V_{\text{FBN}} - V_{\text{GOFF}}}{V_{\text{REF}} - V_{\text{FBN}}}$$

where $V_{\text{FBN}} = 250\text{mV}$, $V_{\text{REF}} = 12\text{V}$. Note that REF can only source up to 50 μA ; using a resistor less than 35k Ω for R9 results in higher bias current than REF can supply.

PC Board Layout and Grounding

Careful PC board layout is important for proper operation. Use the following guidelines for good PC board layout:

- 1) Minimize the area of respective high-current loops by placing each DC-DC converter's inductor, diode, and output capacitors near its input capacitors and its LX_ and GND_ pins. For the step-down regulator, the high-current input loop goes from the positive terminal of the input capacitor to the IC's IN pin, out of LX1, to the inductor, to the positive terminals of the output capacitors, reconnecting the output capacitor and input capacitor ground terminals. The high-current output loop is from the inductor to the positive terminals of the output capacitors, to the negative terminals of the output capacitors, and to the Schottky diode (D2). For the step-up regulator, the high-current input loop goes from the positive terminal of the input capacitor to the inductor, to the IC's LX2 pin, out of GND2, and to the input capacitor's negative terminal. The high-current output loop is from the positive terminal of the input capacitor to the inductor, to the output diode (D1), to the positive terminal of the output capacitors, reconnecting between the output capacitor and input capacitor ground terminals. Connect these loop components with short, wide connections. Avoid using vias in the high-current paths. If vias are unavoidable, use many vias in parallel to reduce resistance and inductance.
- 2) Create a power ground island (GND1) for the step-down regulator, consisting of the input and output capacitor grounds and the GND1 pin. Connect all these together with short, wide traces or a small ground plane. Similarly, create a power ground island (GND2) for the step-up regulator, consisting of the input and output capacitor grounds and the GND2 pin. Maximizing the width of the power ground traces improves efficiency and reduces output voltage ripple and noise spikes. Create an analog ground plane (GND) consisting of the GND pin, all the feedback-divider ground connections, the COMP and DEL capacitor ground connections, and the device's exposed backside pad, with a large area of in-the-layer or solder-side copper with large or multiple vias to the backside pad to cool the IC. Connect the GND1, GND2, and GND islands by connecting the three ground pins directly to the exposed backside pad. Make no other connections between these separate ground planes.

Low-Cost, Multiple-Output Power Supply for LCD Monitors/TVs

MAX8728

- 3) Place all feedback voltage-divider resistors as close to their respective feedback pins as possible. The divider's center trace should be kept short. Placing the resistors far away causes their FB traces to become antennas that can pick up switching noise. Care should be taken to avoid running any feedback trace near LX1, LX2, DRVP, or DRVN.
- 4) Place the INL pin and REF pin bypass capacitors as close to the device as possible. The ground connection of the INL bypass capacitor should be connected directly to the GND pin with a wide trace.
- 5) Minimize the length and maximize the width of the traces between the output capacitors and the load for best transient responses.
- 6) Minimize the size of the LX1 and LX2 nodes while keeping them wide and short. Keep the LX1 and LX2 nodes away from feedback nodes (FB1, FB2, FBP, and FBN) and analog ground. Use DC traces as shield if necessary.

Refer to the MAX8728 evaluation kit for an example of proper board layout.

Chip Information

TRANSISTOR COUNT: 6752

PROCESS: BiCMOS

Low-Cost, Multiple-Output Power Supply for LCD Monitors/TVs

Package Information

(The package drawing(s) in this data sheet may not reflect the most current specifications. For the latest package outline information, go to www.maxim-ic.com/packages.)

QFN THIN:EPS

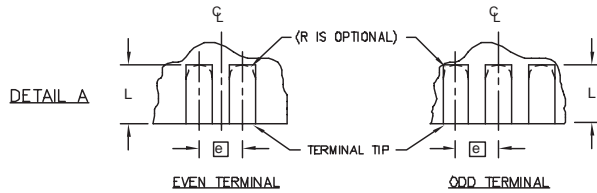
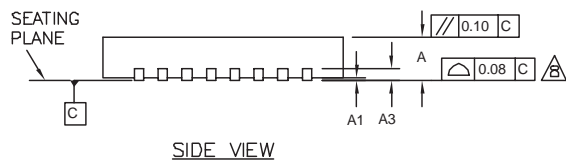
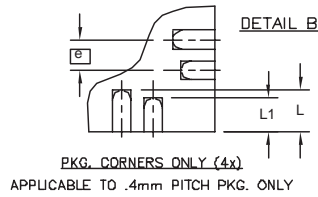
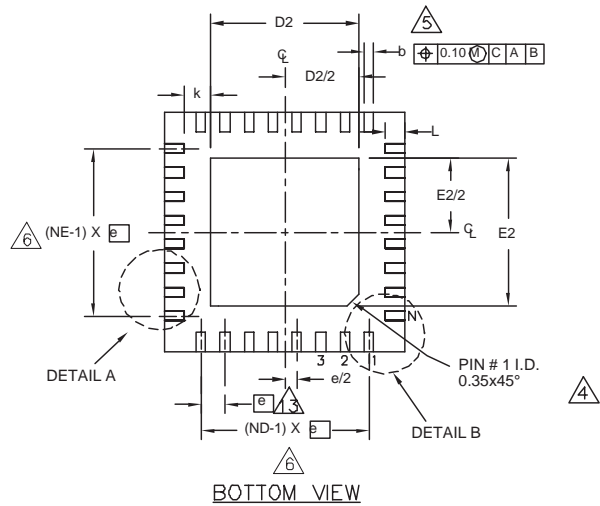
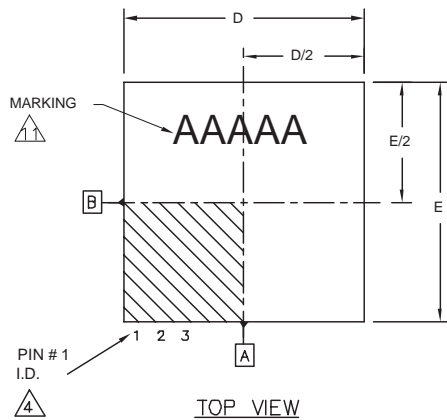

TITLE: PACKAGE OUTLINE, 16, 20, 28, 32, 40L THIN QFN, 5x5x0.8mm			
APPROVAL	DOCUMENT CONTROL NO.	REV.	1/2
	21-0140	I	

-DRAWING NOT TO SCALE-

Low-Cost, Multiple-Output Power Supply for LCD Monitors/TVs

Package Information (continued)

(The package drawing(s) in this data sheet may not reflect the most current specifications. For the latest package outline information, go to www.maxim-ic.com/packages.)

COMMON DIMENSIONS															
PKG.	16L 5x5			20L 5x5			28L 5x5			32L 5x5			40L 5x5		
SYMBOL	MIN.	NOM.	MAX.	MIN.	NOM.	MAX.	MIN.	NOM.	MAX.	MIN.	NOM.	MAX.	MIN.	NOM.	MAX.
A	0.70	0.75	0.80	0.70	0.75	0.80	0.70	0.75	0.80	0.70	0.75	0.80	0.70	0.75	0.80
A1	0	0.02	0.05	0	0.02	0.05	0	0.02	0.05	0	0.02	0.05	0	0.02	0.05
A3	0.20 REF.			0.20 REF.			0.20 REF.			0.20 REF.			0.20 REF.		
b	0.25	0.30	0.35	0.25	0.30	0.35	0.20	0.25	0.30	0.20	0.25	0.30	0.15	0.20	0.25
D	4.90	5.00	5.10	4.90	5.00	5.10	4.90	5.00	5.10	4.90	5.00	5.10	4.90	5.00	5.10
E	4.90	5.00	5.10	4.90	5.00	5.10	4.90	5.00	5.10	4.90	5.00	5.10	4.90	5.00	5.10
e	0.80 BSC.			0.65 BSC.			0.50 BSC.			0.50 BSC.			0.40 BSC.		
k	0.25	-	-	0.25	-	-	0.25	-	-	0.25	-	-	0.25	0.35	0.45
L	0.30	0.40	0.50	0.45	0.55	0.65	0.45	0.55	0.65	0.30	0.40	0.50	0.40	0.50	0.60
L1	-	-	-	-	-	-	-	-	-	-	-	-	0.30	0.40	0.50
N	16			20			28			32			40		
ND	4			5			7			8			10		
NE	4			5			7			8			10		
JEDEC	WHHB			WHHC			WHHD-1			WHHD-2			-----		

EXPOSED PAD VARIATIONS									
PKG. CODES	D2			E2			L <small>exposed</small> ±0.15	DOWN BONDS ALLOWED	
	MIN.	NOM.	MAX.	MIN.	NOM.	MAX.			
T1655-2	3.00	3.10	3.20	3.00	3.10	3.20	**	YES	
T1655-3	3.00	3.10	3.20	3.00	3.10	3.20	**	NO	
T1655N-1	3.00	3.10	3.20	3.00	3.10	3.20	**	NO	
T2055-3	3.00	3.10	3.20	3.00	3.10	3.20	**	YES	
T2055-4	3.00	3.10	3.20	3.00	3.10	3.20	**	NO	
T2055-5	3.15	3.25	3.35	3.15	3.25	3.35	0.40	YES	
T2855-3	3.15	3.25	3.35	3.15	3.25	3.35	**	YES	
T2855-4	2.60	2.70	2.80	2.60	2.70	2.80	**	YES	
T2855-5	2.60	2.70	2.80	2.60	2.70	2.80	**	NO	
T2855-6	3.15	3.25	3.35	3.15	3.25	3.35	**	NO	
T2855-7	2.60	2.70	2.80	2.60	2.70	2.80	**	YES	
T2855-8	3.15	3.25	3.35	3.15	3.25	3.35	0.40	YES	
T2855N-1	3.15	3.25	3.35	3.15	3.25	3.35	**	NO	
T3255-3	3.00	3.10	3.20	3.00	3.10	3.20	**	YES	
T3255-4	3.00	3.10	3.20	3.00	3.10	3.20	**	NO	
T3255-5	3.00	3.10	3.20	3.00	3.10	3.20	**	YES	
T3255N-1	3.00	3.10	3.20	3.00	3.10	3.20	**	NO	
T4055-1	3.20	3.30	3.40	3.20	3.30	3.40	**	YES	

**SEE COMMON DIMENSIONS TABLE

NOTES:

- DIMENSIONING & TOLERANCING CONFORM TO ASME Y14.5M-1994.
- ALL DIMENSIONS ARE IN MILLIMETERS. ANGLES ARE IN DEGREES.
- N IS THE TOTAL NUMBER OF TERMINALS.
- THE TERMINAL #1 IDENTIFIER AND TERMINAL NUMBERING CONVENTION SHALL CONFORM TO JESD 95-1 SPP-012. DETAILS OF TERMINAL #1 IDENTIFIER ARE OPTIONAL, BUT MUST BE LOCATED WITHIN THE ZONE INDICATED. THE TERMINAL #1 IDENTIFIER MAY BE EITHER A MOLD OR MARKED FEATURE.
- DIMENSION b APPLIES TO METALLIZED TERMINAL AND IS MEASURED BETWEEN 0.25 mm AND 0.30 mm FROM TERMINAL TIP.
- ND AND NE REFER TO THE NUMBER OF TERMINALS ON EACH D AND E SIDE RESPECTIVELY.
- DEPOPULATION IS POSSIBLE IN A SYMMETRICAL FASHION.
- COPLANARITY APPLIES TO THE EXPOSED HEAT SINK SLUG AS WELL AS THE TERMINALS.
- DRAWING CONFORMS TO JEDEC MO220, EXCEPT EXPOSED PAD DIMENSION FOR T2855-3 AND T2855-6.
- WARPAGE SHALL NOT EXCEED 0.10 mm.
- MARKING IS FOR PACKAGE ORIENTATION REFERENCE ONLY.
- NUMBER OF LEADS SHOWN ARE FOR REFERENCE ONLY.
- LEAD CENTERLINES TO BE AT TRUE POSITION AS DEFINED BY BASIC DIMENSION "e", ±0.05.

-DRAWING NOT TO SCALE-

		
TITLE: PACKAGE OUTLINE, 16, 20, 28, 32, 40L THIN QFN, 5x5x0.8mm		
APPROVAL	DOCUMENT CONTROL NO.	REV.
	21-0140	I 2/2

Maxim cannot assume responsibility for use of any circuitry other than circuitry entirely embodied in a Maxim product. No circuit patent licenses are implied. Maxim reserves the right to change the circuitry and specifications without notice at any time.

Maxim Integrated Products, 120 San Gabriel Drive, Sunnyvale, CA 94086 408-737-7600 29