

PLEASE CHECK WWW.MOLEX.COM FOR LATEST PART INFORMATION

Part Number: [0190710283](#)
Status: **Active**
Description: InsulKrimp™ Ring Tongue Terminal for 2 AWG Wire

Documents:

[Drawing \(PDF\)](#) [RoHS Certificate of Compliance \(PDF\)](#)
[Product Specification PS-19902-009 \(PDF\)](#)

General

Product Family	Ring and Spade Terminals
Series	19071
Crimp Quality Equipment	Yes
Mil-Spec	N/A
Product Name	InsulKrimp™
Type	Ring

Physical

Barrel Type	Closed
Color - Resin	Natural
Insulation	PVC
Material - Plating Mating	Tin
Packaging Type	Bag
Stud Size	3/8" (M9)
Wire Insulation Diameter	16.50mm (.650") max.
Wire Size AWG	2

Material Info

Old Part Number	G-675-38X
-----------------	-----------

Reference - Drawing Numbers

Product Specification	PS-19902-009
Sales Drawing	SD-19071-005

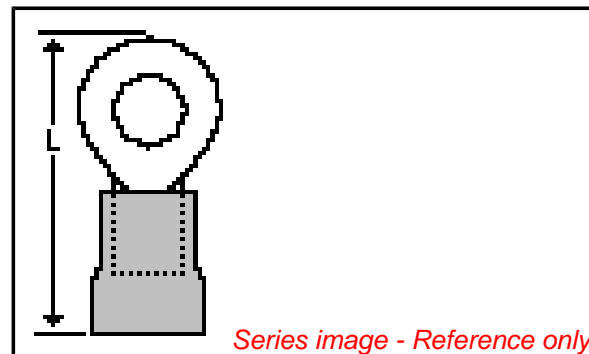

EU RoHS

**ELV and RoHS
Compliant**
REACH SVHC
 Not Reviewed
**Halogen-Free
Status**
Not Reviewed

China RoHS



**Need more information on product
environmental compliance?**

Email productcompliance@molex.com
 For a multiple part number RoHS Certificate of
 Compliance, [click here](#)

Please visit the [Contact Us](#) section for any
 non-product compliance questions.

Search Parts in this Series

[19071Series](#)

Application Tooling | [FAQ](#)

*Tooling specifications and manuals are
 found by selecting the products below.
 Crimp Height Specifications are then
 contained in the Application Tooling
 Specification document.*

Global

Description	Product #
Manual Putt Pump Hydraulic System, Die set required	0192860117
Die Set (large) for the HHLS Hydraulic Crimper	0192890010
Hand Crimp Tool	0640013900
Putt Pump Dieless Head System	0192860065

MATERIAL: Copper
 PLATING: Electro-Tin (.0003 Min.)
 INSULATION: PVC COLOR CODED RED
 STUD SIZES: ("D" ±.005)

INSULKRIMP X

*Optional Style

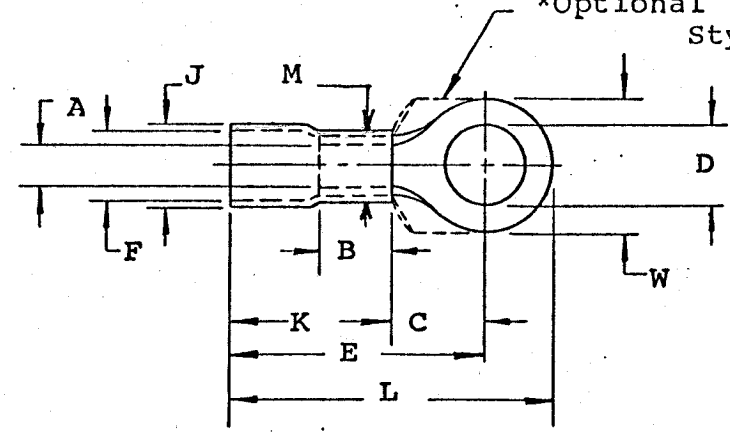

"M" = .630" Maximum

- 10 - .198
- 14 - .265
- 56 - .328
- 38 - .390
- 76 - .453
- 12 - .515
- 58 - .656
- 34 - .781

Part Number	"W"	"C" Min.	"E" Max.	"K" Max.	"L" Max.	"A" Min. Avg.	"F" (MWID)	Stock Thickness	"J" Max.	"B" Min.	Available Stud Size
G-674-X	.893 .867	.693	1.803	1.065	2.234	.355	.650	.075	.760	.490	14, 56, 38, 76 12, 58
G-675-X	.643 .617	.693	1.803	1.065	2.110	.355	.650	.075	.760	.490	10, 14, 56, 38 76
G-676-X	.893 .867	.990	2.090	1.065	2.527	.355	.650	.075	.760	.490	14, 56, 38, 76 12, 58
G-677-X	1.268 1.242	.990	2.090	1.065	2.685	.355	.650	.075	.760	.490	14, 56, 38, 76 12, 58, 34

NOTE: (MWID) denotes maximum wire insulation diameter.



TITLE: CUSTOMER DRAWING
 #2 WIRE SIZE (G)
 RING TONGUE TERMINAL

DIMENSIONAL TOLERANCE UNLESS OTHERWISE SPECIFIED		
FRAC.	DEC.	ANG.
±	±	±

REVISION	SCALE: _____	DATE
	DRWN. BY: JTK	1-21-70
	CHKD. BY:	
	APPRD. BY:	
	DRAWING NO.:	