

Silicon NPN Power Transistors

2SC3083

DESCRIPTION

- With TO-3PN package
- High breakdown voltage (V_{CBO} 500V)
- Fast switching speed
- Wide ASO (Safe Operating Area)

APPLICATIONS

- 400V/6A switching regulator applications

PINNING

PIN	DESCRIPTION
1	Base
2	Collector;connected to mounting base
3	Emitter

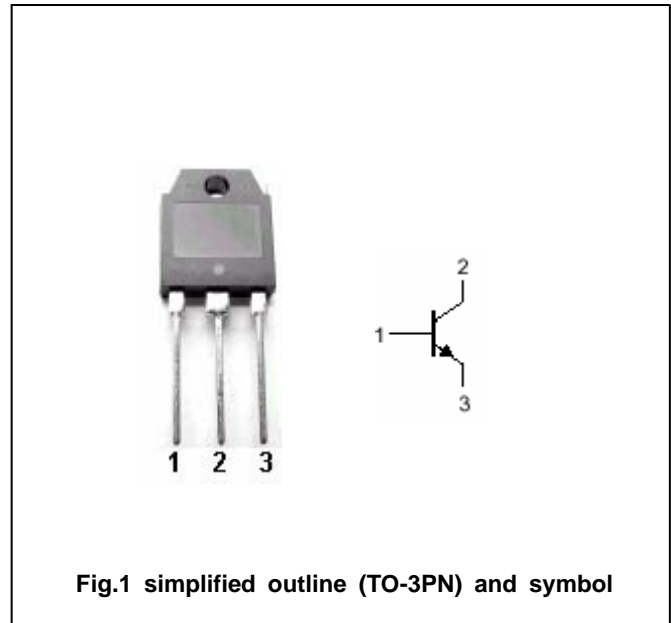

Fig.1 simplified outline (TO-3PN) and symbol

Absolute maximum ratings ($T_a=25$)

SYMBOL	PARAMETER	CONDITIONS	VALUE	UNIT
V_{CBO}	Collector-base voltage	Open emitter	500	V
V_{CEO}	Collector-emitter voltage	Open base	400	V
V_{EBO}	Emitter-base voltage	Open collector	7	V
I_C	Collector current		6	A
I_{CM}	Collector current-peak		12	A
I_B	Base current		2	A
P_C	Collector power dissipation	$T_a=25$	2.5	W
		$T_C=25$	60	
T_j	Junction temperature		150	
T_{stg}	Storage temperature		-55~150	

Silicon NPN Power Transistors

2SC3083

CHARACTERISTICS

T_j=25 unless otherwise specified

SYMBOL	PARAMETER	CONDITIONS	MIN	TYP.	MAX	UNIT
V _{(BR)CEO}	Collector-emitter breakdown voltage	I _C =5mA ; R _{BE} =	400			V
V _{(BR)CBO}	Collector-base breakdown voltage	I _C =1mA ; I _E =0	500			V
V _{(BR)EBO}	Emitter-base breakdown voltage	I _E =1mA ; I _C =0	7			V
V _{CEsat}	Collector-emitter saturation voltage	I _C =2A ; I _B =0.4A			1.0	V
V _{BEsat}	Base-emitter saturation voltage	I _C =2A ; I _B =0.4A			1.5	V
I _{CBO}	Collector cut-off current	V _{CB} =400V ; I _E =0			10	μA
I _{EBO}	Emitter cut-off current	V _{EB} =5V ; I _C =0			10	μA
h _{FE-1}	DC current gain	I _C =0.4A ; V _{CE} =5V	15		50	
h _{FE-2}	DC current gain	I _C =2A ; V _{CE} =5V	8			
C _{OB}	Output capacitance	I _E =0 ; V _{CB} =10V ; f=1MHz		40		pF
f _T	Transition frequency	I _C =0.4A ; V _{CE} =10V		20		MHz

Switching times

t _{on}	Turn-on time	I _C =3A ; I _{B1} =-I _{B2} =0.6A R _L =66.6 Ω , V _{CC} =200V			1.0	μs
t _s	Storage time				2.5	μs
t _f	Fall time				1.0	μs

◆ h_{FE-1} classifications

L	M	N
15-30	20-40	30-50

Silicon NPN Power Transistors

2SC3083

PACKAGE OUTLINE

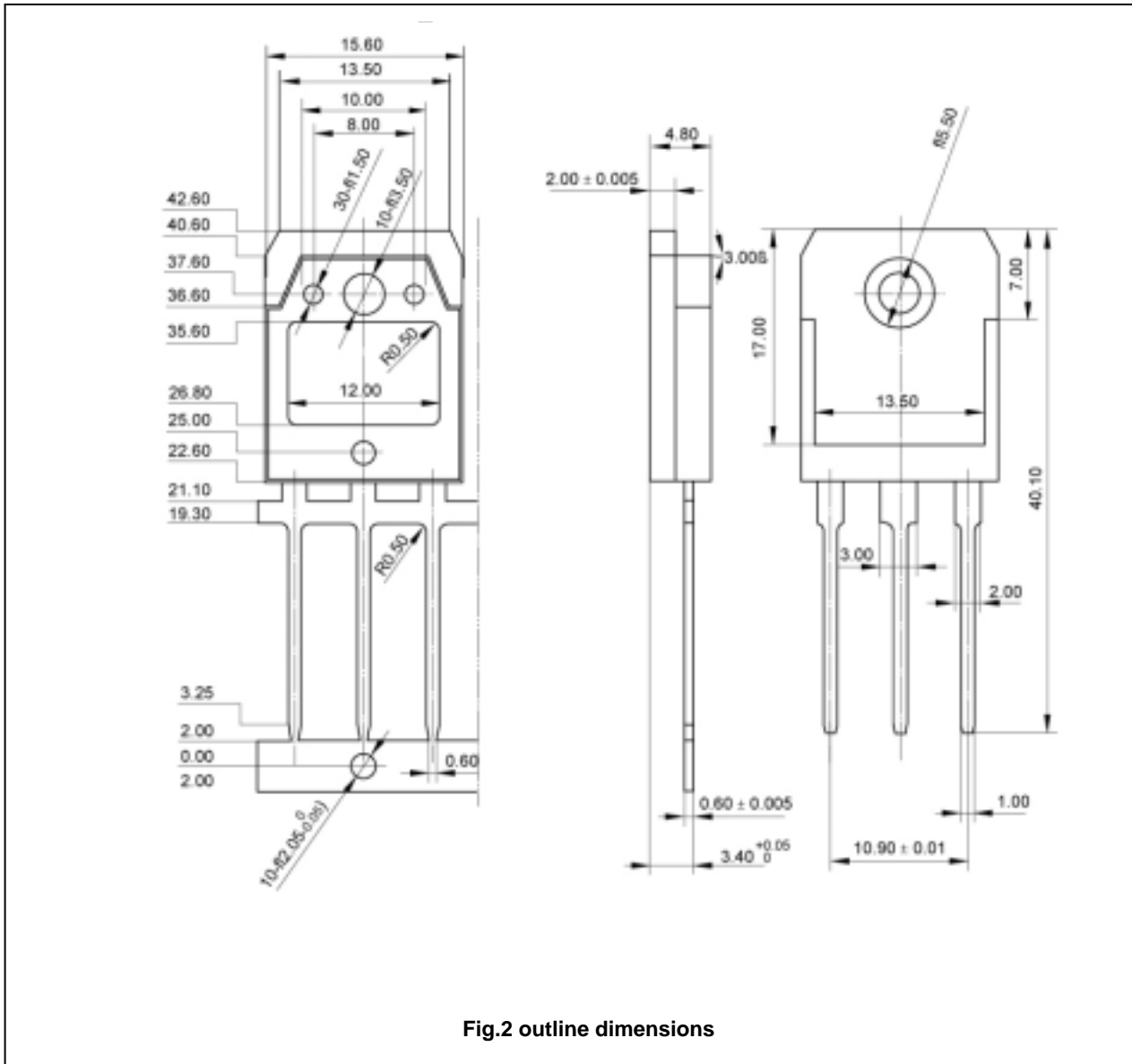

Fig.2 outline dimensions

Silicon NPN Power Transistors

2SC3083

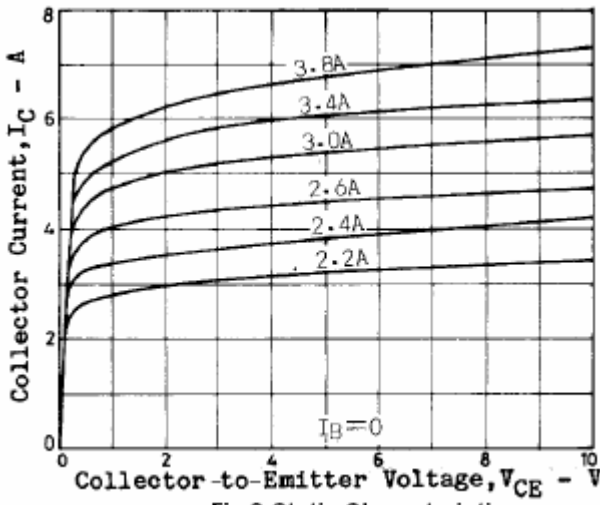

Fig.3 Static Characteristic

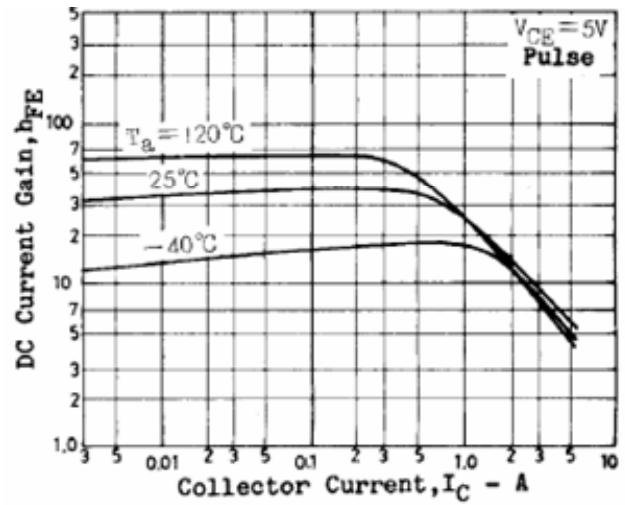

Fig.4 DC current Gain

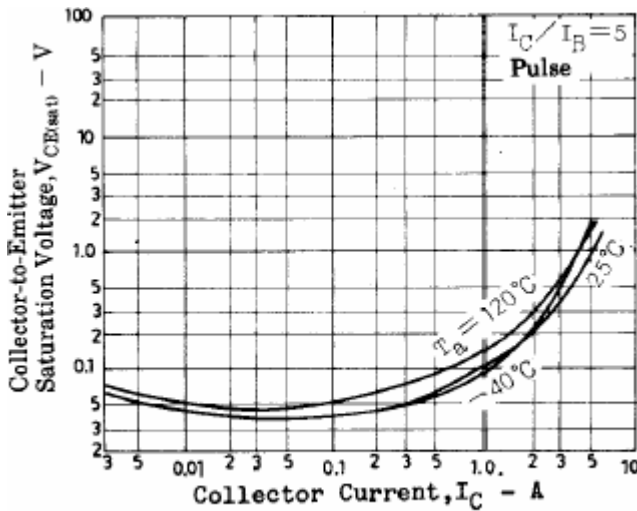

Fig.5 Collector-Emmitter Saturation Voltage

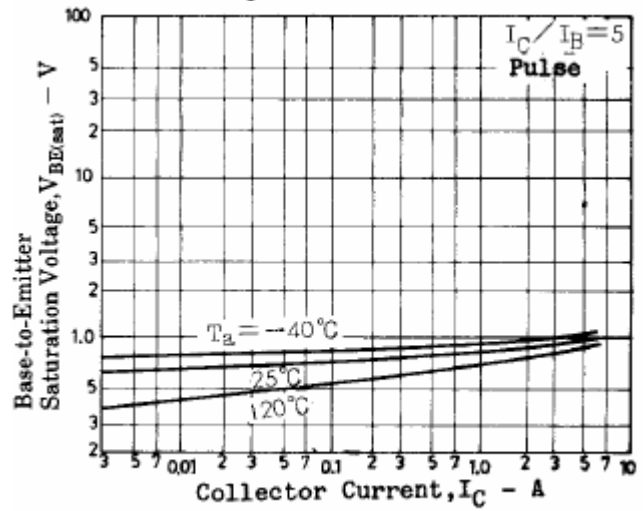

Fig.6 Base-Emmitter Saturation Voltage

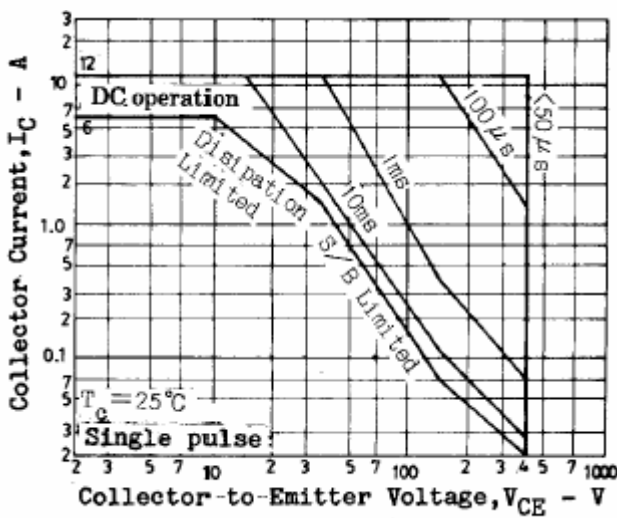

Fig.7 Safe Operating Area