

## Features

- Low Series Resistance
- Low Capacitance
- High Cutoff Frequency
- Silicon Nitride Passivation
- Polyimide Scratch Protection
- Designed for Easy Circuit Insertion

## Description and Applications

M/A-COM's MA4E1317 single, MA4E1318 anti-parallel pair, MA4E1319-1 reverse tee, MA4E1319-2 series tee and MA4E2160 unconnected anti-parallel pair are gallium arsenide flip chip Schottky barrier diodes. These devices are fabricated on OMCVD epitaxial wafers using a process designed for high device uniformity and extremely low parasitics. The diodes are fully passivated with silicon nitride and have an additional layer of polyimide for scratch protection. The protective coatings prevent damage to the junction during automated or manual handling. The flip chip configuration is suitable for pick and place insertion. The high cutoff frequency of these diodes allows use through millimeter wave frequencies. Typical applications include single and double balanced mixers in PCN transceivers and radios, police radar detectors, and automotive radar detectors. The devices can be used through 80 GHz.

The MA4E1318 anti-parallel pair is designed for use in sub harmonically pumped mixers. Close matching of the diode characteristics results in high LO suppression at the RF input.

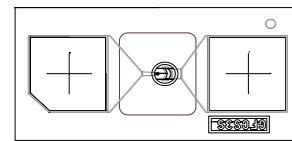

MA4E1317

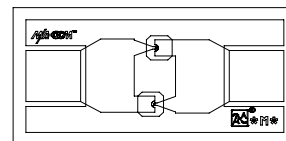

MA4E1318

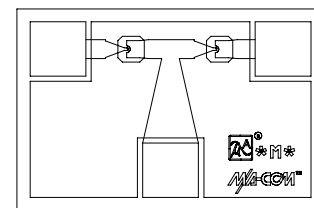

MA4E1319-1

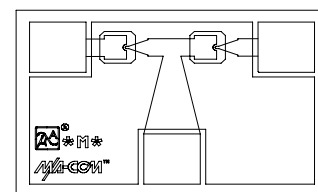

MA4E1319-2

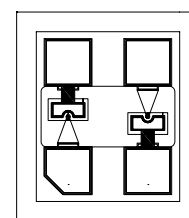

MA4E2160

**Electrical Specifications @ + 25 °C**

Parameters and Test Conditions	Symbol	Units	MA4E1317			MA4E1318		
			Min.	Typ.	Max.	Min.	Typ.	Max.
Junction Capacitance at 0V at 1 MHz	Cj	pF		.020			.020 <sup>3</sup>	
Total Capacitance at 0V at 1 MHz <sup>1</sup>	Ct	pF	.030	.045	.060	.030 <sup>3</sup>	.045 <sup>3</sup>	.060 <sup>3</sup>
Junction Capacitance Difference	DCj	pF					.005	.010
Series Resistance at +10mA <sup>2</sup>	Rs	Ohms		4	7		4	7
Forward Voltage at +1mA	Vf1	Volts	.60	.70	.80	.60	.70	.80
Forward Voltage Difference at 1mA	DVf	Volts					.005	.010
Reverse Breakdown Voltage at -10uA	Vbr	Volts	4.5	7				
SSB Noise Figure	NF	dB		6.5 <sup>4</sup>			6.5 <sup>4</sup>	

Parameters and Test Conditions	Symbol	Units	MA4E1319-1 or -2			MA4E2160		
			Min.	Typ.	Max.	Min.	Typ.	Max.
Junction Capacitance at 0V at 1 MHz	Cj	pF		.020 <sup>3</sup>			.020 <sup>3</sup>	
Total Capacitance at 0V at 1 MHz <sup>1</sup>	Ct	pF	.030 <sup>3</sup>	.045 <sup>3</sup>	.060 <sup>3</sup>	.030 <sup>3</sup>	.045 <sup>3</sup>	.060 <sup>3</sup>
Junction Capacitance Difference	DCj	pF		.005	.010		.005	.010
Series Resistance at +10mA <sup>2</sup>	Rs	Ohms		4	7		4	7
Forward Voltage at +1mA	Vf1	Volts	.60	.70	.80	.60	.70	.80
Forward Voltage Difference at 1mA	DVf	Volts		.005	.010		.005	.010
Reverse Breakdown Voltage at -10uA	Vbr	Volts	4.5	7		4.5	7	
SSB Noise Figure	NF	dB		6.5 <sup>4</sup>			6.5 <sup>4</sup>	

**Notes:**

1. Total capacitance is equivalent to the sum of junction capacitance Cj and parasitic capacitance Cp.
2. Series resistance is determined by measuring the dynamic resistance and subtracting the junction resistance of 2.6 ohms.
3. Capacitance for the MA4E1318, MA4E2160, MA4E1319-1 or -2 is per Schottky diode.
4. Measured at an LO frequency of 9.375 GHz, with an IF frequency of 300 MHz. LO drive level is +6 dBm for a single Schottky junction. The IF noise figure contribution (1.5 dB) is included.

### Forward Current vs Temperature

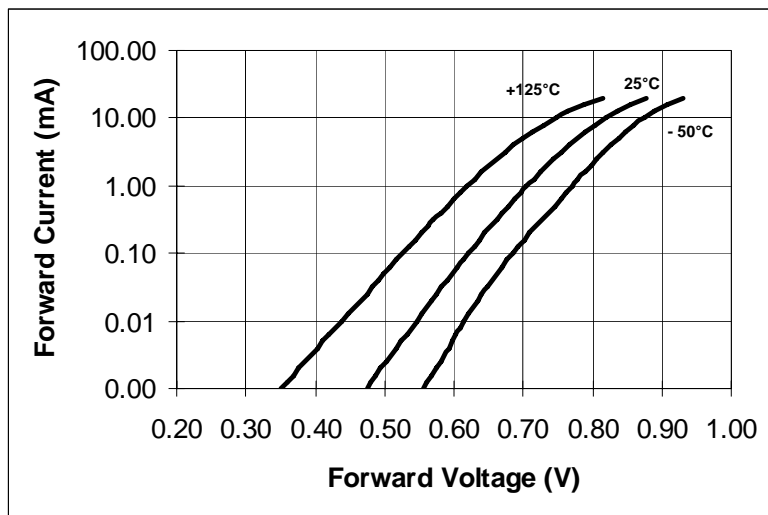

### Absolute Maximum Ratings <sup>1</sup>

Parameter	Absolute Maximum
Operating Temperature	-65 °C to +125 °C
Storage Temperature	-65 °C to +150 °C
Incident LO Power	+20 dBm
Incident RF Power	+20 dBm .
Mounting Temperature	+235°C for 10 seconds
Electrostatic Discharge ( ESD ) Classification <sup>2</sup>	Class 0

1. Operation of this device above any one of these parameters may cause permanent damage.
2. Human Body Model

### Mounting Techniques

These chips were designed to be inserted onto hard or soft substrates with the junction side down. They can be mounted with conductive epoxy or with a low temperature solder preform. The die can also be assembled with the junction side up, and wire or ribbon bonds made to the pads.

### Solder Die Attach:

Solder which does not scavenge gold, such as Indalloy # 2, is recommended. Sn-Pb based solders are not recommended due to solder embrittlement. Do not expose die to a temperature greater than 235°C, or greater than 200°C for longer than 10 seconds. No more than three seconds of scrubbing should be required for attachment.

### Epoxy Die Attach:

Assembly can be preheated to 125 - 150°C. Use a minimum amount of epoxy. Cure epoxy as per manufacturer's schedule. For extended cure times, temperatures should be kept below 200°C.

### Handling Procedures

The following precautions should be observed to avoid damaging these chips:

**Cleanliness:** The chips should be handled in a clean environment. Do not attempt to clean die after installation.

**Static Sensitivity:** Schottky barrier diodes are ESD sensitive and can be damaged by static electricity. Proper ESD techniques should be used when handling these devices.

**General Handling:** The protective polymer coating on the active areas of these die provides scratch protection, particularly for the metal air bridge which contacts the anode. Die can be handled with tweezers or vacuum pickups and are suitable for use with automatic pick-and-place equipment.

### GaAs Flip Chip Ordering Information

Part Number	Package	Standard Quantity per Carrier
MA4E1317	Die in Carrier	100
MADS-001317-1278HP	Pocket Tape on Reel	3000
MA4E1318	Wafer on Frame	100
MADS-001318-1197HP	Pocket Tape on Reel	3000
MA4E1319-1	Die in Carrier	100
MA4E1319-2	Die in Carrier	100
MA4E2160	Die in Carrier	100

Flip Chip Outline Drawings

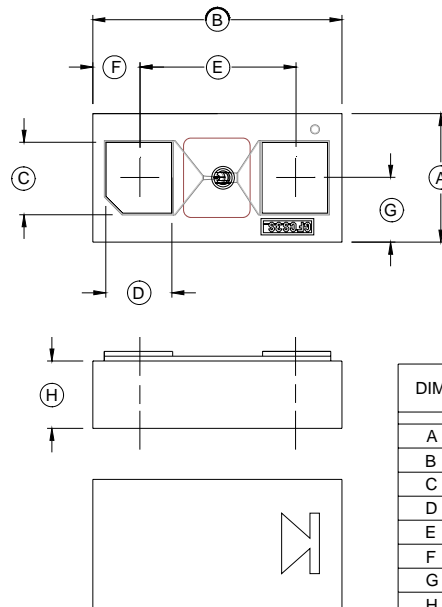

MA4E1317  
Case Style 1278

DIM.	INCHES		MILLIMETERS	
	MIN.	MAX.	MIN.	MAX.
A	0.013	0.014	0.330	0.335
B	0.026	0.027	0.660	0.685
C	0.008	0.009	0.203	0.228
D	0.007	0.008	0.177	0.203
E	0.016	0.017	0.406	0.430
F	0.004	0.006	0.101	0.152
G	0.006	0.007	0.152	0.177
H	0.0075	0.0085	0.190	0.216

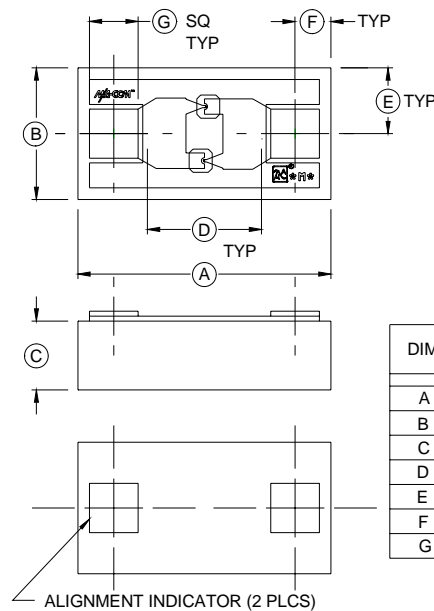

MA4E1318  
Case Style 1197

DIM.	INCHES		MILLIMETERS	
	MIN.	MAX.	MIN.	MAX.
A	.025	.027	.64	.69
B	.012	.015	.32	.37
C	.006	.008	.15	.20
D	.018	.020	.45	.50
E	.0075	.0085	.190	.216
F	.003	.005	.08	.13
G	.004	.006	.10	.15

Flip Chip Outline Drawings

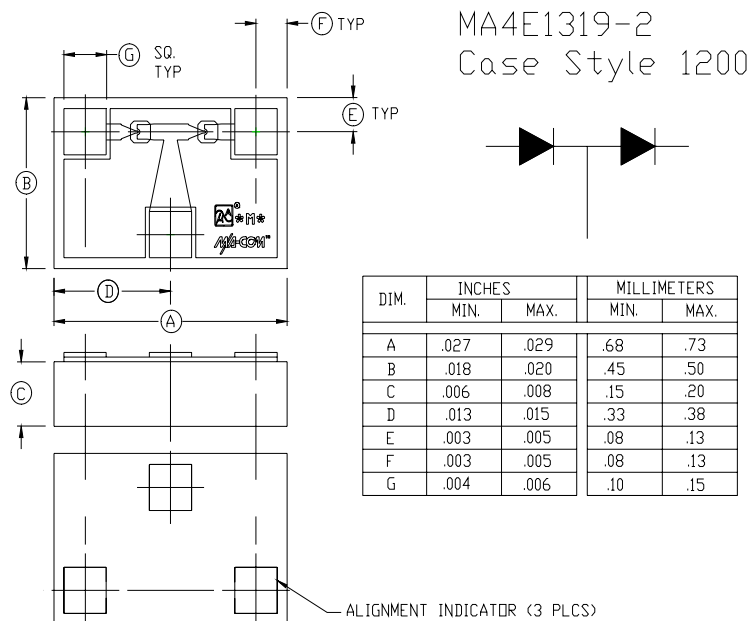
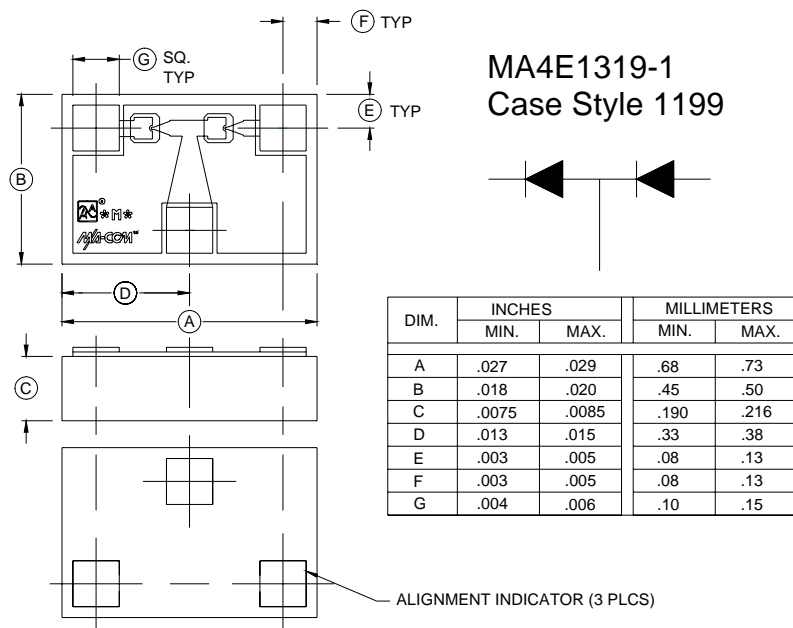

# MA4E1317, MA4E1318, MA4E1319-1, MA4E1319-2, MA4E2160



## GaAs Flip Chip Schottky Barrier Diodes

M/A-COM Products  
Rev. V7

### Flip Chip Outline Drawings

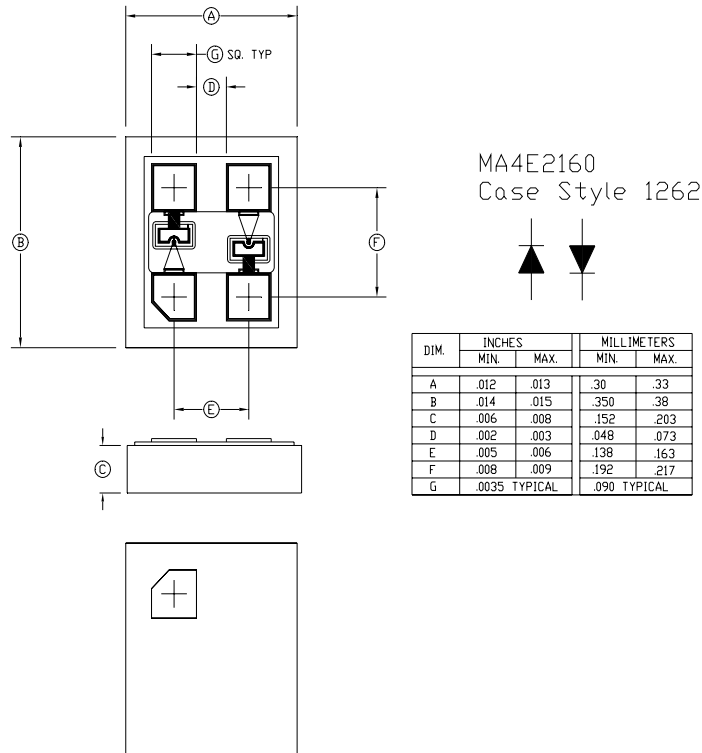

**ADVANCED:** Data Sheets contain information regarding a product M/A-COM Technology Solutions is considering for development. Performance is based on target specifications, simulated results, and/or prototype measurements. Commitment to develop is not guaranteed.  
**PRELIMINARY:** Data Sheets contain information regarding a product M/A-COM Technology Solutions has under development. Performance is based on engineering tests. Specifications are typical. Mechanical outline has been fixed. Engineering samples and/or test data may be available. Commitment to produce in volume is not guaranteed.

• **North America** Tel: 800.366.2266 • **Europe** Tel: +353.21.244.6400  
 • **India** Tel: +91.80.43537383 • **China** Tel: +86.21.2407.1588  
 Visit [www.macomtech.com](http://www.macomtech.com) for additional data sheets and product information.

M/A-COM Technology Solutions Inc. and its affiliates reserve the right to make changes to the product(s) or information contained herein without notice.