



PRODUCT SPECIFICATION

Model No : CSLR-N55FWW4-A0

Descriptions:	
■ LED Type	: Lighting LED Lamp
■ LED Package	: Round LED Lamp
■ Emitting Color	: Warm White
■ Viewing Angle	: 110°
■ No Stopper	



CUSTOMER APPROVED SIGNATURES	APPROVED BY	CHECKED BY	PREPARED BY

CHINA SEMICONDUCTOR CORPORATION
Address: 2FL. NO.909, Chung-Cheng Road,
Chung-Ho City Taipei Hsien, Taiwan.

OPTO PLUS TECHNOLOGIES CO.,LTD
Address: 696 Shun jiang Rd., Ji Shan St. Shaoxing,
ZheJiang, China

Tel: 886-2-2223-9696
Fax: 886-2-2223-9377

Tel: 86-0575-88623888
Fax: 86-0575-88623112



Model No : CSLR-N55FWW4-A0

Features -

1. Low Power Consumption.
2. High Luminous Output
3. High Reliability and Solid Performance
4. Optimal Optical/Mechanical Design
5. Rohs Compliant

Device Selection Guide -

Part No.	Chip		LED Lens
	Material	Emitted Color	
CSLR-N55FWW4-A0	InGaN	White	Water Transparent

Package Outline Dimensions -

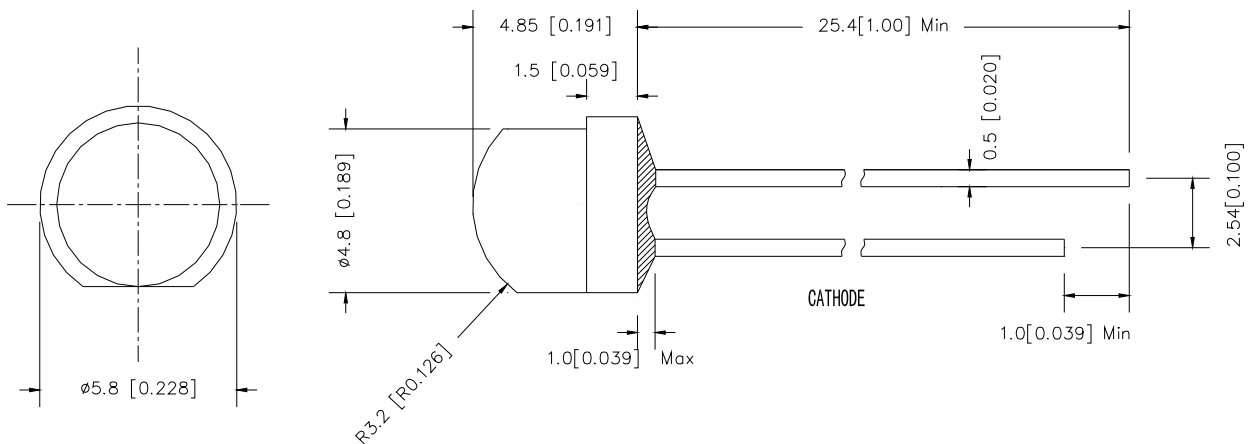

* Tolerance : $\pm \frac{0.01}{0.25}$ Unit : $\pm \frac{\text{inch}}{\text{mm}}$



Model No : CSLR-N55FWW4-A0

■ Absolute Maximum Rating -

(Ta=25°C)

Parameter	Symbol	Rating	Unit
Power Dissipation	Pd	76	mW
Forward Current (DC)	IF	30	mA
Peak Forward Current *	IFP	100	mA
Reverse Voltage	VR	5	V
Operating Temp.	Topr	-30 ~ +80	°C
Storage Temp.	Tstg	-40 ~ +100	°C
Lead Soldering Temperature	Tsol	Max. 260°C for 5 sec Max. (3mm from the epoxy body)	

* Pulse width ≤ 0.1 msec. duty $\leq 1/10$

■ Electro-optical Characteristics

(Ta=25°C)

Parameter	Symbol	Min.	Typ.	Max.	Unit	Condition
Forward Voltage	VF	-----	3.2	3.8	V	IF=20mA
Luminous Intensity	Iv	830	1500	-----	mcd	
Chromaticity	X	-----	0.45	-----		
Coordination	Y	-----	0.41	-----		
Viewing Angle	2θ 1/2	-----	110	-----	deg	
Reverse Current	IR	-----	-----	50	μA	VR=5V



Spec. No.	PS-LL-N55FWW4-A0
Rev.	A

■ Luminous Intensity Rank Limits (IF = 20mA)

unit : mcd

Part No. Code	CSLR-N55FWW4-A0	
	min.	max.
M	830	1080
N	1080	1400
P	1400	1800
Q	1800	2300
R	2300	3000

■ Forward Voltage Rank Limits(IF=20mA)

unit : V

Part No. Code	CSLR-N55FWW4-A0	
	min.	max.
H	2.8	3.0
J	3.0	3.2
K	3.2	3.4
L	3.4	3.6
M	3.6	3.8

■ Color Rank Limits (IF = 20mA)

L1					L5				
X	0.4314	0.4390	0.4680	0.4601	X	0.4601	0.4680	0.4970	0.4863
Y	0.4135	0.4310	0.4385	0.4238	Y	0.4238	0.4385	0.4466	0.4290
L2					L6				
X	0.4267	0.4314	0.4601	0.4519	X	0.4519	0.4601	0.4863	0.4770
Y	0.3986	0.4135	0.4238	0.4086	Y	0.4086	0.4238	0.4290	0.4137
L3					L7				
X	0.4222	0.4267	0.4519	0.4434	X	0.4434	0.4519	0.4770	0.4683
Y	0.3853	0.3986	0.4086	0.3930	Y	0.3930	0.4086	0.4137	0.3995
L4					L8				
X	0.4186	0.4222	0.4434	0.4355	X	0.4355	0.4434	0.4683	0.4588
Y	0.3709	0.3853	0.3930	0.3785	Y	0.3785	0.3930	0.3995	0.3838

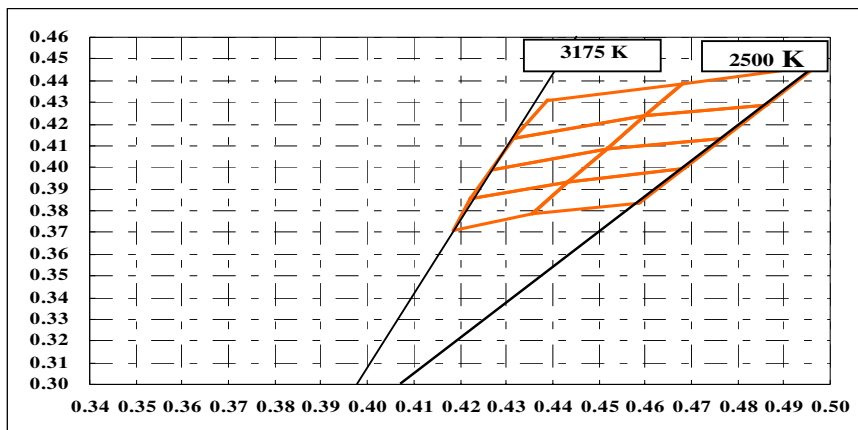

Notes:

1. Tolerance of measurement of luminous intensity :±15%
2. Tolerance of measurement of Color Coordinates :±0.01
3. Tolerance of measurement of forward voltage :±0.05V
4. All data are measured by CSC's test equipment.
5. One delivery will include several color rank, VF rank and Iv ranks of the products.
6. The quantity-ratio of the ranks is decided by CSC.
7. Please confirm with CSC salesman, if your request different from standard specification.



Spec. No.	PS-LL-N55FWW4-A0
Rev.	A

Model No : CSLR-N55FWW4-A0

■ Typical Electrical / Optical Characteristics Curves -

(Ta = 25°C Unless Otherwise Noted)

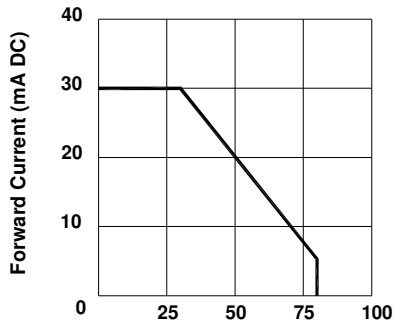

Ambient Temperature Ta (°C)
Fig 1. Forward Current
Vs. Ambient Temperature

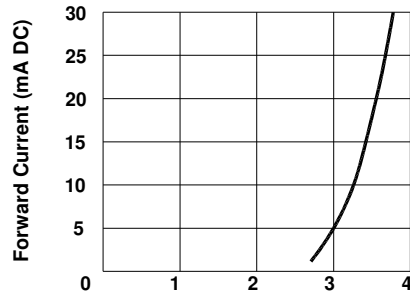

Forward Voltage VF (V)
Fig 2. Forward Current
Vs. Forward Voltage

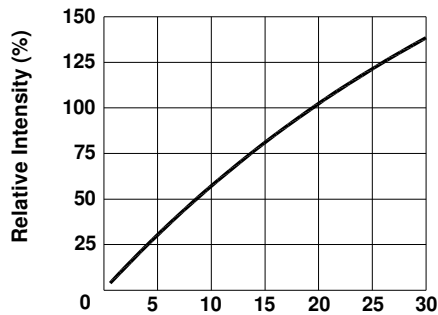

Forward Current IF (mA DC)
Fig 3. Relative Intensity
Vs. Forward Current

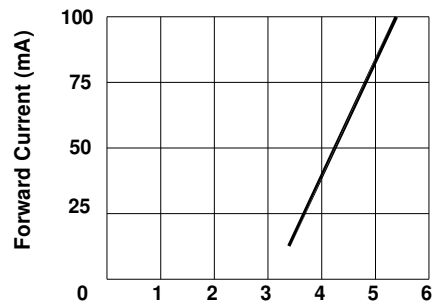

Forward Voltage (V)
Fig 4. Peak Forward Voltage
Vs. Forward Current
(100us test pulse, 1% duty cycle)

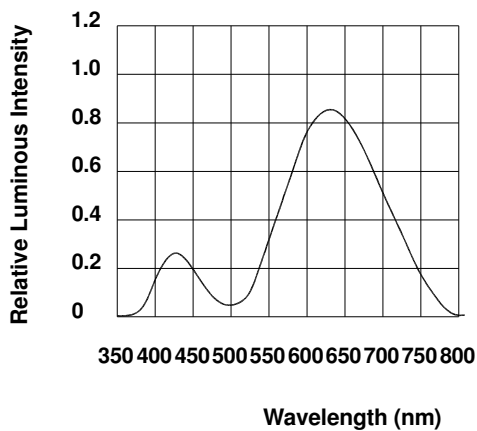

Fig 5. Relative Intensity Vs. Wavelength

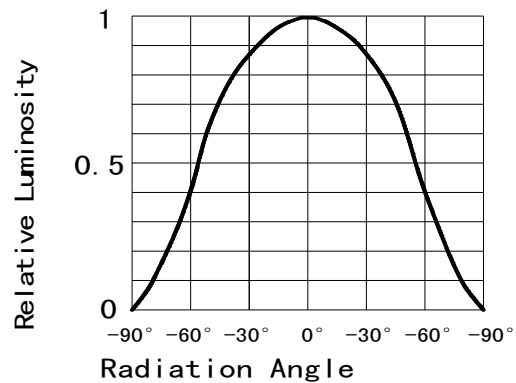

Fig 6. Relative Luminous Intensity vs. Radiation Angle



Model No : CSLR-N55FWW4-A0

■ Precautions For Use -

1. Recommended Soldering conditions

Wave Soldering

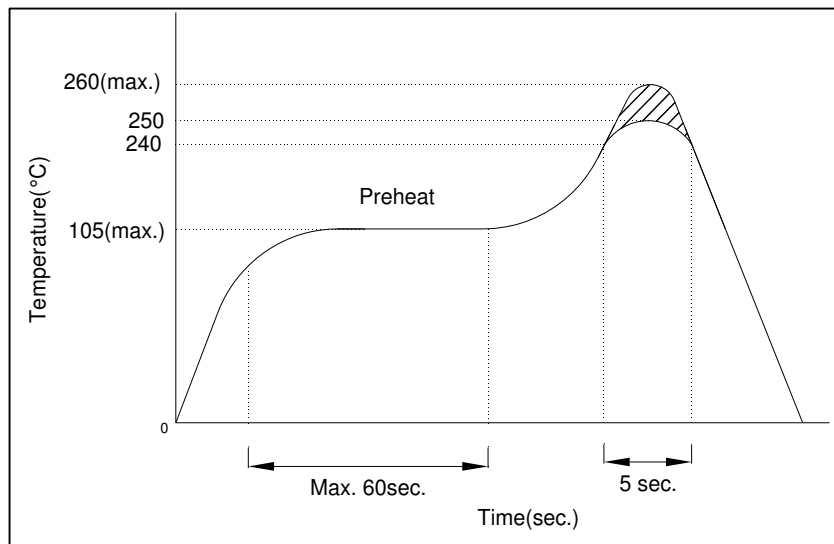

2. Soldering Iron

Basic SPEC. is ≤ 5 sec. When 260°C . If temperature is higher, time should be shorter ($+10^{\circ}\text{C} \rightarrow -1$ sec.). Power dissipation of iron should be smaller than 15W, and temperature should be controllable. Surface temperature of the device should be under 230°C .

3. Static Electricity

- a. Static electricity or surge voltage damages LEDs..

It is recommended that a wrist band or an anti-electrostatic glove be used when handling the LEDs.

- b. All devices, equipment and machinery must be properly grounded. It is recommended that measures be taken against surge voltage to the equipment that mounts the LEDs.

Note: The specifications are subject to change without notice. Please contact us for updated information.