

571-4135 Insulated solder terminal, Pin type

Recommended mounting hole .203 (5,16)

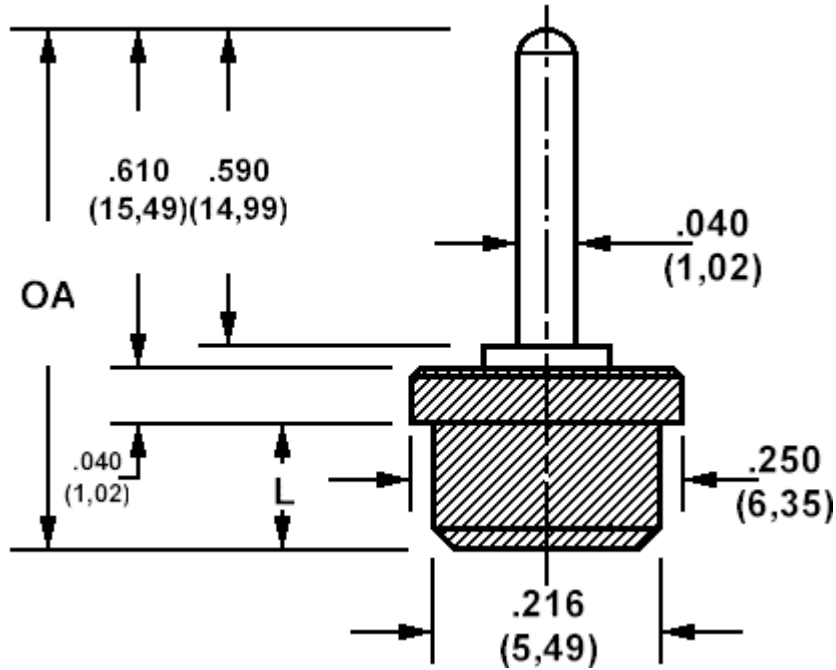

How to order code
571-4135-XX-YY-19

Basic Part No (XX = Panel thickness, YY = plating finish. See tables for options)

Basic Part No.		OA (ref)	L	Panel Thickness (XX)
571-4135	-01	.750 (19,05)	.100 (2,54)	.031 (0,79) to .062 (1,59)

Component	Material	Finish (YY)	
		-01	-05
Terminal	Brass	Silver	Electro Solder
Insulator	Teflon - white		

Additional Specifications	
Flashover VRMS at Sea Level	3000
Capacitance (pF)	0.5

Teflon is a registered trademark of Dupont