

M54519P/FP

7-UNIT 400mA DARLINGTON TRANSISTOR ARRAY

DESCRIPTION

M54519P and M54519FP are seven-circuit Darlington transistor arrays. The circuits are made of NPN transistors. Both the semiconductor integrated circuits perform high-current driving with extremely low input-current supply.

FEATURES

- High breakdown voltage ($BV_{CEO} \geq 40V$)
- High-current driving ($I_{c(max)} = 400mA$)
- Driving available with PMOS IC output
- Wide operating temperature range ($T_a = -20$ to $+75^\circ C$)

APPLICATION

Drives of relays and printers, digit drives of indication elements (LEDs and lamps), and MOS-bipolar logic IC interfaces

FUNCTION

The M54519P and M54519FP each have seven circuits consisting of NPN Darlington transistors. These ICs have resistance of $20k\Omega$ between input transistor bases and input pins. The output transistor emitters are all connected to the GND pin (pin 8).

Collector current is 400mA maximum. Collector-emitter supply voltage is 40V maximum.

The M54519FP is enclosed in a molded small flat package, enabling space-saving design.

PIN CONFIGURATION

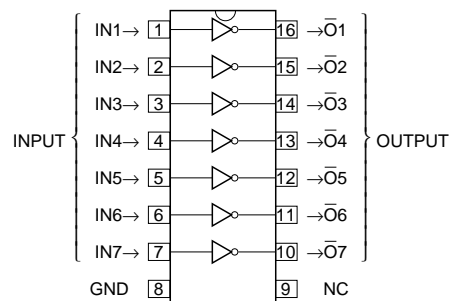

16P4(P)
Package type 16P2N-A(FP) NC : No connection

CIRCUIT DIAGRAM

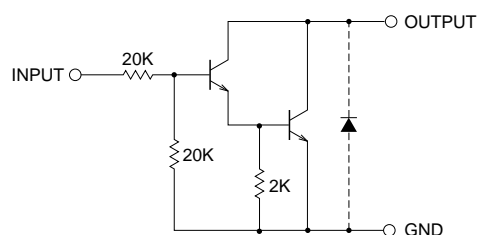

The seven circuits share the GND.

The diode, indicated with the dotted line, is parasitic, and cannot be used.

Unit : Ω

ABSOLUTE MAXIMUM RATINGS (Unless otherwise noted, $T_a = -20 \sim +75^\circ C$)

Symbol	Parameter	Conditions	Ratings	Unit
V_{CEO}	Collector-emitter voltage	Output, H	$-0.5 \sim +40$	V
I_C	Collector current	Current per circuit output, L	400	mA
V_I	Input voltage		$-0.5 \sim +40$	V
P_d	Power dissipation	$T_a = 25^\circ C$, when mounted on board	1.47(P)/1.00(FP)	W
T_{opr}	Operating temperature		$-20 \sim +75$	$^\circ C$
T_{stg}	Storage temperature		$-55 \sim +125$	$^\circ C$

M54519P/FP

7-UNIT 400mA DARLINGTON TRANSISTOR ARRAY

RECOMMENDED OPERATING CONDITIONS (Unless otherwise noted, Ta = -20 ~ +75°C)

Symbol	Parameter	Limits			Unit	
		min	typ	max		
V _o	Output voltage	0	—	40	V	
I _c	Collector current (Current per 1 circuit when 7 circuits are coming on simultaneously)	Duty Cycle P : no more than 8% FP : no more than 6%	0	—	400	mA
		Duty Cycle P : no more than 30% FP : no more than 25%	0	—	200	
V _{IH}	"H" input voltage	I _c ≤ 400mA	8	—	30	V
		I _c ≤ 200mA	5	—		
V _{IL}	"L" input voltage		0	—	0.5	V

ELECTRICAL CHARACTERISTICS (Unless otherwise noted, Ta = -20 ~ +75°C)

Symbol	Parameter	Test conditions	Limits			Unit
			min	typ*	max	
V (BR) CEO	Collector-emitter breakdown voltage	I _{CEO} = 100μA	40	—	—	V
V _{CE (sat)}	Collector-emitter saturation voltage	V _I = 8V, I _c = 400mA	—	1.3	2.4	V
		V _I = 5V, I _c = 200mA	—	1.0	1.6	
I _i	Input current	V _I = 17V	0.3	0.8	1.8	mA
hFE	DC amplification factor	V _{CE} = 4V, I _c = 400mA, Ta = 25°C	1000	6000	—	—

* : The typical values are those measured under ambient temperature (Ta) of 25°C. There is no guarantee that these values are obtained under any conditions.

SWITCHING CHARACTERISTICS (Unless otherwise noted, Ta = 25°C)

Symbol	Parameter	Test conditions	Limits			Unit
			min	typ	max	
t _{on}	Turn-on time	C _L = 15pF (note 1)	—	40	—	ns
t _{off}	Turn-off time		—	400	—	ns

NOTE 1 TEST CIRCUIT

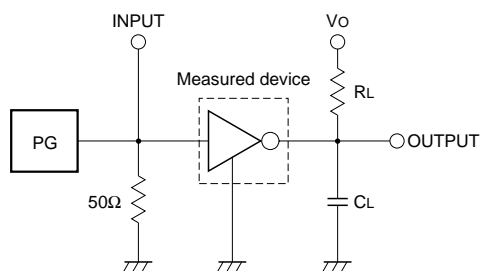

- (1) Pulse generator (PG) characteristics : PRR = 1kHz,
t_w = 10μs, t_r = 6ns, t_f = 6ns, Z_o = 50Ω
V_P = 8VP-P
- (2) Input-output conditions : R_L = 25Ω, V_O = 10V
- (3) Electrostatic capacity C_L includes floating capacitance at connections and input capacitance at probes

TIMING DIAGRAM

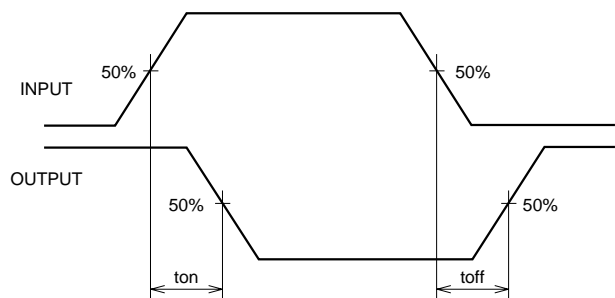

M54519P/FP

7-UNIT 400mA DARLINGTON TRANSISTOR ARRAY

TYPICAL CHARACTERISTICS

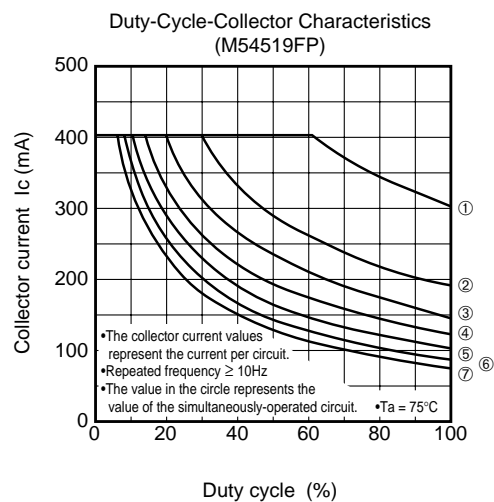
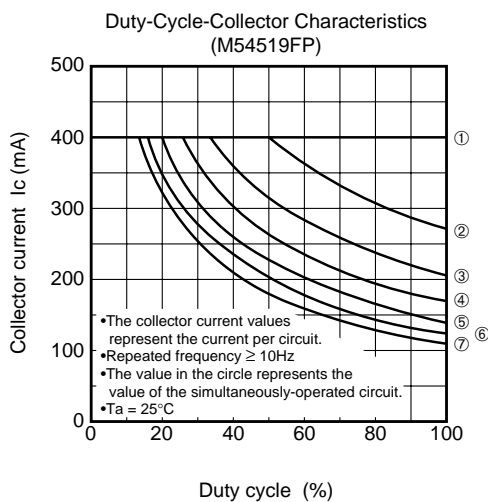
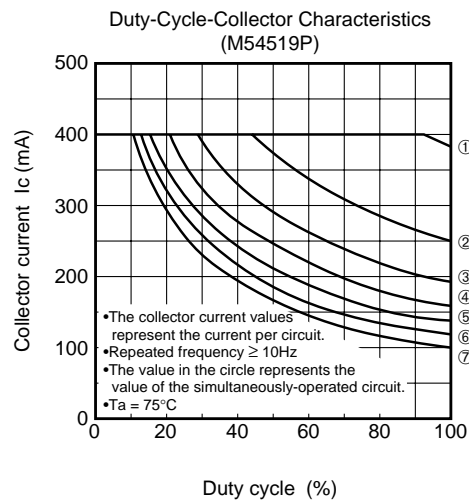
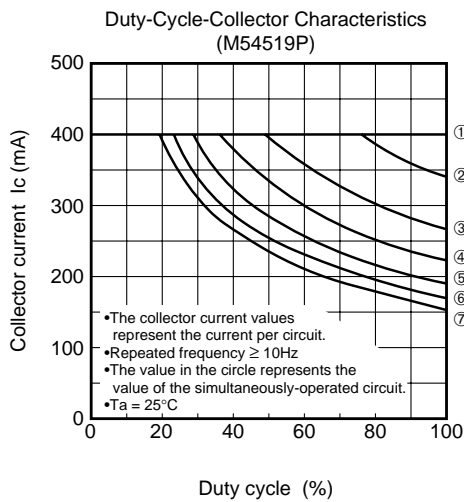
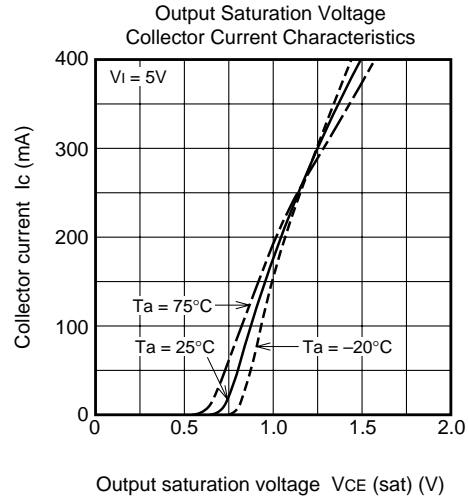
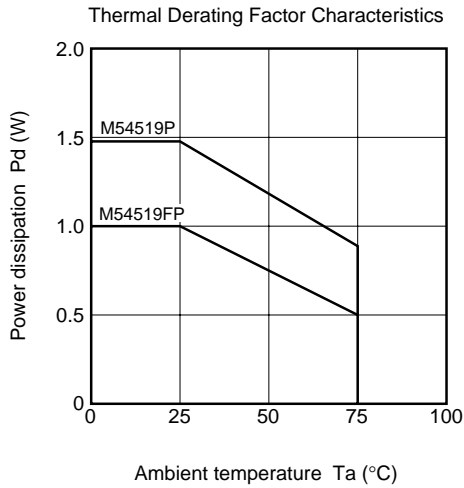

M54519P/FP

7-UNIT 400mA DARLINGTON TRANSISTOR ARRAY

