



5.0 mm DIA LED LAMP

599R2GBC-CA REV:A / 0

FEATURES

- * 5.0mm DIA LED LAMP
- * LOW POWER CONSUMPTION.
- * I.C. COMPATIBLE.
- * THREE CHIPS ARE MATCHED FOR UNIFORM LIGHT OUTPUT.
- * LONG LIFE-SOLIDSTATE RELIABILITY.
- * FULL COLOR AND HIGH CONTRAST LAMP

CHIP MATERIALS

- * Dice Material : AlGaInP/GaAs & GaInN/GaN & GaInN/GaN
- * Light Color : FULL COLOR(SUPER RED & ULTRA PURE GREEN & ULTRA BLUE)
- * Lens Color : WATER CLEAR

ABSOLUTE MAXIMUM RATING:(Ta=25°C)

SYMBOL	DESCRIPTION	SUPER RED	ULTRA PURE GREEN	ULTRA BLUE	UNIT
PAD	Power Dissipation Per Chip	70	130	120	mW
VR	Reverse Voltage Per Chip	5	5	5	V
IF	Average Forward Current Per Chip	30	30	30	mA
IPF	Peak Forward Current Per Chip (Duty=0.1,1KHZ)	60	120	70	mA
-	Derating Linear From 25°C Per Chip	0.4	0.4	0.4	mA/°C
Topr	Operating Temperature Range	-25°C to 85°C			
Tstg	Storage Temperature Range	-40°C to 85°C			
Lead Soldering Temperature { 1.6mm(0.063 inch) From Body } 260°C±5°C For 5 Seconds					

ELECTRO-OPTICAL CHARACTERISTICS:(Ta=25°C)

SYMBOL	PARAMETER	TEST CONDITION	MIN.	TYP.	MAX.	UNIT
VF	Forward Voltage	IF=20mA	Super Red	1.8	2.2	V
			Ultra Pure Green	3.5	4.0	V
			Ultra Blue	3.5	4.0	V
IR	Reverse Current	VR=5V	Super Red		100	µA
			Ultra Pure Green		100	µA
			Ultra Blue		100	µA
λD	Dominant Wavelength	IF=20mA	Super Red	625		nm
			Ultra Pure Green	525		nm
			Ultra Blue	460		nm
Δλ	Spectral Line Half-Width	IF=20mA	Super Red	20		nm
			Ultra Pure Green	22		nm
			Ultra Blue	30		nm
2θ1/2	Half Intensity Angle	IF=20mA	Super Red	85.....	100	deg
			Ultra Pure Green	85.....	100	deg
			Ultra Blue	85.....	100	deg
IV	Luminous Intensity	IF=20mA	Super Red	310.....	435	mcd
			Ultra Pure Green	770.....	1080	mcd
			Ultra Blue	200.....	390	mcd



5.0 mm DIA LED LAMP

599R2GBC-CA REV:A/0

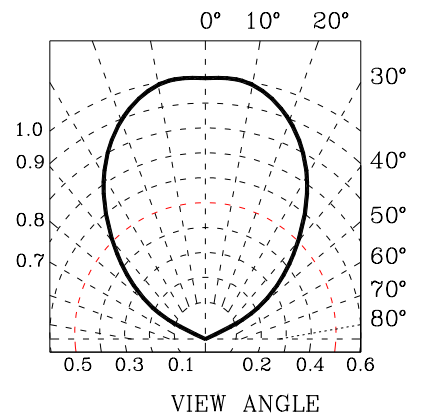
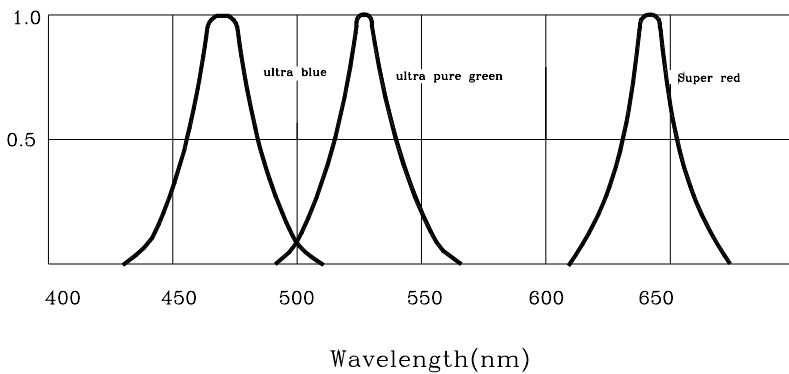
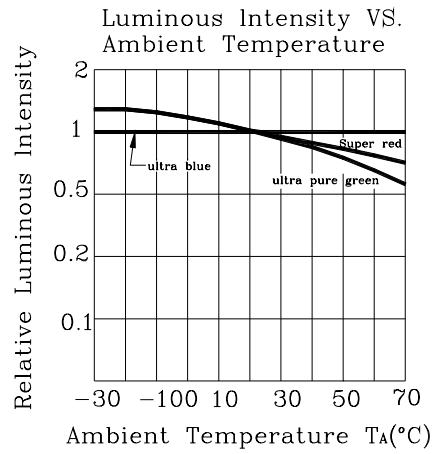
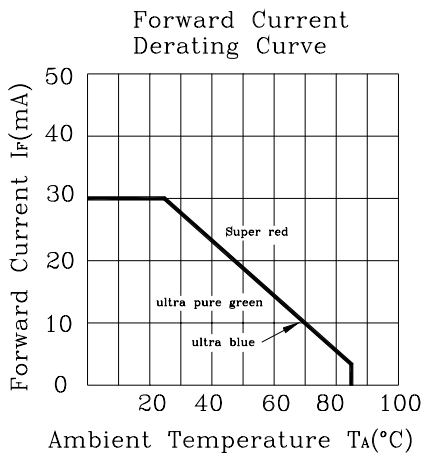
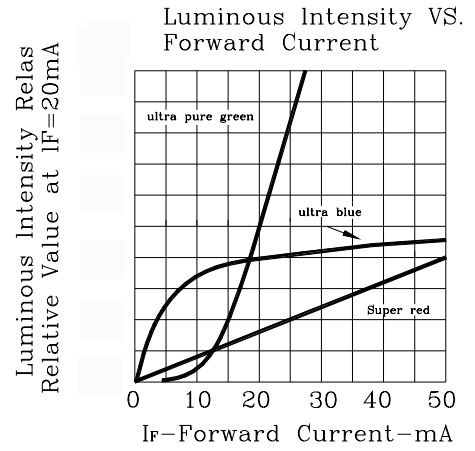
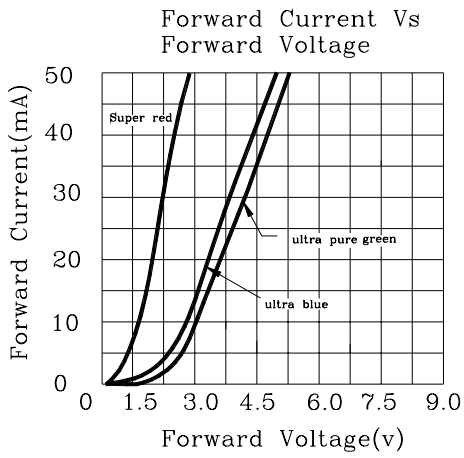



5.0 mm DIA LED LAMP

599R2GBC-CA REV:A / 0

•SOLDERING

METHOD	SOLDERING CONDITIONS	REMARK
DIP SOLDERING	Bath temperature: $260\pm 5^{\circ}\text{C}$ Immersion time: with 5 sec	<ul style="list-style-type: none">• Solder no closer than 3mm from the base of the package• Using soldering flux, "RESIN FLUX" is recommended.
SOLDERING IRON	Soldering iron: 30W or smaller Temperature at tip of iron: 260°C or lower Soldering time: within 5 sec.	<ul style="list-style-type: none">• During soldering, take care not to press the tip of iron against the lead. (To prevent heat from being transferred directly to the lead, hold the lead with a pair of tweezers while soldering

1) When soldering the lead of LED in a condition that the package is fixed with a panel (See Fig.1), be careful not to stress the leads with iron tip.

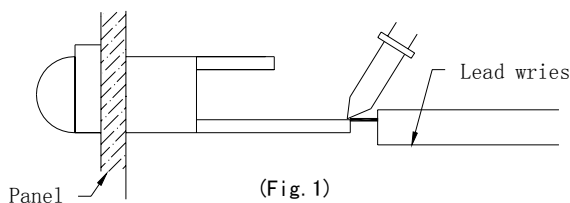

2) When soldering wire to the lead, work with a Fig (See Fig.2) to avoid stressing the package.

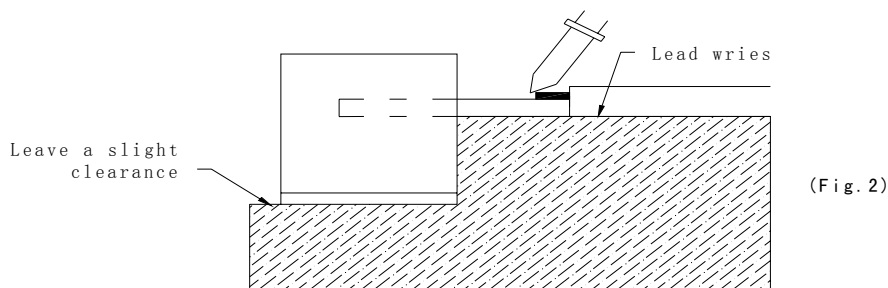



5.0 mm DIA LED LAMP

599R2GBC-CA REV:A / 0

- 3) Similarly, when a jig is used to solder the LED to PC board, take care as much as possible to avoid steering the leads (See Fig.3).

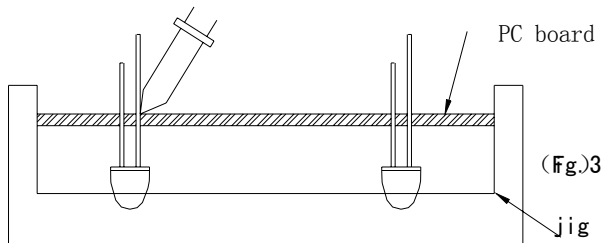

- 4) Repositioning after soldering should be avoided as much as possible. If inevitable, be sure to preserve the soldering conditions with irons stated above: select a best-suited method that assures the least stress to the LED.
- 5) Lead cutting after soldering should be performed only after the LED temperature has returned to normal temperature.

•LED MOUNTING METHOD

- 1) When mounting the LED by using a case, as shown Fig.4, ensure that the mounting holds on the PC board match the pitch of the leads correctly-tolerance of dimensions of the respective components including the LED should be taken into account especially when designing the case, PC board, etc. to prevent pitch misalignment between the leads and board holes, the diameter of the board holes should be slightly larger than the size of the lead. Alternatively, the shape of the holes should be made oval. (See Fig.4)

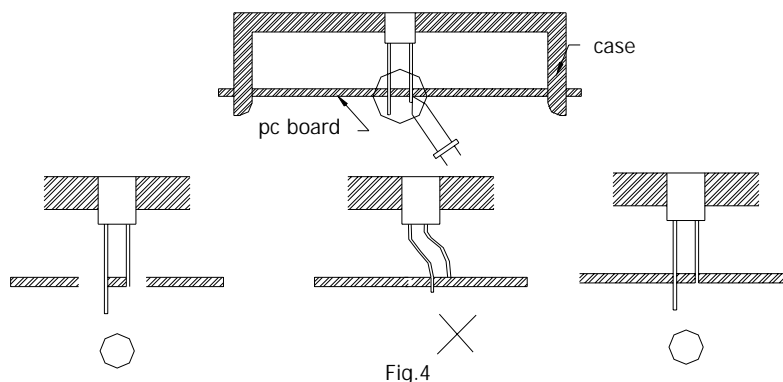



5.0 mm DIA LED LAMP

599R2GBC-CA REV:A / 0

2) Use LEDs with stand-off (Fig.5) or the tube or spacer made of resin (Fig.6) to position the LEDs.

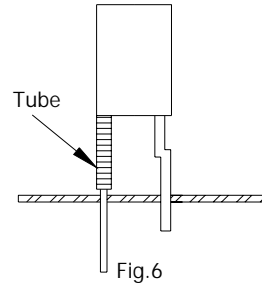
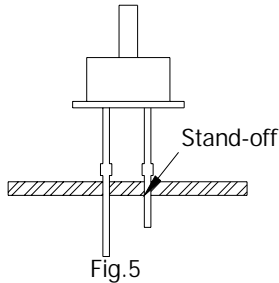

•FORMED LEAD

1) The lead should be bent at a point located at least 2mm away from the package. Bending should be performed with base fixed means of a jig or pliers (Fig.7)

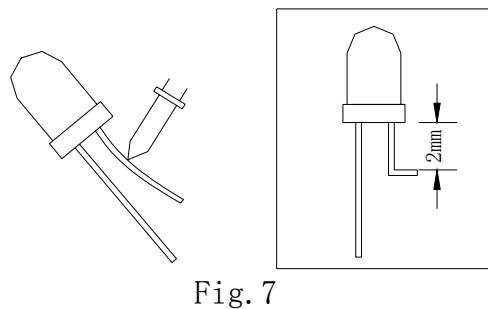

2) Forming lead should be carried out prior to soldering and never during or after soldering.
3) Form the lead to ensure alignment between the leads and the hole on board, so that stress against the LED is prevented. (Fig.8)

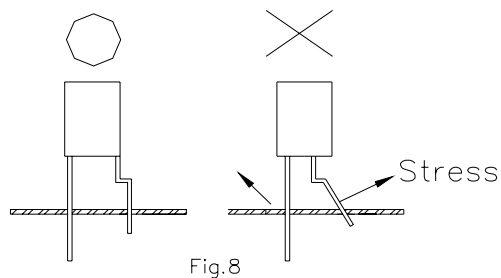



5.0 mm DIA LED LAMP

599R2GBC-CA REV:A / 0

•LEAD STRENGTH

1) Bend strength

Do not bend the lead more than twice. (Fig.9)

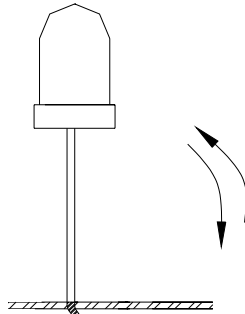

Fig.9

2) Tensile strength (@Room Temperature)

If the force is 1kg or less, there will be no problem. (Fig.10)

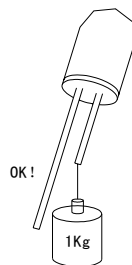

Fig.10

•HANDLING PRECAUTIONS

Although rigid against vibration, the LEDs may damaged or scratched if dropped. So take care when handling.

•CHEMICAL RESISTANCE

- 1) Avoid exposure to chemicals as it may attack the LED surface and cause discoloration.
- 2) When washing is required, refer to the following table for the proper chemical to be sued. (Immersion time: within 3 minutes at room temperature.)

SOLVENT	ADAPTABILITY
Freon TE	⊙
Chlorothene	×
Isopropyl Alcohol	⊙
Thinner	×
Acetone	×
Trichloroethylene	×

⊙--Usable ×--Do not use.

NOTE: Influences of ultrasonic cleaning of the LED resin body differ depending on such factors as the oscillator output, size of the PC board and the way in which the LED is mounted.

Therefore, ultrasonic cleaning should only be performed after confirming there is no problem by



5.0 mm DIA LED LAMP

599R2GBC-CA REV:A/0

Experiment Item:

Item	Test Condition	Reference Standard
	Lamp & IR	
OPERATION LIFE	Ta : 25±5°C IF= 20mA RH : ≤60%RH ① DYNAMIC:100mA 1ms 1/10 duty ② STATIC STATE: IF= 20mA TEST TIME: 168HRS (-24HRS , +24HRS) 500HRS (-24HRS , +24HRS) 1000HRS (-24HRS , +72HRS)	MIL-STD-750 : 1026 MIL-STD-883 : 1005 JIS C 7021 : B-1
HIGH TEMPERATURE HIGH HUMIDITY STORAGE	Ta : 65°C±5°C RH : 90~95%RH TEST TIME : 240HRS±2HRS	MIL-STD-202 : 103B JIS C 7021 : B-1
TEMPERATURE CYCLING	105°C~25°C~-55°C~25°C 30min 5min 30min 5min 10CYCLES	MIL-STD-202 : 107D MIL-STD-750 : 1051 MIL-STD-883 : 1010 JIS C 7021 : A-4
THERMAL SHOCK	105°C±5°C~-55°C±5°C 10min 10min 10CYCLES	MIL-STD-202 : 107D MIL-STD-750 : 1051 MIL-SYD-883 : 1011
SOLDER RESISTANCE	T , sol : 260°C±5°C DWELL TIME : 10±1sec	MIL-STD-202 : 210A MIL-STD-750-2031 JIS C 7021 : A-1
SOLDERABILITY	T , sol : 230°C±5°C DWELL TIME : 5±1sec	MIL-STD-202 : 208D MIL-STD-750 : 2026 MIL-STD-883 : 2003 JIS C 7021 : A-2