

Evaluation Kit
Available

MAXIM

5A/2A Step-Down, PWM, Switch-Mode DC-DC Regulators

General Description

The MAX724/MAX726 are monolithic, bipolar, pulse-width modulation (PWM), switch-mode DC-DC regulators optimized for step-down applications. The MAX724 is rated at 5A, and the MAX726 at 2A. Few external components are needed for standard operation because the power switch, oscillator, and control circuitry are all on-chip. Employing a classic buck topology, these regulators perform high-current step-down functions, but can also be configured as inverters, negative boost converters, or flyback converters.

These regulators have excellent dynamic and transient response characteristics, while featuring cycle-by-cycle current limiting to protect against overcurrent faults and short-circuit output faults. The MAX724/MAX726 also have a wide 8V to 40V input range (up to 60V for the high-voltage "H" version) in the buck step-down configuration. In inverting and boost configurations, the input can be as low as 5V.

The MAX724/MAX726 are available in 5-pin TO-220, 7-pin TO-220, and 4-pin TO-3 packages. The MAX726 is also available in 16-pin SOIC. These devices have a preset 100kHz oscillator frequency and a preset current limit of 6.5A (MAX724) or 2.6A (MAX726). The 7-pin and 16-pin packages allow for adjustable current limit and micropower shutdown.

Applications

Distributed Power from High-Voltage Buses
High-Current, High-Voltage Step-Down Applications
High-Current Inverter
Negative Boost Converter
Multiple-Output Buck Converter
Isolated DC-DC Conversion

Typical Operating Circuit

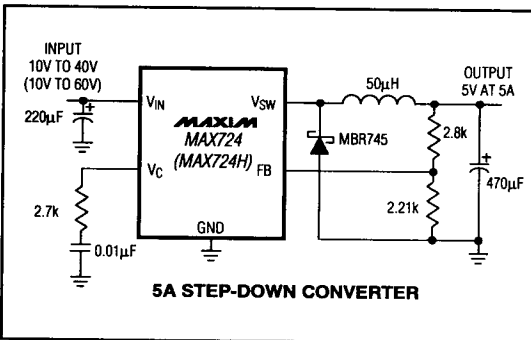

Features

- ◆ Input Range: Up to 40V
Up to 60V (H Version)
- ◆ 5A On-Chip Power Switch (MAX724)
2A On-Chip Power Switch (MAX726)
- ◆ Adjustable Output: 2.5V to 40V
2.5V to 50V (H Version)
- ◆ 100kHz Switching Frequency
- ◆ Excellent Dynamic Characteristics
- ◆ Few External Components
- ◆ 8.5mA Quiescent Current
- ◆ TO-220 and TO-3 Packages
- ◆ 16-Pin SOIC Package (MAX726 only)

Ordering Information

PART	TEMP. RANGE	PIN-PACKAGE
MAX724CCK	0°C to +70°C	5 TO-220
MAX724CCM	0°C to +70°C	7 TO-220†
MAX724CKS	0°C to +70°C	4 TO-3†
MAX724ECK	-40°C to +85°C	5 TO-220
MAX724ECM	-40°C to +85°C	7 TO-220†
MAX724EKS	-40°C to +85°C	4 TO-3†
MAX724MKS	-55°C to +125°C	4 TO-3†

Ordering Information continued on last page.

* Contact factory for dice specifications.

† Contact factory for package availability.

Pin Configurations

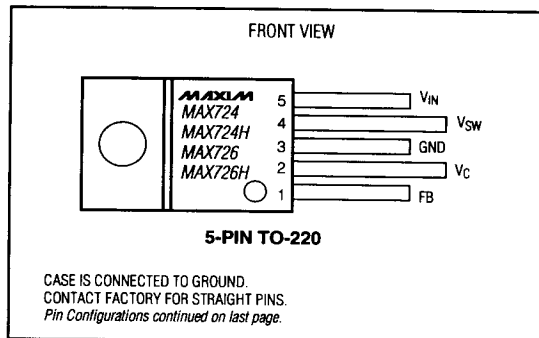

MAX724/MAX726

4

MAXIM

Maxim Integrated Products 4-79

Call toll free 1-800-998-8800 for free samples or literature.

5A/2A Step-Down, PWM, Switch-Mode DC-DC Regulators

ABSOLUTE MAXIMUM RATINGS

Input Voltage	
MAX724/MAX726	45V
MAX724H/MAX726H	64V
Switch Voltage with Respect to Input Voltage	
MAX724/MAX726	64V
MAX724H/MAX726H	75V
Switch Voltage with Respect to Ground Pin (V_{SW} Negative)	
MAX724/MAX726 (Note 8)	35V
MAX724H/MAX726H (Note 8)	45V
Feedback Pin Voltage	-0.3V, +10V
Shutdown Pin Voltage (not to exceed V_{IN})	40V
I_{LIM} Pin Voltage (forced)	5.5V

Operating Temperature Ranges:	
MAX72_C_/HC_	0°C to +70°C
MAX72_E_/HE_	-40°C to +85°C
MAX72_MKS/HMKS	-55°C to +125°C
Junction Temperature Ranges:	
MAX72_C_/HC_	0°C to +125°C
MAX72_E_/HE_	-40°C to +85°C
MAX72_MKS/HMKS	-55°C to +150°C
Storage Temperature Range	-65°C to +160°C
Lead Temperature (soldering, 10 sec)	+300°C

Stresses beyond those listed under "Absolute Maximum Ratings" may cause permanent damage to the device. These are stress ratings only, and functional operation of the device at these or any other conditions beyond those indicated in the operational sections of the specifications is not implied. Exposure to absolute maximum rating conditions for extended periods may affect device reliability.

ELECTRICAL CHARACTERISTICS

($V_{IN} = 25V$, $T_J = T_{MIN}$ to T_{MAX} , unless otherwise noted.)

PARAMETER	CONDITIONS		MIN	TYP	MAX	UNITS
Switch-On Voltage (Note 1)	MAX724	$I_{SW} = 1A$	$T_J \geq 0^\circ C$		1.85	V
			$T_J < 0^\circ C$		2.10	
		$I_{SW} = 5A$	$T_J \geq 0^\circ C$		2.30	
			$T_J < 0^\circ C$		2.50	
	MAX726	$I_{SW} = 0.5A$	$T_J = T_{MIN}$ to T_{MAX}		1.2	
		$I_{SW} = 2A$	$T_J = T_{MIN}$ to T_{MAX}		1.7	
Switch-Off Leakage	MAX724	$V_{IN} \leq 25V$, $V_{SW} = 0V$	$T_J = +25^\circ C$	5	300	μA
			$T_J = +25^\circ C$	10	500	
	MAX726	$V_{IN} \leq 25V$, $V_{SW} = 0V$	$T_J = +25^\circ C$		150	
			$T_J = +25^\circ C$		250	
Supply Current (Note 3)	$V_{FB} = 2.5V$, $V_{IN} \leq 40V$			8.5	11	mA
	H version only, $40V < V_{IN} < 60V$			9	12	
	$V_{SHUT} = 0.1V$ (Note 4)			140	300	μA
Minimum Operating Supply Voltage				7.3	8.0	V
Minimum Start-Up Supply Voltage (Note 5)			$T_A \geq +25^\circ C$	3.5	4.8	V
			$T_A < +25^\circ C$	3.5	5.0	

5A/2A Step-Down, PWM, Switch-Mode DC-DC Regulators

MAX724/MAX726

ELECTRICAL CHARACTERISTICS (continued)

($V_{IN} = 25V$, $T_j = T_{MIN}$ to T_{MAX} , unless otherwise noted.)

PARAMETER	CONDITIONS			MIN	TYP	MAX	UNITS
Switch Current Limit (Note 6)	MAX724	I_{LIM} open	$T_j = T_{MIN}$ to T_{MAX}	5.5	6.5	8.5	A
		$R_{LIM} = 10k\Omega$ (Note 7)	$T_j = +25^\circ C$	4.5			
		$R_{LIM} = 7k\Omega$ (Note 7)	$T_j = +25^\circ C$	3			
	MAX726	I_{LIM} open	$T_j = T_{MIN}$ to T_{MAX}	2	2.6	3.2	
		$R_{LIM} = 10k\Omega$ (Note 7)	$T_j = +25^\circ C$	1.8			
		$R_{LIM} = 7k\Omega$ (Note 7)	$T_j = +25^\circ C$	1.2			
Maximum Duty Cycle				85	90		%
Switching Frequency				90	100	110	kHz
	$T_j \leq +125^\circ C$			85	120		
	$T_j > +125^\circ C$			85	125		
	$V_{FB} =$ grounded through $2k\Omega$ (Note 6)			20			
Switching Frequency Line Regulation	$8V \leq V_{IN} \leq V_{MAX}$ (Note 2)			0.03	0.1		%/V
Error-Amplifier Voltage Gain (Note 8)	$1V \leq V_C \leq 4V$			2000			V/V
Error-Amplifier Transconductance	$T_j = +25^\circ C$			3700	5000	8000	μmho
Error-Amplifier Source Current	$V_{FB} = 2V$			100	140	225	μA
Error-Amplifier Sink Current	$V_{FB} = 2.5V$			0.7	1.0	1.6	mA
Feedback Pin Bias Current	$V_{FB} = V_{REF}$			0.5		2	μA
Reference Voltage	$V_C = 2V$			2.155	2.210	2.265	V
Reference Voltage Tolerance	V_{REF} (nominal) = 2.21V			± 0.5		± 1.5	%
	All conditions of input voltage, output voltage, temperature and load current			± 1.0		± 2.5	
Reference Voltage Line Regulation	$8V \leq V_{IN} \leq V_{MAX}$ (Note 2)			0.005	0.02		%/V
VC Voltage at 0% Duty Cycle	$T_j = +25^\circ C$			1.5			V
	$T_j = T_{MIN}$ to T_{MAX}			-4			mV/ $^\circ C$
Shutdown Pin Current	$V_{SHUT} = 5V$			5	10	20	μA
	$V_{SHUT} \leq V_{THRESHOLD}$ ($\approx 2.5V$)					50	
Shutdown Thresholds	Switch duty cycle = 0%			2.2	2.45	2.7	V
	Fully shut down			0.1	0.3	0.5	
Thermal Resistance Junction to Case (Note 9)	MAX724					2.5	$^\circ C/W$
	MAX726					4.0	

4

Note 1: For switch currents between 1A and 5A (2A for MAX726), maximum switch on voltage can be calculated via linear interpolation.

Note 2: $V_{MAX} = 40V$ for MAX724/MAX726 and $60V$ for MAX724H/MAX726H.

Note 3: By setting the feedback pin (FB) to 2.5V, the V_C pin is forced to its low clamp level and the switch duty cycle is forced to zero, approximating the zero load condition.

Note 4: Device shutdown. Switch leakage current not included.

Note 5: For proper regulation, total voltage from V_{IN} to GND must be $\geq 8V$ after start-up.

Note 6: To avoid extremely short switch-on times, the switch frequency is internally scaled down when V_{FB} is less than 1.3V. Switch current limit is tested with V_{FB} adjusted to give a $1\mu s$ minimum switch-on time.

Note 7: For MAX724, $R_{LIM} = \left[\frac{I_{LIM}}{1A} \times 2k\Omega \right] + 1k\Omega$. For MAX726, $R_{LIM} = \left[\frac{I_{LIM}}{1A} \times 5.5k\Omega \right] + 1k\Omega$. Refer to Adjustable Current Limit section.

Note 8: Do not exceed switch-to-input voltage limitation.

Note 9: Guaranteed, not production tested.



5A/2A Step-Down, PWM, Switch-Mode DC-DC Regulators

Typical Operating Characteristics

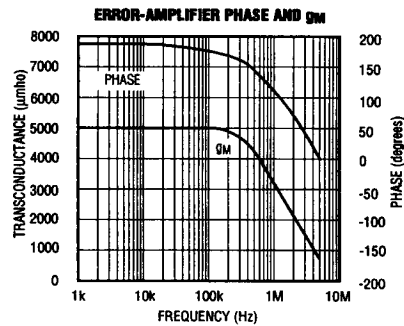
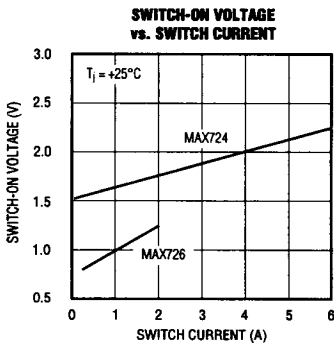
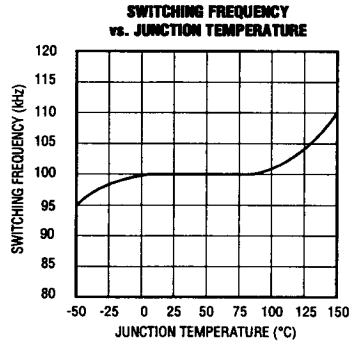
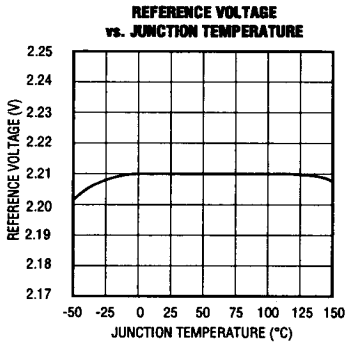
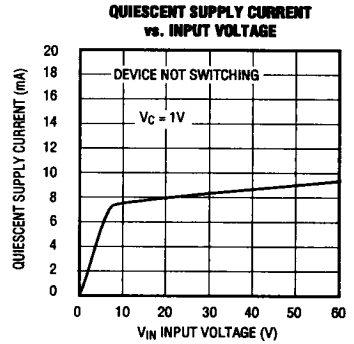
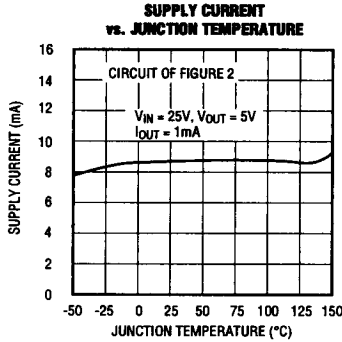
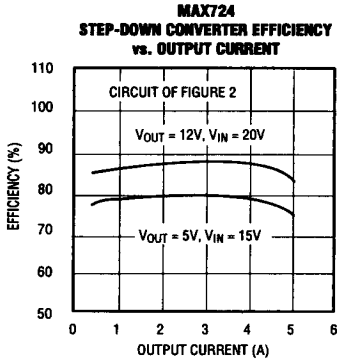

5A/2A Step-Down, PWM, Switch-Mode DC-DC Regulators

Typical Operating Characteristics (continued)

MAX724/MAX726

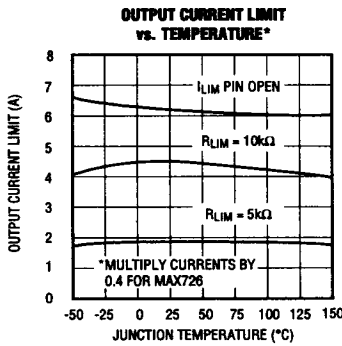
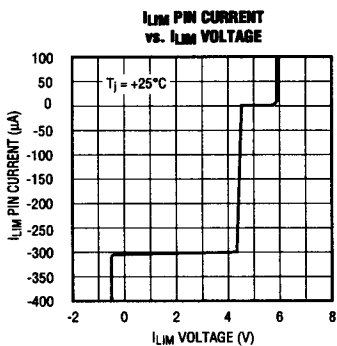
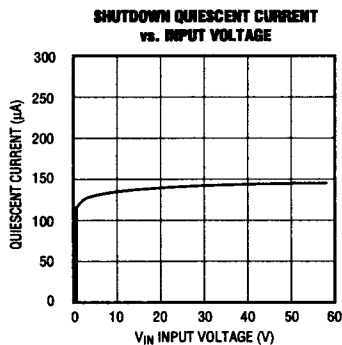
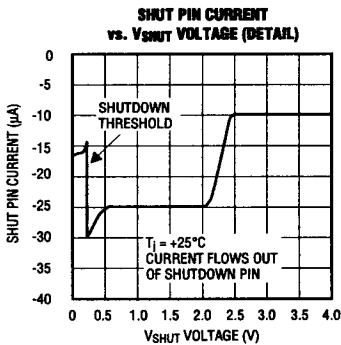
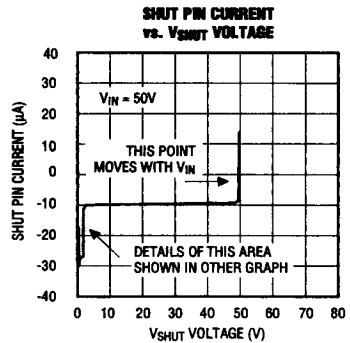
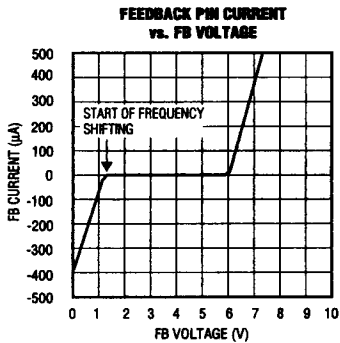
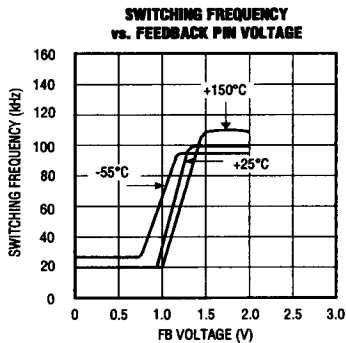

5A/2A Step-Down, PWM, Switch-Mode DC-DC Regulators

Pin Description

PIN				NAME	FUNCTION
5-PIN TO-220	4-PIN TO-3	7-PIN TO-220	16-PIN SO		
1	4	5	8	FB	Feedback Input is the error amplifier's inverting input, and controls output voltage by adjusting switch duty cycle. Input bias current is typically 0.5 μ A when the error amplifier is balanced ($I_{OUT} = 0V$). FB also aids current limiting by reducing the oscillator frequency when the output voltage is low. (See the <i>Applications Information</i> section.)
2	1	6	11	V_C	Error-Amplifier Output. A series RC network connected to this pin compensates the MAX724/MAX726. Output swing is limited to about 5.8V in the positive direction and -0.7V in the negative direction. V_C can also synchronize the MAX724/MAX726 to an external clock. (See the <i>Applications Information</i> section).
3	CASE	4	5, 7, 10, 12	GND	Ground requires a short low-noise connection to ensure good load regulation. The internal reference is referred to GND, so errors at this pin are multiplied by the error amplifier. See the <i>Applications Information</i> section for grounding details.
4	3	2	13, 14, 15, 16	V_{SW}	Internal Power Switch Output. The switch output can swing 40V below ground and is rated for 5A (MAX724), 2A (MAX726).
5	2	1	1, 2, 3, 4	V_{IN}	V_{IN} supplies power to the MAX724/MAX726's internal circuitry and also connects to the collector. V_{IN} must be bypassed with a low-ESR capacitor, typically 200 μ F or 220 μ F.
-	-	3	6	I_{LIM}	Switch current limit can be reduced by connecting an external resistor (R_{LIM}) from I_{LIM} to GND (7-pin and 16-pin versions only).
-	-	7	9	SHUT	Shutdown is achieved by pulling SHUT low (7-pin and 16-pin versions only). Below 2.45V turns off the switch. Below 0.3V forces total device shutdown.

5A/2A Step-Down, PWM, Switch-Mode DC-DC Regulators

MAX724/MAX726

Detailed Description

The MAX724/MAX726 are complete, single-chip, pulse-width modulation (PWM), step-down DC-DC converters (Figure 1). All oscillator (100kHz), control, and current-limit circuitry, including a 5A power switch (2A for MAX726), are included on-chip. The oscillator turns on the switch (V_{SW}) at the beginning of each clock cycle. The switch turns off at a point later in the clock cycle, which is a function of the signal provided by the error amplifier. The maximum switch duty cycle is approximately 93% at the MAX724/MAX726's 100kHz switching frequency.

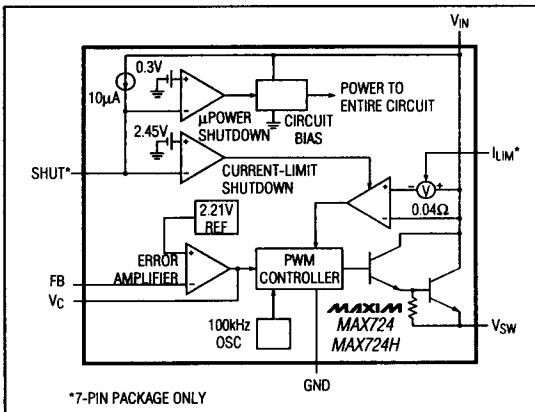

Figure 1. MAX724 Block Diagram

Both the input (FB) and output (V_C) of the error amplifier are brought out to simplify compensation. Most applications require only a single series RC network connected from V_C to ground. The error amplifier is a transconductance amplifier with a g_m of approximately 5000µmho. When slewing, V_C can source about 140µA, and sink about 1.1mA. This asymmetry helps minimize start-up overshoot by allowing the amplifier output to slew more quickly in the negative direction.

Current limiting is provided by the current-limit comparator. If the current-limit threshold is exceeded, the switch cycle terminates within about 600ns. The current-limit threshold is internally set to approximately 6.5A (2.6A for MAX726). V_{SW} is a power NPN, internally driven by the PWM controller circuitry. V_{SW} can swing 40V below ground and is rated for 5A (2A for MAX726).

On the 7-pin and 16-pin versions, the current limit can be adjusted using the I_{LIM} pin, and shutdown can be activated with the SHUT pin.

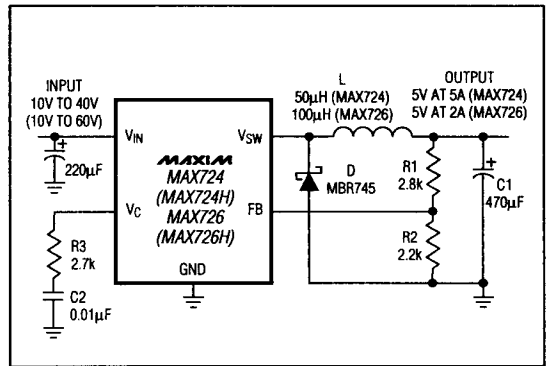

Figure 2. Basic Step-Down Converter

Basic Step-Down Application

Figure 2 shows the MAX724/MAX726 in a basic step-down DC-DC converter. Typical MAX724 waveforms are shown in Figure 3 for $V_{IN} = 20V$, $V_{OUT} = 5V$, $L = 50\mu H$, and $I_{OUT} = 3A$ and 0.16A. Two sets of waveforms are shown. One set shows high load current (3A) where inductor current never falls to zero during the switch "off-cycle" (continuous-conduction mode, CCM). The second set of waveforms, at low output current (0.16A), shows inductor current at zero during the latter half of the switch off-cycle (discontinuous-conduction mode, DCM). The transition from CCM to DCM occurs at an output current (I_{DCM}) that can be derived with the following equation:

$$I_{DCM} = \frac{(V_{OUT} + V_D) [(V_{IN} - V_{SW}) - (V_{OUT} + V_D)]}{2 (V_{IN} - V_{SW}) f_{OSC} L}$$

where V_D is the diode forward voltage drop, V_{SW} is the voltage drop across the switch, and $f_{OSC} = 100kHz$. In most applications, the distinction between CCM and DCM is academic since actual performance differences are minimal. All CCM designs can be expected to exhibit DCM behavior at some level of reduced load current.

In DCM, ringing occurs at V_{SW} in the latter part of the switch off-cycle. This is due to the inductor resonating with the parallel capacitance of the catch diode and the V_{SW} node. This ringing is harmless and does not appear at the output. Furthermore, attempts to damp this ringing by adding circuitry will reduce efficiency and are not advised. No off-state ringing occurs in CCM because the diode always conducts during the switch-off time and consequently damps any resonance at V_{SW} .

5A/2A Step-Down, PWM, Switch-Mode DC-DC Regulators

Component Selection

Table 1 lists component suppliers for inductors, capacitors, and diodes appropriate for use with the MAX724/MAX726. Be sure to observe specified ratings for all components.

Table 1. Component Suppliers

Surface-Mount Components (for designs typically below 2A)

Inductors:	Sumida Electric - CDR125 Series
	USA: Phone (708) 956-0666
	Japan: Phone (03) 3607-5111
	FAX (03) 3607-5428
Coiltronics - CTX series	USA: Phone (305) 781-8900
	FAX (305) 782-4163
Capacitors:	Matsuo - 267 series
	USA: Phone (714) 969-2491
	FAX (714) 960-6492
	Japan: Phone (06) 332-0871
	Sprague - 595D series
	USA: Phone (603) 224-1961
FAX (603) 224-1430	
Diodes:	Motorola - MBRS series
	USA: (602) 244-6900
	Nihon - NSQ series
	USA: Phone (805) 867-2555
	FAX (805) 867-2698

Through-Hole Components

Inductors:	Sumida - RCH-110 series
	(see above for phone number)
	Cadell-Burns - 7070, 7300, 6860, and 7200 series
	USA: Phone (516) 746-2310
	FAX (516) 742-2416
	Renco - various series
	USA: Phone (516) 586-5566
	FAX (516) 586-5562
	Coiltronics - various series
	(see above for phone number)
Capacitors:	Nichicon - PL series low-ESR electrolytics
	USA: Phone (708) 843-7500
	FAX (708) 843-2798
	United Chemi-Con - LXF series
	USA: Phone (708) 696-2000
	FAX (708) 640-6311
	Sanyo - OS-CON low-ESR organic semiconductor
	USA: Phone (619) 661-6322
	Japan: Phone (0720) 70-1005
	FAX (0720) 70-1174
Diodes:	General Purpose - 1N5820-1N5825
	Motorola - MBR and MBRD series
	(see above for phone number)

Inductor Selection

Although most MAX724 designs perform satisfactorily with 50 μ H inductors (100 μ H for the MAX726), the MAX724/MAX726 are able to operate with values ranging from 5 μ H to 200 μ H. In some cases, inductors other than 50 μ H may be desired to minimize size (lower inductance), or reduce ripple (higher inductance). In any case, inductor current must at least be rated for the desired output current.

In high-current applications, pay particular attention to both the RMS and peak inductor ratings. The inductor's peak current is limited by core saturation. Exceeding the saturation limit actually reduces the coil's inductance and energy storage ability, and increases power loss. Inductor RMS current ratings depend on heating effects in the coil windings.

The following equation calculates maximum output current as a function of inductance and input conditions:

$$I_{OUT} = I_{SW} - \frac{V_{OUT} (V_{IN} - V_{OUT})}{2 f_{OSC} V_{IN} L}$$

where I_{SW} is the maximum switch current (5.5A for MAX724), V_{IN} is the maximum input voltage, V_{OUT} is the output voltage, and f_{OSC} is the switching frequency.

For the MAX724 example in Figure 2, with $L = 50\mu\text{H}$ and $V_{IN} = 25\text{V}$,

$$I_{OUT} = 5.5\text{A} - \frac{5\text{V} (25\text{V} - 5\text{V})}{2 (10^5\text{Hz}) 25\text{V} (50 \times 10^{-6}\text{H})} = 5.1\text{A}$$

Note that increasing or decreasing inductor value provides only small changes in maximum output current (100 μ H = 5.3A, 20 μ H = 4.5A). The equation shows that output current is mostly a function of the MAX724/MAX726 current-limit value. Again, a 50 μ H inductor works well in most applications and provides 5A with a wide range of input voltages.

Catch Diode

D1 provides a path for inductor current when V_{SW} turns off. Under normal load conditions, the average diode current may only be a fraction of load current; but during short-circuit or current-limit, diode current is higher. Conservative design dictates that the diode average current rating be 2 times the desired output current. If operation with extended short-circuit or overload time is expected, then the diode current rating must exceed the current limit (6.5A = MAX724, 2.6A = MAX726), and heat sinking may be necessary.

5A/2A Step-Down, PWM, Switch-Mode DC-DC Regulators

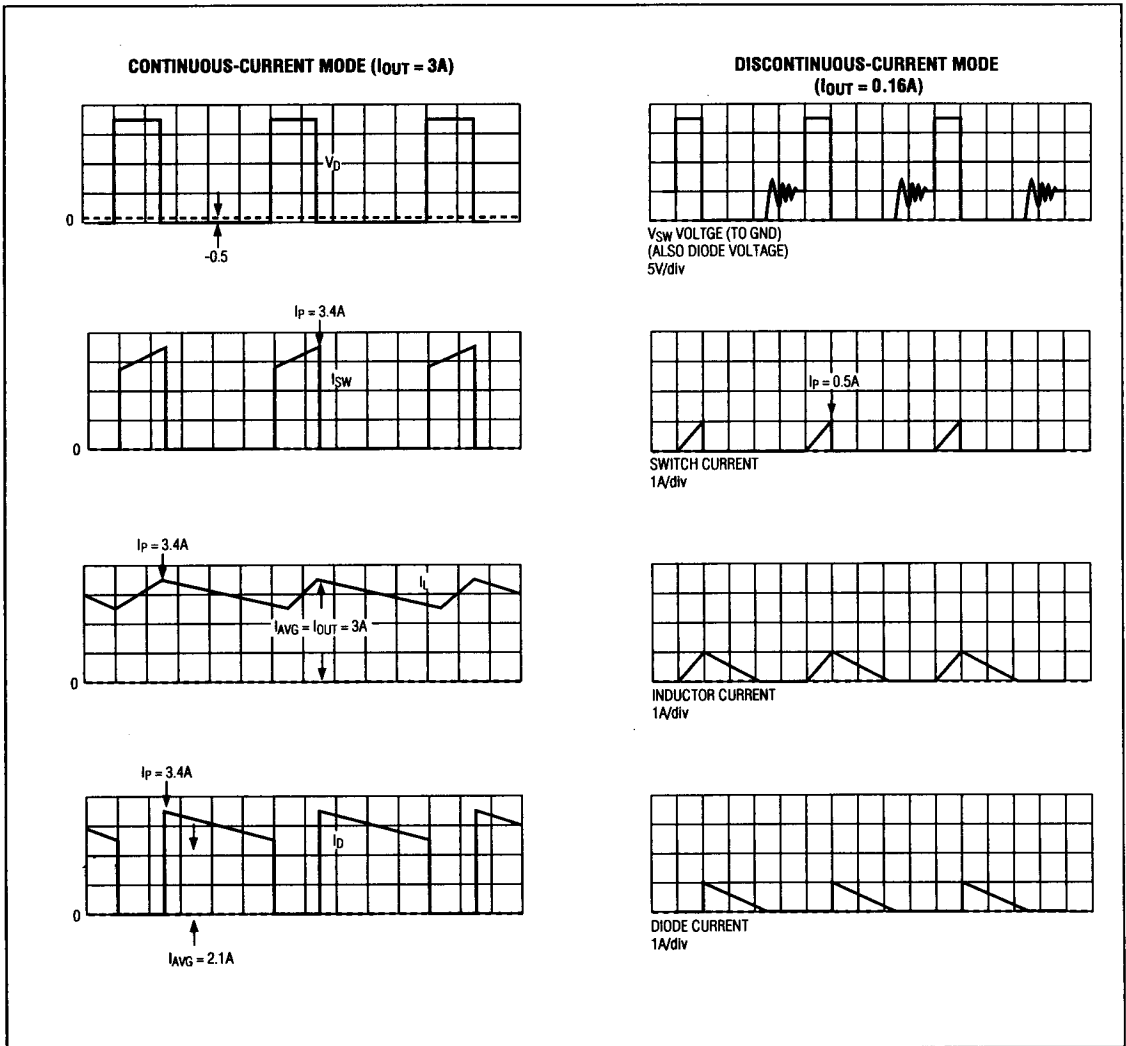

Figure 3. MAX724 Step-Down Converter Waveforms with $V_{IN} = 20V$, $L = 50\mu H$ (all waveforms $2\mu s/div$)

5A/2A Step-Down, PWM, Switch-Mode DC-DC Regulators

Under normal operating conditions (not shorted), power dissipated in the diode P_D is calculated by:

$$P_D = I_{OUT} \frac{(V_{IN} - V_{OUT}) V_D}{V_{IN}}$$

where V_D is forward drop of the diode at a current equal to I_{OUT} . In nearly all circuits, Schottky diodes provide the best performance and are recommended due to their fast switching times and low forward voltage drop. Standard power rectifiers such as the 1N4000 series are too slow for DC-DC conversion circuits and are **not** recommended.

Output Filter Capacitor

For most MAX724/MAX726 applications, a high-quality, low-ESR, 470 μ F or 500 μ F output filter capacitor will suffice. To reduce ripple, minimize capacitor lead length and connect the capacitor directly to the GND pin. Capacitor suppliers are listed in Table 1. Output ripple is a function of inductor value and output capacitor effective series resistance (ESR). In continuous-conduction mode:

$$V_{CR(p-p)} = \frac{ESR (V_{OUT}) (1 - V_{OUT}/V_{IN})}{L f_{OSC}}$$

It is interesting to note that input voltage (V_{IN}), and not load current, affects output ripple in CCM. This is because only the DC, and not the peak-to-peak, inductor current changes with load (see Figure 3).

In discontinuous-conduction mode, the equation is different because the peak-to-peak inductor current does depend on load:

$$V_{DR(p-p)} = ESR \sqrt{2 \frac{I_{OUT} V_{OUT} (V_{IN} - V_{OUT})}{L f_{OSC} V_{IN}}}$$

where output ripple is proportional to the square root of load current. Refer to the earlier equation for I_{DCM} to determine where DCM occurs and hence when the DCM ripple equation should be used.

Input Bypass Capacitor

An input capacitor (200 μ F or 220 μ F) is required for step-down converters because the input current, rather than being continuous (like output current), is a square wave. For this reason the capacitor must have low ESR and a ripple-current rating sufficiently large so that its ESR and the AC input current do not conspire to overheat the capacitor. In CCM, the capacitor's RMS ripple current is:

$$I_{R(RMS)} = I_{OUT} \sqrt{\frac{V_{OUT} (V_{IN} - V_{OUT})}{V_{IN}^2}}$$

The power dissipated in the input capacitor is then P_C :

$$P_C = I_{R(RMS)}^2 (ESR)$$

Be sure that the selected capacitor can handle the ripple current over the required temperature range. Also locate the input capacitor very close to the MAX724/MAX726 and use minimum length leads (surface-mount or radial through-hole types). In most applications, ESR is more important than actual capacitance value since electrolytic capacitors are mostly resistive at the MAX724/MAX726's 100kHz switching frequency.

Applications Information

Setting Output Voltage

R1 and R2 set output voltage as follows:

$$R1 = \frac{V_{OUT} R2}{2.21V} - R2$$

2.21V is the reference voltage, so setting R2 to 2.21k Ω (standard 1% resistor value) results in 1mA flowing through R1 and R2 and simplifies the above equation. Other values will also work for R2, but should not exceed 4k Ω .

Synchronizing the Oscillator

The MAX724/MAX726 can be synchronized to an external 110kHz to 160kHz source by pulsing the V_C pin to ground at the desired clock rate. This is conveniently done with the collector of an external grounded-emitter NPN transistor. V_C should be pulled low for 300ns. Doing this may have some impact on output regulation, but the effect should be minimal for compensation resistor values between 1k Ω and 4k Ω .

Power Dissipation

The MAX724/MAX726 draw about 7.5mA operating current, which is largely independent of input voltage or load current. They draw an additional 5mA during switch on-time. Power dissipated in the internal V_{SW} transistor is proportional to load current and depends on both conduction losses (product of switch on-voltage and switch current) and dynamic switching losses (due to switch rise and fall times). Total MAX724 power dissipation can be calculated as follows:

$$P = V_{IN} [7.5mA + 5mA (DC) + 2 I_{OUT} t_{sw} f_{osc}] + \dots$$

$$\dots DC [I_{OUT} (1.8V) + 0.1\Omega (I_{OUT})^2]$$

$$DC = \text{Duty Cycle} = \frac{V_{OUT} + 0.5V}{V_{IN} - 2V}$$

$$t_{sw} = \text{Overlap Time} = 50ns + (3ns/A) I_{OUT}$$

5A/2A Step-Down, PWM, Switch-Mode DC-DC Regulators

where t_{SW} is "overlap" time. Switch dissipation is momentarily high during overlap time because both current and voltage appear across the switch at the same time. t_{SW} is approximately: $[50ns + (3ns/A)(I_{OUT})]$ for the MAX724.

Power dissipation in the MAX726 can be estimated in exactly the same way as the MAX724, except that 1.1V (and not 1.8V) is a more reasonable value for the nominal voltage drop across the on-board power switch.

Extra care should be taken in applying the MAX726 in the 16-pin SO package. This package is so small that junction temperatures on the chip in excess of $T_j = +150^\circ C$ can easily be reached unless:

- 1) The leads of the package are soldered directly to a copper printed circuit board.
- 2) A generous ground plane is used; heat transfer largely occurs through the GND pin.

The above precautions will help to maximize the conduction of heat away from the MAX726, and out onto the circuit board.

Ground Connections

GND demands a short low-noise connection to ensure good load regulation. Since the internal reference is referred to GND, errors in the GND pin voltage get multiplied by the error amplifier and appear at the output. If the MAX724/MAX726 GND pin is separated from the negative side of the load, then high load return current can generate significant error across a seemingly small ground resistance. Single-point grounding is the most effective way to eliminate these errors. A recommended ground arrangement is shown in Figure 4.

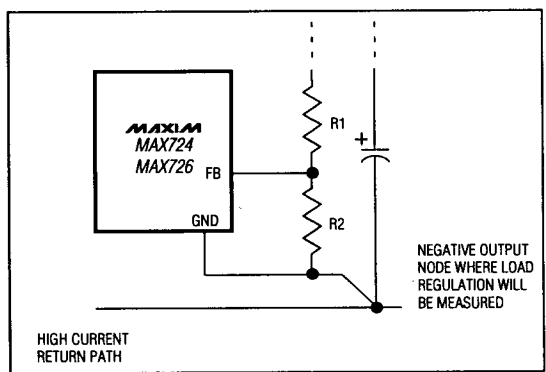

Figure 4. Recommended Ground Connection

Overload Protection

The V_{SW} current is internally limited to about 6.5A in the MAX724 and 2.6A in the MAX726. In addition, another feature of the MAX724/MAX726's overload protection scheme is that the oscillator frequency is reduced when the output voltage falls below approximately half its regulated value. This is the case during short-circuit and heavy overload conditions.

Since the minimum on-time for the switch is about 0.6 μs , frequency reduction during overload ensures that switch duty cycle can fall to a low enough value to maintain control of output current. At the normal 100kHz switching frequency, an on-time as short as 0.2 μs would be needed to provide a narrow enough duty cycle that could control current when the output is shorted. Since 0.6 μs is too long (at 100kHz), the f_{OSC} is lowered to 20kHz once FB (and hence the output) drops below about 1.3V (see Frequency vs. V_{FB} Voltage graph in the *Typical Operating Characteristics*). This way, the MAX724/MAX726's 0.6 μs minimum t_{ON} allows a sufficiently small duty cycle (at the reduced f_{OSC}) so that current can still be limited.

Compensation Network

A series RC network connected from V_C to ground compensates the MAX724/MAX726. Compensation R_C values are shown in the applications circuits. R_C and C_C shape error-amplifier gain as follows: At DC, R_C and C_C have no effect, so the error-amplifier's gain is the product of its transconductance (approximately 5000 $\mu mhos$) and an internal 400k Ω load impedance (r_{INT}) at V_C . So at DC, $A_{V(DC)} = g_M(r_{INT}) =$ approximately 2000 $\mu mhos$. R_C and C_C then add a low-frequency pole and a high-frequency zero, as shown in Figure 5.

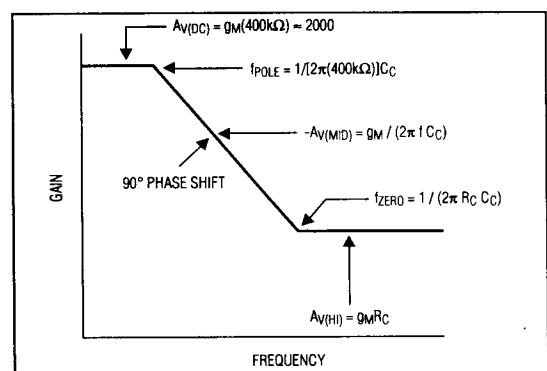

Figure 5. Error-Amplifier Gain as Set by R_C and C_C at V_C Pin

5A/2A Step-Down, PWM, Switch-Mode DC-DC Regulators

Output Overshoot

The MAX724/MAX726 error-amplifier design minimizes overshoot, but precautions against overshoot should still be exercised in sensitive applications. Worst-case overshoot typically occurs when recovering from an output short because V_C slews down from its highest voltage. This can be checked by simply shorting and releasing the output.

Reduce objectional overshoot by increasing the compensation resistor (to $3k\Omega$ or $4k\Omega$) at V_C . This allows the error-amplifier output, V_C , to move more rapidly in the negative direction. In some cases, loop stability may suffer with a high-value compensation resistor. An option, then, is to add output filter capacitance, which reduces short-circuit recovery overshoot by limiting output rise time. Lowering the compensation capacitor to below $0.05\mu\text{F}$ may also help by allowing V_C to slew further before the output rises too far.

Optional Output Filters

Though not shown in the application circuits in Figures 2, 9, and 10, additional filtering can easily be added to reduce output ripple to levels below 2%. It is more effective to add an LC type filter rather than additional output capacitance alone. A small-value inductor ($2\mu\text{H}$ to $10\mu\text{H}$) and between $47\mu\text{F}$ and $220\mu\text{F}$ of filter capacitance should suffice (Figure 6). Although the inductor does not need to be of high quality (it is not switching), it must still be rated for the full load current.

When an LC filter is added, do not move the connection of the feedback resistor to the LC output. It should be left connected to the main output filter capacitor (C_1 in Figure 2). If the feedback connection is moved to the LC filter point, the added phase shift may impact stability.

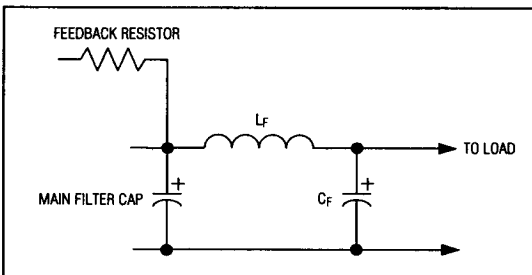

Figure 6. Optional LC Output Filter

Shutdown

There are two shutdown modes in the MAX724/MAX726. One mode forces the switch duty cycle to zero; the other mode forces the entire circuit, including reference, into complete micropower shutdown.

To force the duty cycle to zero and hold the switch in a continuous off state, pull the V_C pin to GND.

Additionally, both shutdown modes can be accessed by the SHUT pin, available with the 7-pin and 16-pin package only. For V_{SHUT} above the 2.45V threshold, the circuit is fully operational. For V_{SHUT} below 2.45V, the switch is held in the zero duty-cycle state. For V_{SHUT} below 0.3V, the device is in full micropower shutdown.

Refer to the SHUT pin voltage and current characteristics (*Typical Operating Characteristics*) to determine how the SHUT pin sources current through its input voltage range. Its $10\mu\text{A}$ source current provides two functions: 1) It pulls up the SHUT pin into the active mode when left open; 2) It acts as a pull-up current for delayed start applications with a capacitor on the SHUT pin.

Figure 7 shows how the SHUT pin can be used to provide undervoltage lockout using just two resistors. The SHUT pin threshold is 2.45V.

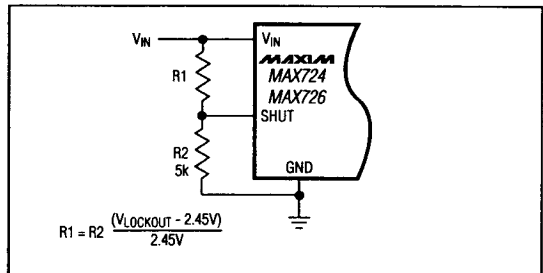

Figure 7. Undervoltage Lockout Application

Adjustable Current Limiting

The I_{LIM} pin on the 7-pin and 16-pin devices can be used to adjust the current limit down from its pre-set level. Attach a resistor R_{LIM} from I_{LIM} to GND. The formula is:

For the MAX724:

$$R_{\text{LIM}} = \left(\frac{I_{\text{LIM}}}{1\text{A}} - 2k\Omega \right) + 1k\Omega$$

5A/2A Step-Down, PWM, Switch-Mode DC-DC Regulators

For the MAX726:

$$R_{LIM} = \left(\frac{I_{LIM}}{1A} \cdot 5.5k\Omega \right) + 1k\Omega$$

For example, a 2.5A current limit requires a 6k Ω R_{LIM} resistor for the MAX724. The accuracy of these formulas is $\pm 25\%$, so set I_{LIM} at least 25% higher than the required peak switch current.

Typical Applications

Positive-to-Negative DC-DC Inverter

The MAX724/MAX726 can convert positive input voltages to negative outputs if the sum of input and output voltage is greater than 8V, and the minimum positive supply is 4.75V. The connection in Figure 8 shows the MAX724 generating -5V. The device's GND pin is connected to the negative output, which allows the feedback divider, R3, and R4 to be connected normally. If the GND pin were tied to circuit ground, a level shift and inversion would be required to generate the proper feedback signal.

Component values in Figure 8 are shown for input voltages up to 40V and for a 1A output. If the maximum input voltage is lower, a Schottky diode with lower reverse breakdown than the MBR745 (D1) may be used. If lower output current is needed, then the current rating of both D1 and L1 may be reduced. In addition, if the minimum input voltage is higher than 4.5V, then greater output current can be supplied.

R1, R2 and C4 provide compensation for low input voltages, but R1 and R2 also figure in the output-voltage calculation because they are effectively connected in parallel with R3. For larger negative outputs, increase R1, R2, and R3 proportionally while maintaining the following relationships. If V_{IN} does not fall below $2V_{OUT}$, then R1, R2, and C4 can be omitted and only R3 and R4 set the output voltage.

$$\begin{aligned} R4 &= 1.82k\Omega \\ R3 &= 1V_{OUT} - 2.37 \text{ (in } k\Omega) \\ R1 &= 1.86 (R3) \\ R\Omega &= 3.65 (R3) \end{aligned}$$

Negative Boost DC-DC Converter

The MAX724/MAX726 can also work as a negative boost converter (Figure 9) by tying the GND pin to the negative output. This allows the regulator to operate from input voltages as low as -4.75V. If the regulated output is at least -8V, R1 and R2 set the output voltage as in a conventional connection, with R1 selected from:

$$R1 = \frac{V_{OUT} R2}{2.21} - R2$$

L1 must be a low value to maintain stability, but if V_{IN} is greater than -10V, L1 can be increased to 50 μ H. Since this is a boost configuration, if the input voltage exceeds the output voltage, D1 will pull the output more negative and out of regulation. Also, if the output is pulled toward ground, D1 will drag down the input supply. For this reason, this configuration is not short-circuit protected.

5A/2A Step-Down, PWM, Switch-Mode DC-DC Regulators

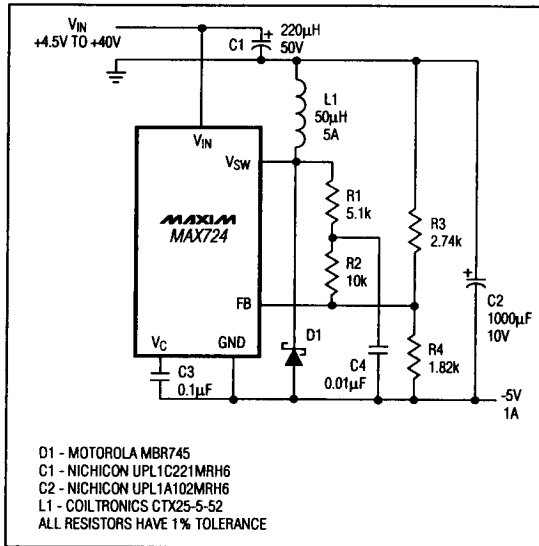

Figure 8. Positive-to-Negative DC-DC Inverter

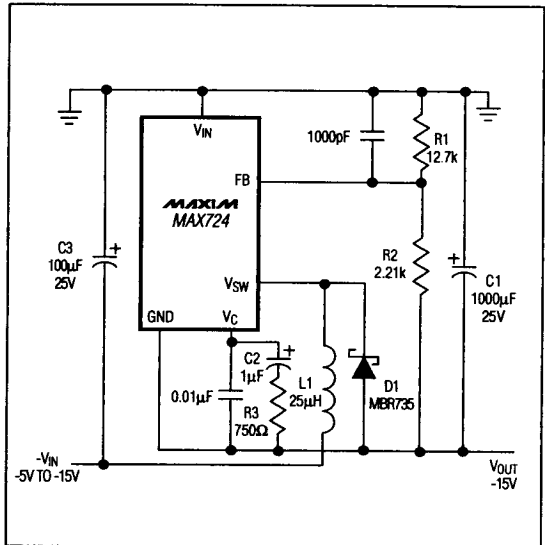
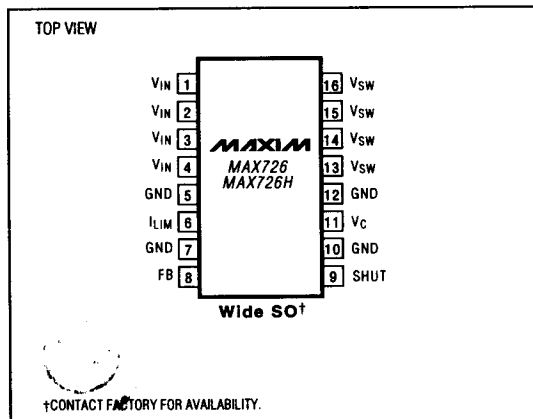
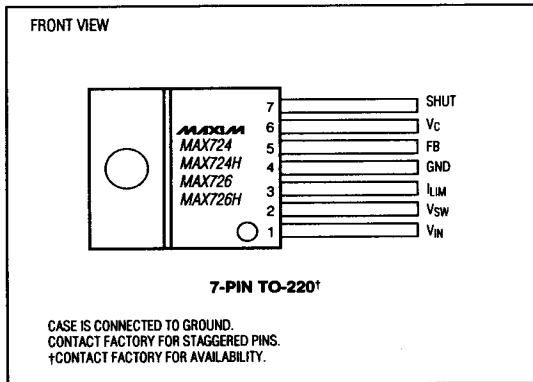
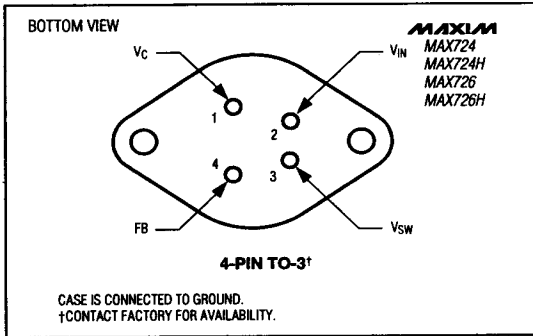

Figure 9. Negative Step-Up DC-DC Converter

5A/2A Step-Down, PWM, Switch-Mode DC-DC Regulators

Pin Configurations (continued)



Ordering Information (continued)

PART	TEMP. RANGE	PIN-PACKAGE
MAX724H CCK	0°C to +70°C	5 TO-220
MAX724HCCM	0°C to +70°C	7 TO-220†
MAX724HCKS	0°C to +70°C	4 TO-3†
MAX724HECK	-40°C to +85°C	5 TO-220
MAX724HECM	-40°C to +85°C	7 TO-220†
MAX724HEKS	-40°C to +85°C	4 TO-3†
MAX724HMKS	-55°C to +125°C	4 TO-3†
MAX726 CWE	0°C to +70°C	16 Wide SO**
MAX726CCK	0°C to +70°C	5 TO-220
MAX726CCM	0°C to +70°C	7 TO-220†
MAX726CKS	0°C to +70°C	4 TO-3†
MAX726ECK	-40°C to +85°C	5 TO-220
MAX726ECM	-40°C to +85°C	7 TO-220†
MAX726EKS	-40°C to +85°C	4 TO-3†
MAX726MKS	-55°C to +125°C	4 TO-3†
MAX726H CWE	0°C to +70°C	16 Wide SO**
MAX726HCCK	0°C to +70°C	5 TO-220
MAX726HCCM	0°C to +70°C	7 TO-220†
MAX726HCKS	0°C to +70°C	4 TO-3†
MAX726HECK	-40°C to +85°C	5 TO-220
MAX726HECM	-40°C to +85°C	7 TO-220†
MAX726HEKS	-40°C to +85°C	4 TO-3†
MAX726HMKS	-55°C to +125°C	4 TO-3†

* Contact factory for availability and processing to MIL-STD-883.

**Contact factory for availability and applications information.

† Contact factory for package availability.