

## Features

- Attenuation: 0.5 dB Steps to 31.5 dB
- Low DC Power Consumption
- Small Footprint, JEDEC Package
- Integral TTL Driver
- 50 ohm Impedance
- Test Boards are Available
- Tape and Reel Packaging Available
- Lead-Free CSP-1 Package
- 100% Matte Tin Plating over Copper
- Halogen-Free “Green” Mold Compound
- 260°C Reflow Compatible
- RoHS\* Compliant Version of AT90-0107

## Description

M/A-COM's MAATCC0009 is a GaAs FET 6-bit digital attenuator with integral TTL driver. Step size is 0.5 dB providing a 31.5 dB total attenuation range. This device is in an PQFN plastic surface mount package. The MAATCC0009 is ideally suited for use where accuracy, fast speed, very low power consumption and low costs are required.

## Ordering Information

| Part Number   | Package           |
|---------------|-------------------|
| MAATCC0009    | Bulk Packaging    |
| MAATCC0009TR  | 1000 piece reel   |
| MAATCC0009-TB | Sample Test Board |

Note: Reference Application Note M513 for reel size information.

\* Restrictions on Hazardous Substances, European Union Directive 2002/95/EC.

## Schematic with Off-Chip Components

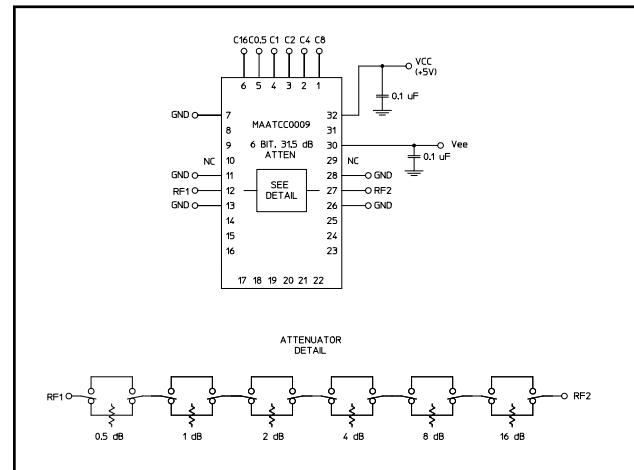

## Pin Configuration<sup>2</sup>

| Pin No. | Function        | Pin No. | Function        |
|---------|-----------------|---------|-----------------|
| 1       | C8              | 17      | NC              |
| 2       | C4              | 18      | NC              |
| 3       | C2              | 19      | NC              |
| 4       | C1              | 20      | NC              |
| 5       | C0.5            | 21      | NC              |
| 6       | C16             | 22      | NC              |
| 7       | GND             | 23      | NC              |
| 8       | NC              | 24      | NC              |
| 9       | NC              | 25      | NC              |
| 10      | NC <sup>1</sup> | 26      | GND             |
| 11      | GND             | 27      | RF2             |
| 12      | RF1             | 28      | GND             |
| 13      | GND             | 29      | NC <sup>1</sup> |
| 14      | NC              | 30      | -Vee            |
| 15      | NC              | 31      | NC              |
| 16      | NC              | 32      | +Vcc            |

1. Pins 10 & 29 must be isolated
2. The exposed pad centered on the package bottom must be connected to RF and DC ground. (For PQFN Packages)

• North America Tel: 800.366.2266 • Europe Tel: +353.21.244.6400  
 • India Tel: +91.80.4155721 • China Tel: +86.21.2407.1588  
 Visit [www.macomtech.com](http://www.macomtech.com) for additional data sheets and product information.

M/A-COM Technology Solutions Inc. and its affiliates reserve the right to make changes to the product(s) or information contained herein without notice.

## Digital Attenuator 31.5 dB, 6-Bit, TTL Driver, DC-4.0 GHz

Rev. V5

**Electrical Specifications:  $T_A = +25^\circ\text{C}$ ,  $V_{ee} = -5\text{ V} \pm 0.25\text{ V}$ ,  $V_{cc} = +5\text{ V} \pm 0.25\text{ V}$**

| Parameter   | Test Conditions  | Frequency                    | Units              | Min        | Typ        | Max  |
|---|--|------------------------------|--------------------|------------|------------|--|
| Insertion Loss  | —  | DC - 4.0 GHz                 | dB                 | —          | 4.5        | 5.1  |
| Attenuation Accuracy  | Individual Bits 0.5-1-2-4-8-16 dB<br>Any Combination of Bits<br>1 to 31.5 dB | DC - 4.0 GHz<br>DC - 4.0 GHz | dB<br>dB           | —<br>—     | —<br>—     | $\pm(.3 + 7\%$ of atten setting)<br>$\pm(.5 + 8\%$ of atten setting) |
| VSWR  | Full Range   | DC - 4.0 GHz                 | Ratio              | —          | 2.0:1      | 2.2:1  |
| Switching Speed   | 50% Cntl to 90%/10% RF<br>10% to 90% or 90% to 10%                           | —<br>—                       | ns<br>ns           | —<br>—     | 75<br>20   | —<br>—   |
| 1 dB Compression  | —<br>—   | 50 MHz<br>0.5 - 4.0 GHz      | dBm<br>dBm         | —<br>—     | +21<br>+24 | —<br>—   |
| Input $IP_3$  | Two-tone inputs up to +5 dBm   | 50 MHz<br>0.5-4.0 GHz        | dBm<br>dBm         | —<br>—     | +35<br>+48 | —<br>—   |
| $V_{IL}$<br>$V_{IH}$  | LOW-level input voltage<br>HIGH-level input voltage                          | —<br>—                       | V<br>V             | 0.0<br>2.0 | —<br>—     | 0.8<br>5.0   |
| $I_{in}$ (Input Leakage Current)                                    | $V_{in} = V_{CC}$ or GND   | —                            | $\mu\text{A}$      | -1.0       | —          | 1.0  |
| $I_{cc}$<br>(Quiescent Supply Current)                              | $V_{cntrl} = V_{CC}$ or GND  | —                            | $\mu\text{A}$      | —          | 250        | 400  |
| $\Delta I_{cc}$<br>(Additional Supply Current<br>Per TTL Input Pin) | $V_{CC} = \text{Max}$ , $V_{cntrl} = V_{CC} - 2.1\text{ V}$                  | —                            | mA                 | —          | —          | 1.0  |
| $I_{EE}$  | $V_{EE}$ min to max, $V_{in} = V_{IL}$ or $V_{IH}$                           | —                            | mA                 | -1.0       | -0.2       | —  |
| Thermal Resistance $\theta_{jc}$                                    | —  | —                            | $^\circ\text{C/W}$ | —          | 15         | —  |

### Absolute Maximum Ratings <sup>3,4</sup>

| Parameter                                     | Absolute Maximum  |
|---|---|
| Max. Input Power<br>0.05 GHz<br>0.5 - 4.0 GHz | +27 dBm<br>+34 dBm                                      |
| $V_{CC}$                                      | $-0.5\text{ V} \leq V_{CC} \leq +7.0\text{ V}$          |
| $V_{EE}$                                      | $-8.5\text{ V} \leq V_{EE} \leq +0.5\text{ V}$          |
| $V_{CC} - V_{EE}$                             | $-0.5\text{ V} \leq V_{CC} - V_{EE} \leq 14.5\text{ V}$ |
| $V_{in}^5$                                    | $-0.5\text{ V} \leq V_{in} \leq V_{CC} + 0.5\text{ V}$  |
| Operating Temperature                         | $-40^\circ\text{C}$ to $+85^\circ\text{C}$              |
| Storage Temperature                           | $-65^\circ\text{C}$ to $+125^\circ\text{C}$             |

- Exceeding any one or combination of these limits may cause permanent damage to this device.
- M/A-COM does not recommend sustained operation near these survivability limits.
- Standard CMOS TTL interface, latch-up will occur if logic signal is applied prior to power supply.

### Recommended PCB Configuration<sup>6</sup>

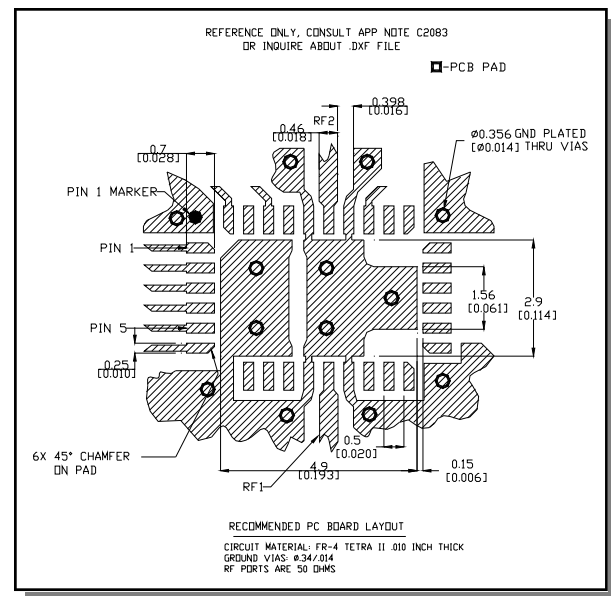

6. Application Note S2083 is available on line at [www.macom.com](http://www.macom.com)

## Handling Procedures

Please observe the following precautions to avoid damage:

### Static Sensitivity

Gallium Arsenide Integrated Circuits are sensitive to electrostatic discharge (ESD) and can be damaged by static electricity. Proper ESD control techniques should be used when handling these devices.

### Moisture Sensitivity

The MSL rating for this part is defined as Level 2 per IPC/JEDEC J-STD-020. Parts shall be stored and/or baked as required for MSL Level 2 parts.

## Truth Table (Digital Attenuator)

| C16 | C8 | C4 | C2 | C1 | C0.5 | Attenuation     |
|-----|----|----|----|----|------|-----------------|
| 0   | 0  | 0  | 0  | 0  | 0    | Loss, Reference |
| 0   | 0  | 0  | 0  | 0  | 1    | 0.5 dB          |
| 0   | 0  | 0  | 0  | 1  | 0    | 1.0 dB          |
| 0   | 0  | 0  | 1  | 0  | 0    | 2.0 dB          |
| 0   | 0  | 1  | 0  | 0  | 0    | 4.0 dB          |
| 0   | 1  | 0  | 0  | 0  | 0    | 8.0 dB          |
| 1   | 0  | 0  | 0  | 0  | 0    | 16.0 dB         |
| 1   | 1  | 1  | 1  | 1  | 1    | 31.5 dB         |

0 = TTL Low; 1 = TTL High

## Typical Performance Curves

### Insertion Loss

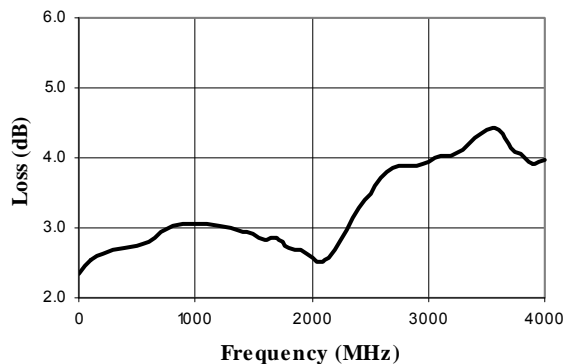

### VSWR @ Insertion Loss

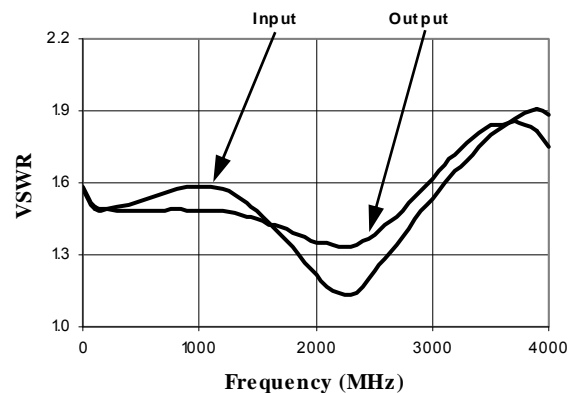

### Attenuation Error, 0.5 dB Bit

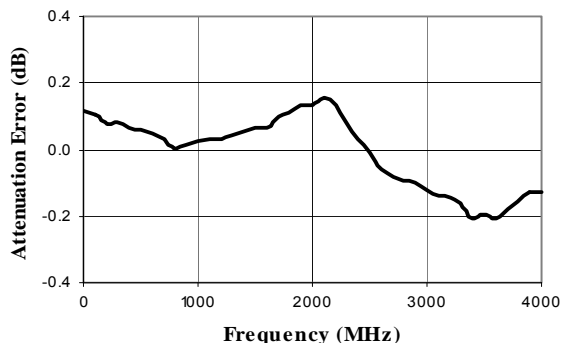

### Attenuation Error, 1 dB Bit

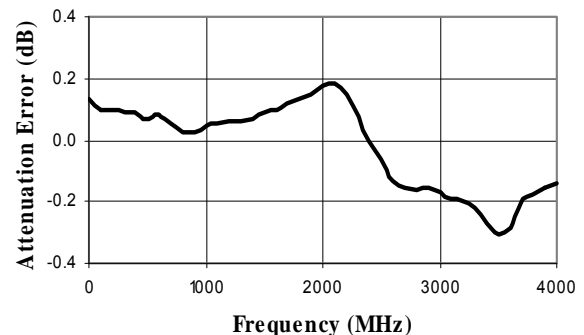

## Typical Performance Curves

Attenuation Error, 2 dB Bit

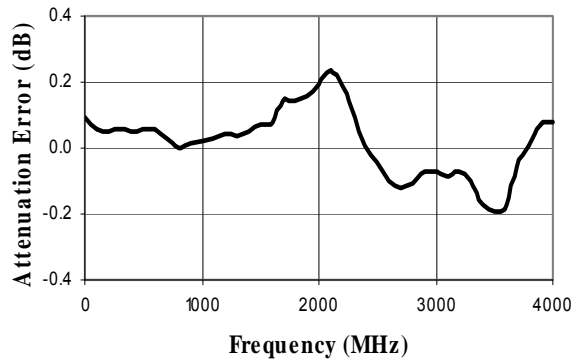

Attenuation Error, 4 dB Bit

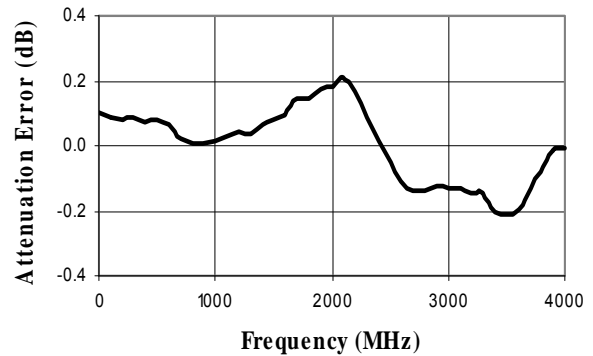

Attenuation Error, 8 dB Bit

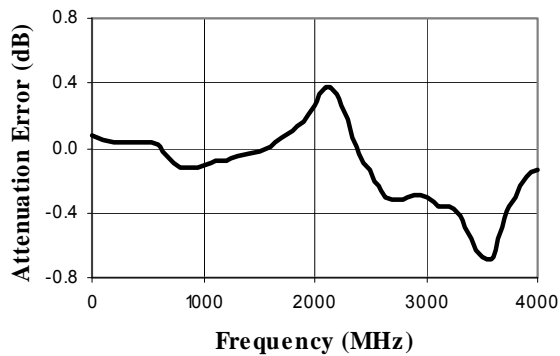

Attenuation Error, 16 dB Bit

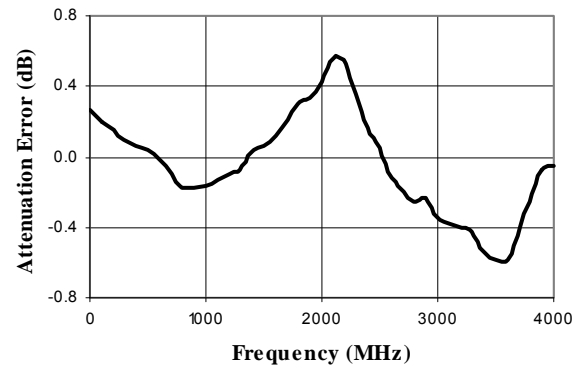

Attenuation Error, Max. Attenuation

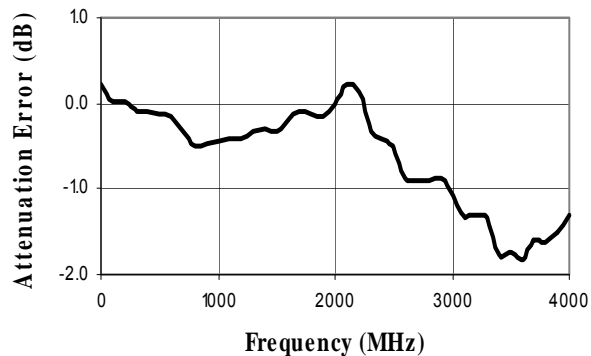

VSWR, 0.5 dB Bit

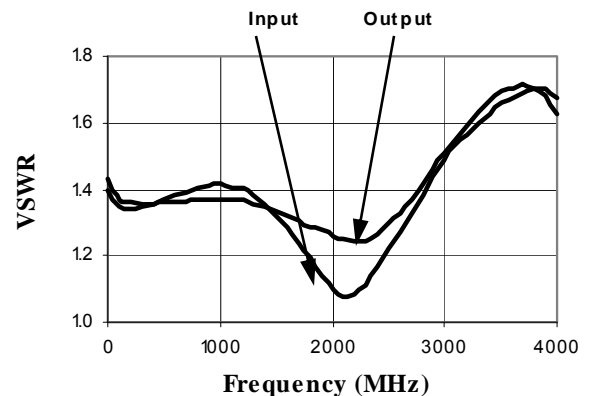

## Typical Performance Curves

VSWR, 1 dB Bit

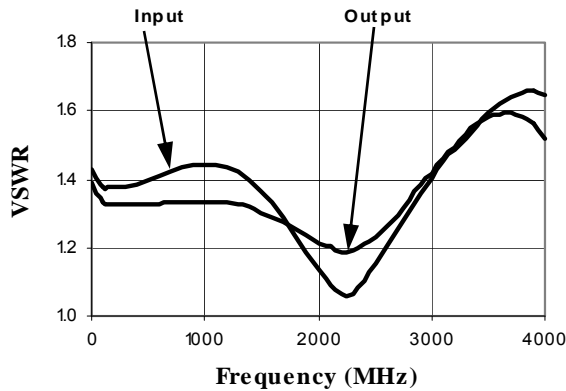

VSWR, 2 dB Bit

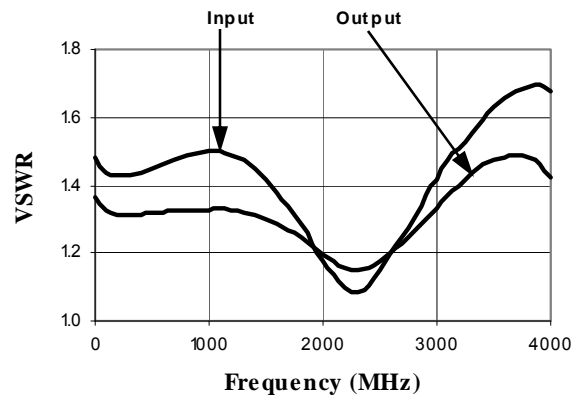

VSWR, 4 dB Bit

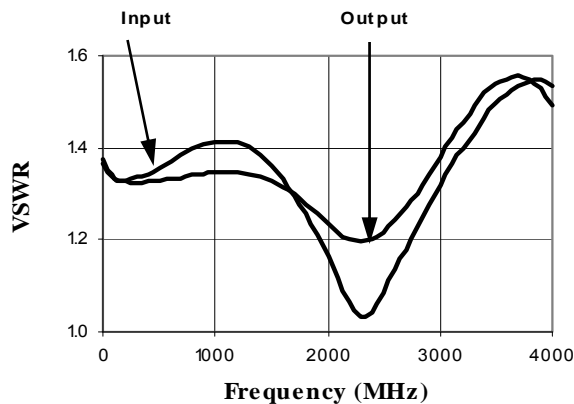

VSWR, 8 dB Bit

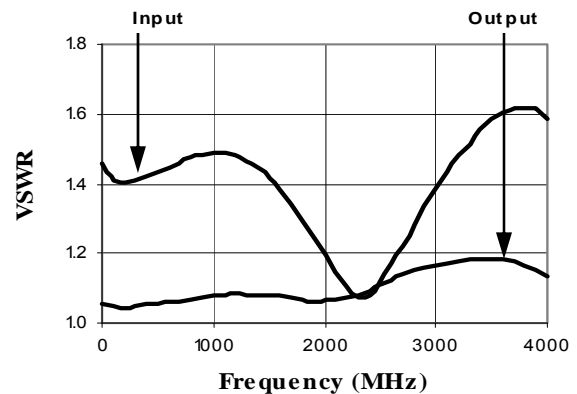

VSWR, 16 dB Bit

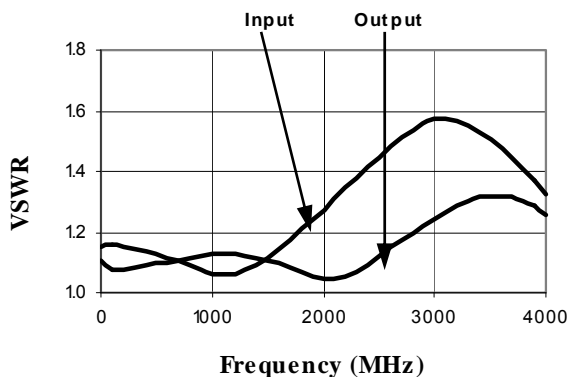

VSWR, Max. Attenuation

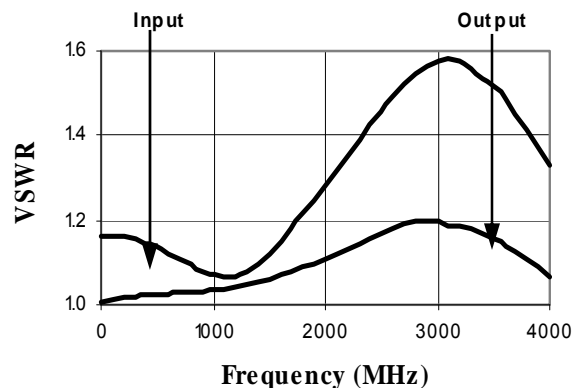

## Typical Performance Curves

**Typical Attenuation Deviation vs. Temperature for 0.5 dB Bit**

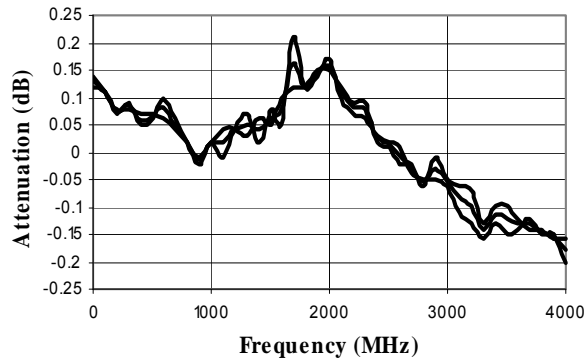

**Typical Attenuation Deviation vs. Temperature for 1 dB Bit**

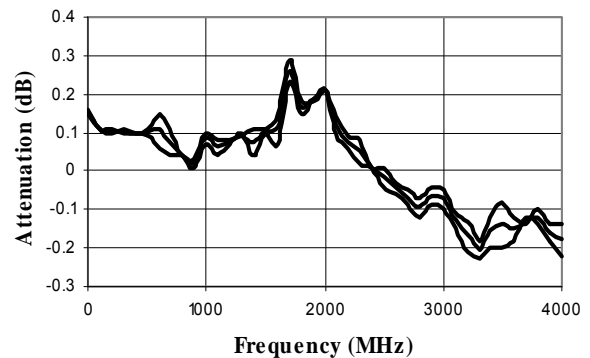

**Typical Attenuation Deviation vs. Temperature for 2 dB Bit**

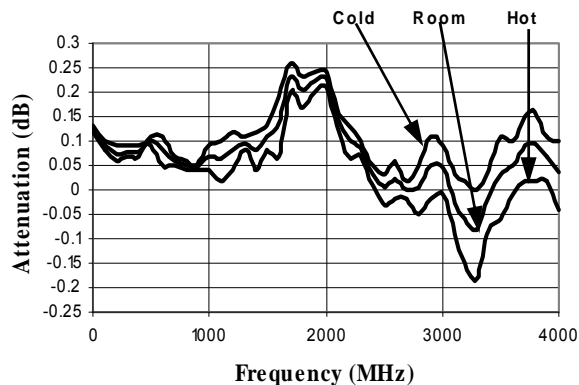

**Typical Attenuation Deviation vs. Temperature for 4 dB Bit**

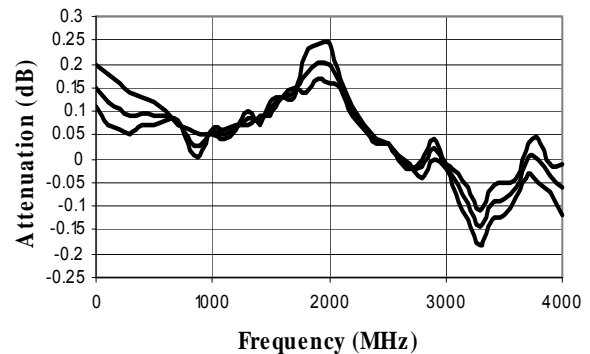

**Typical Attenuation Deviation vs. Temperature for 8 dB Bit**

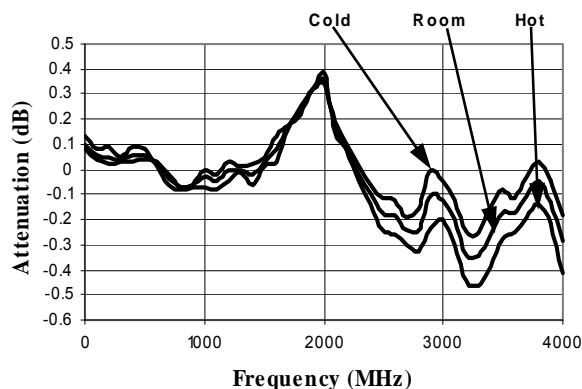

**Typical Attenuation Deviation vs. Temperature for 16 dB Bit**

