

## Features

- Attenuation: 1.0 dB steps to 15 dB
- Low DC Power Consumption
- Integral TTL Driver
- 50 Ohm Impedance
- Temperature Stability:  $\pm 0.18$  dB from  $-40^{\circ}\text{C}$  to  $+85^{\circ}\text{C}$  Typ.
- Lead-Free SO-16 Package
- 100% Matte Tin Plating over Copper
- Halogen-Free “Green” Mold Compound
- $260^{\circ}\text{C}$  Reflow Compatible
- RoHS\* Compliant Version of AT65-0413

## Description

M/A-COM’s MAATCC0008 is a GaAs FET 4-bit digital attenuator with a 1.0 dB minimum step size and a 15 dB total attenuation range. This device is in a SOIC-16 plastic surface mount package. The MAATCC0008 is ideally suited for use where accuracy, fast speed, very low power consumption and low costs are required. Typical applications include dynamic range setting in precision receiver circuits and other gain/leveling control circuits.

## Ordering Information

Part Number	Package
MAATCC0008	Bulk Packaging
MAATCC0008TR	1000 piece reel
MAATCC0008-TB	Sample Test Board

Note: Reference Application Note M513 for reel size information.

## Schematic with Off-Chip Components or Functional Block

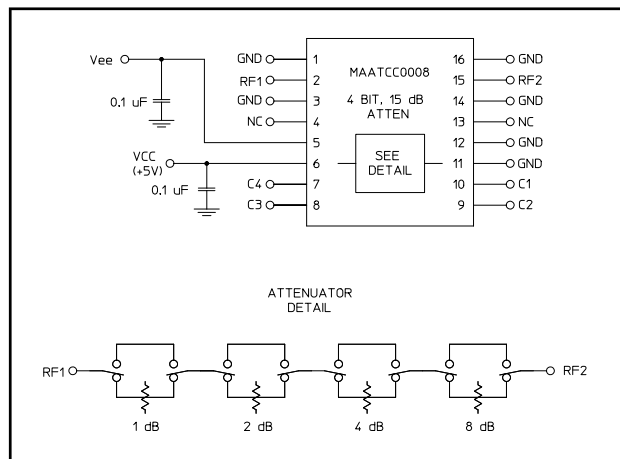

## Pin Configuration

Pin No.	Function	Pin No.	Function
1	GND	9	C2
2	RF1	10	C1
3	GND	11	GND
4	NC <sup>1</sup>	12	GND
5	Vee	13	NC <sup>1</sup>
6	Vcc	14	GND
7	C4	15	RF2
8	C3	16	GND

1. NC = No Connection

\* Restrictions on Hazardous Substances, European Union Directive 2002/95/EC.

Digital Attenuator  
15.0 dB, 4-Bit, TTL Driver, DC-3.0 GHz

M/A-COM Products  
Rev. 5

## Electrical Specifications: $T_A = 25^\circ\text{C}$

Parameter	Test Conditions	Frequency	Units	Min	Typ	Max
Insertion Loss	—	DC - 0.5 GHz	dB	—	1.5	1.9
		DC - 2.0 GHz	dB	—	1.8	2.2
		DC - 3.0 GHz	dB	—	2.1	2.6
Attenuation Accuracy	Any Bit or Combination of Bits	DC - 3.0 GHz	dB	$\pm (.25 + 3\% \text{ of attenuation})$ or $\pm .55$ dB, Whichever is greater		
VSWR	Full Range	DC - 3.0 GHz	Ratio	—	—	1.6:1
Trise, Tfall Ton, Toff Transients	10% to 90% 50% Cntl to 90%/10% RF In-Band	10% to 90% 50% Cntl to 90%/10% RF In-Band	nS	—	10	50
			nS	—	30	150
			mV	—	35	—
Switching Speed	50% Cntl to 90%/10% RF 10% to 90% or 90% to 10%	—	ns	—	25	—
			ns	—	4	—
1 dB Compression	—	50 MHz 0.5 - 3.0 GHz	dBm	—	+21	—
			dBm	—	+27	—
Input IP3	Two-tone Inputs up to +5 dBm	50 MHz 0.5 - 3.0 GHz	dBm	—	+35	—
			dBm	—	+48	—
Input IP2	Two-tone inputs up to +5 dBm	0.05 GHz 0.5 - 3.0 GHz	dBm	—	+43	—
			dBm	—	+73	—
V <sub>CC</sub> V <sub>EE</sub>	—	—	V	4.5	5.0	5.5
			V	-8.0	-5.0	-4.75
V <sub>IL</sub> V <sub>IH</sub>	LOW-level input voltage HIGH-level input voltage	—	V	0.0	—	0.8
			V	2.0	—	5.0
I <sub>in</sub> (Input Leakage Current)	V <sub>in</sub> = V <sub>CC</sub> or GND	—	uA	-1.0	—	1.0
I <sub>cc</sub> (Quiescent Supply Current)	V <sub>cntrl</sub> = V <sub>CC</sub> or GND	—	uA	—	250	400
$\Delta I_{cc}$ (Additional Supply Current Per TTL Input Pin)	V <sub>CC</sub> = Max, V <sub>cntrl</sub> = V <sub>CC</sub> - 2.1 V	—	mA	—	—	1.0
IEE	V <sub>EE</sub> min to max, V <sub>in</sub> = V <sub>IL</sub> or V <sub>IH</sub>	—	mA	-1.0	-0.2	—

## Absolute Maximum Ratings <sup>2,3</sup>

Parameter	Absolute Maximum
Max. Input Power 0.05 GHz 0.5 - 3.0 GHz	+27 dBm +34 dBm
V <sub>CC</sub>	-0.5V $\leq$ V <sub>CC</sub> $\leq$ +7.0V
V <sub>EE</sub>	-8.5V $\leq$ V <sub>EE</sub> $\leq$ +0.5V
V <sub>CC</sub> - V <sub>EE</sub>	-0.5V $\leq$ V <sub>CC</sub> - V <sub>EE</sub> $\leq$ 14.5V
V <sub>in</sub> <sup>4</sup>	-0.5V $\leq$ V <sub>in</sub> $\leq$ V <sub>CC</sub> + 0.5V
Operating Temperature	-40°C to +85°C
Storage Temperature	-65°C to +125°C

- Exceeding any one or combination of these limits may cause permanent damage to this device.
- M/A-COM does not recommend sustained operation near these survivability limits.
- Standard CMOS TTL interface, latch-up will occur if logic signal is applied prior to power supply.

## Recommended PCB Configuration

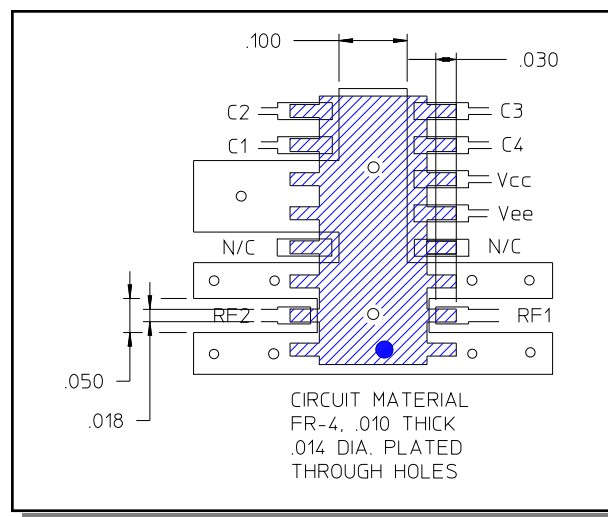

• North America Tel: 800.366.2266 • Europe Tel: +353.21.244.6400  
 • India Tel: +91.80.43537383 • China Tel: +86.21.2407.1588  
 Visit [www.macomtech.com](http://www.macomtech.com) for additional data sheets and product information.

M/A-COM Technology Solutions Inc. and its affiliates reserve the right to make changes to the product(s) or information contained herein without notice.

**ADVANCED:** Data Sheets contain information regarding a product M/A-COM Technology Solutions is considering for development. Performance is based on target specifications, simulated results, and/or prototype measurements. Commitment to develop is not guaranteed.  
**PRELIMINARY:** Data Sheets contain information regarding a product M/A-COM Technology Solutions has under development. Performance is based on engineering tests. Specifications are typical. Mechanical outline has been fixed. Engineering samples and/or test data may be available. Commitment to produce in volume is not guaranteed.

## Handling Procedures

Please observe the following precautions to avoid damage:

## Static Sensitivity

Gallium Arsenide Integrated Circuits are sensitive to electrostatic discharge (ESD) and can be damaged by static electricity. Proper ESD control techniques should be used when handling these devices.

## Typical Performance Curves

### Reference Loss vs. Frequency

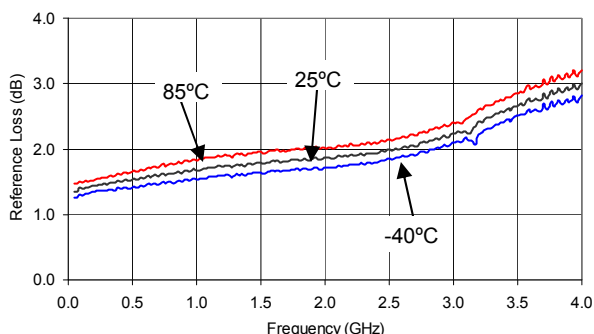

## Truth Table (Digital Attenuator)

C1	C2	C3	C4	Attenuation
0	0	0	0	Loss, Reference
1	0	0	0	1.0 dB
0	1	0	0	2.0 dB
0	0	1	0	4.0 dB
0	0	0	1	8.0 dB
1	1	1	1	15.0 dB

0 = TTL Low; 1 = TTL High

### Attenuation - 1 dB Bit vs. Frequency

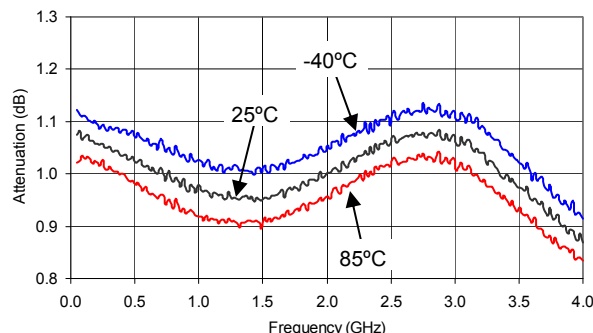

### Attenuation - 2 dB Bit vs. Frequency

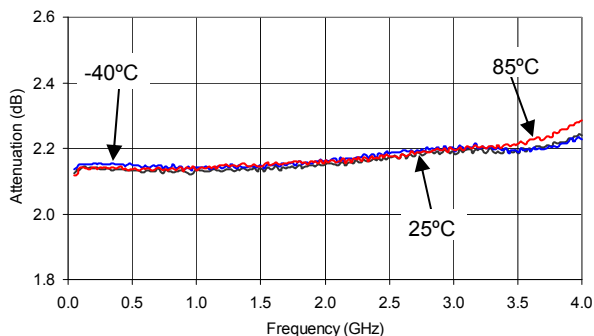

### Attenuation - 4 dB Bit vs. Frequency

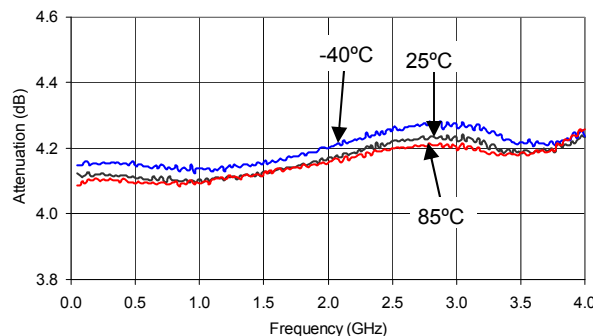

## Typical Performance Curves

### Attenuation - 8 dB Bit vs. Frequency

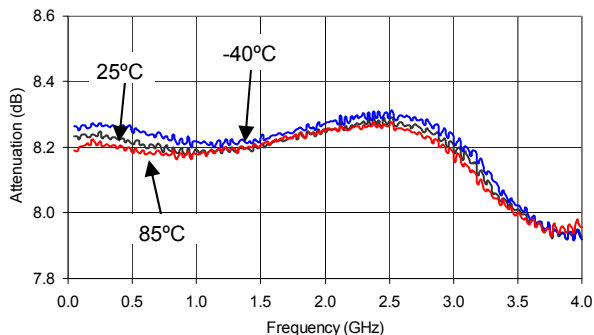

### Attenuation - 15 dB Attenuation vs. Frequency

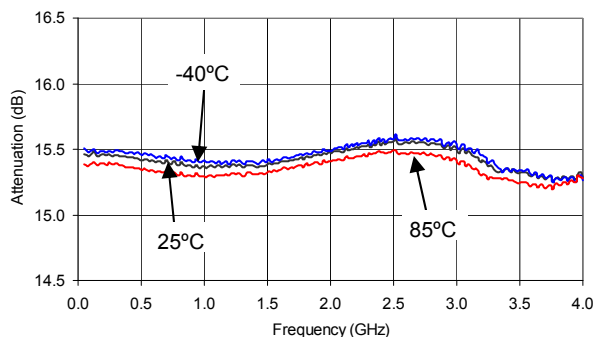

### VSWR vs. Frequency Reference Loss State

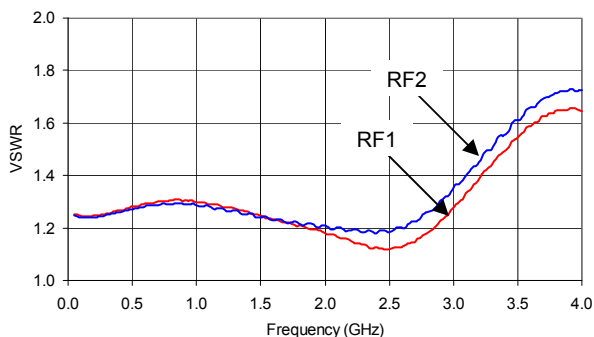

### VSWR - 1 dB Bit vs. Frequency

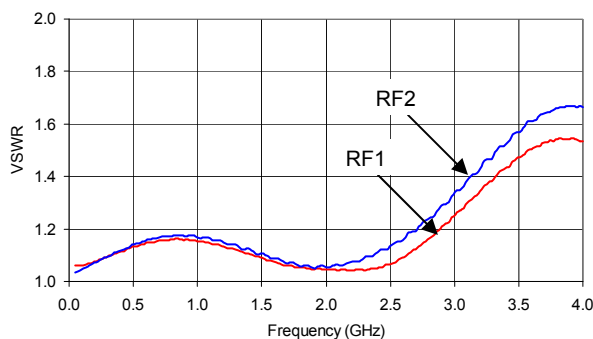

### VSWR - 2 dB Bit vs. Frequency

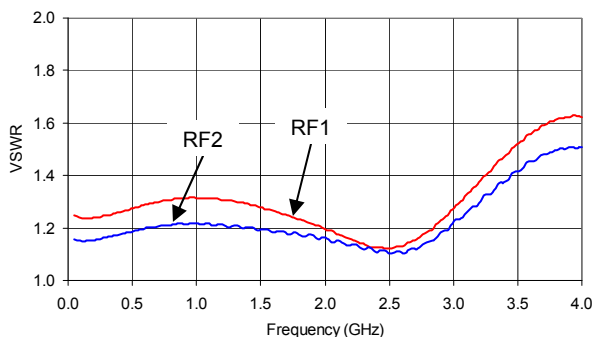

### VSWR - 4 dB Bit vs. Frequency

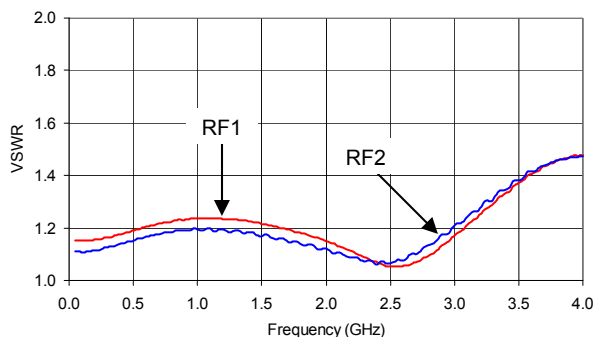

## Typical Performance Curves

VSWR - 8 dB Bit vs. Frequency

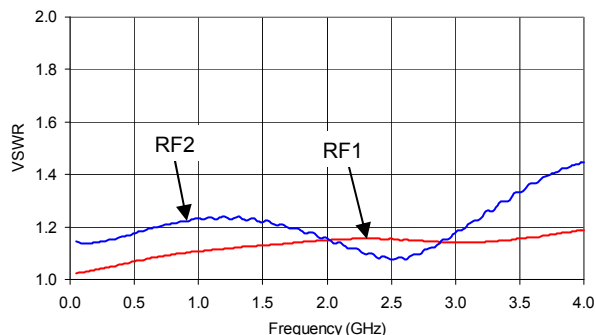

VSWR - 15 dB Attenuation vs. Frequency

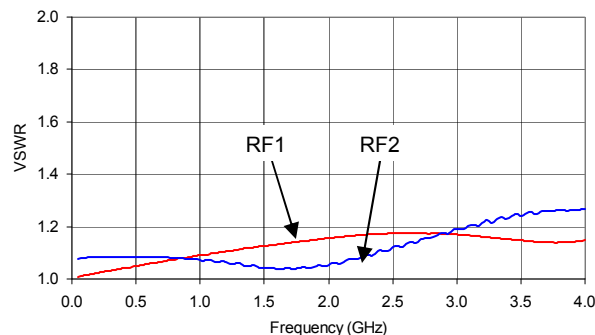

## Lead-Free, SOIC-16<sup>†</sup>

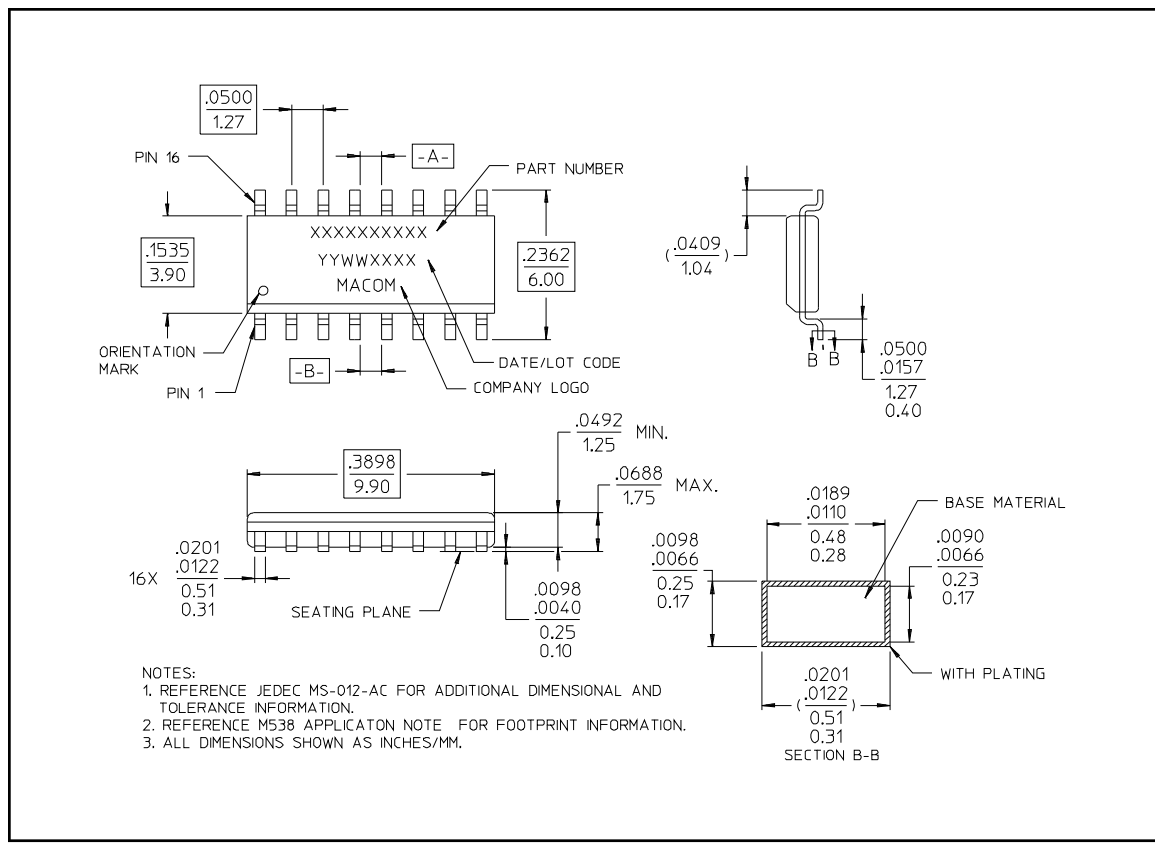

<sup>†</sup> Reference Application Note M538 for lead-free solder reflow recommendations.