



Micro Commercial Components
 21201 Itasca Street Chatsworth
 CA 91311
 Phone: (818) 701-4933
 Fax: (818) 701-4939

ES1A THRU ES1M

Features

- For Surface Mount Applications
- Extremely Low Thermal Resistance
- Easy Pick And Place
- High Temp Soldering: 250°C for 10 Seconds At Terminals
- Superfast Recovery Times For High Efficiency

**1 Amp Super Fast
Recovery
Silicon Rectifier
50 to 1000 Volts**

Maximum Ratings

- Operating Temperature: -50°C to +150°C
- Storage Temperature: -50°C to +150°C
- Maximum Thermal Resistance; 15°C/W Junction To Lead

MCC Catalog Number	Device Marking	Maximum Recurrent Peak Reverse Voltage	Maximum RMS Voltage	Maximum DC Blocking Voltage
ES1A	ES1A	50V	35V	50V
ES1B	ES1B	100V	70V	100V
ES1C	ES1C	150V	105V	150V
ES1D	ES1D	200V	140V	200V
ES1G	ES1G	400V	280V	400V
ES1J	ES1J	600V	420V	600V
ES1K	ES1K	800V	560V	800V
ES1M	ES1M	1000V	700V	1000V

DO-214AC (SMAJ) (High Profile)

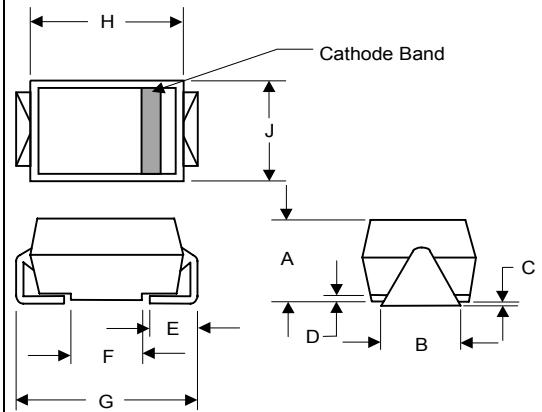

Electrical Characteristics @ 25°C Unless Otherwise Specified

Parameter	Symbol	Value	Conditions
Average Forward Current	$I_{F(AV)}$	1.0A	$T_J = 75^\circ\text{C}$
Peak Forward Surge Current	I_{FSM}	30A	8.3ms, half sine
Maximum Instantaneous Forward Voltage	V_F	.975V 1.35V 1.60V	$I_{FM} = 1.0A$; $T_J = 25^\circ\text{C}^*$
Maximum DC Reverse Current At Rated DC Blocking Voltage	I_R	5 μA 100 μA	$T_J = 25^\circ\text{C}$ $T_J = 100^\circ\text{C}$
Maximum Reverse Recovery Time	T_{rr}	50ns 60ns 100ns	$I_F=0.5A$, $I_R=1.0A$, $I_{rr}=0.25A$
Typical Junction Capacitance	C_J	45pF	Measured at 1.0MHz, $V_R=4.0V$

DIM	INCHES		MM		NOTE
	MIN	MAX	MIN	MAX	
A	.078	.116	1.98	2.95	
B	.067	.089	1.70	2.25	
C	.002	.008	.05	.20	
D	---	.02	---	.51	
E	.035	.055	.89	1.40	
F	.065	.096	1.65	2.45	
G	.205	.224	5.21	5.69	
H	.160	.180	4.06	4.57	
J	.100	.112	2.57	2.84	

SUGGESTED SOLDER PAD LAYOUT

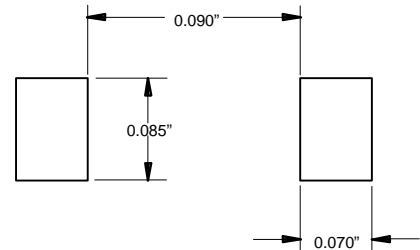

*Pulse test: Pulse width 200 μsec , Duty cycle 2%

Figure 1
Typical Forward Characteristics

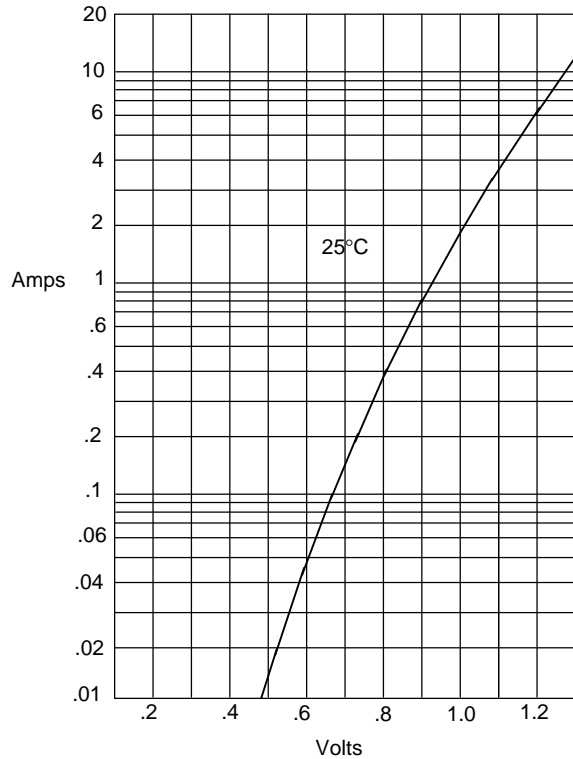

Instantaneous Forward Current - Amperes versus
Instantaneous Forward Voltage - Volts

Figure 2
Forward Derating Curve

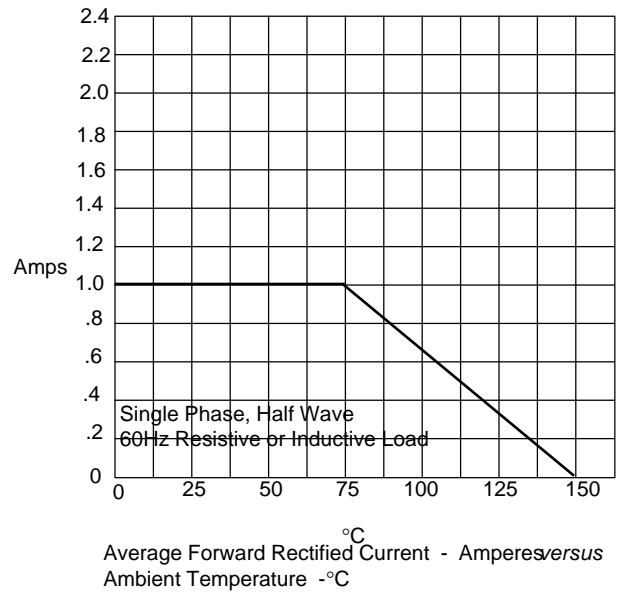

Single Phase, Half Wave
60Hz Resistive or Inductive Load
Average Forward Rectified Current - Amperes versus
Ambient Temperature - °C

Figure 3
Junction Capacitance

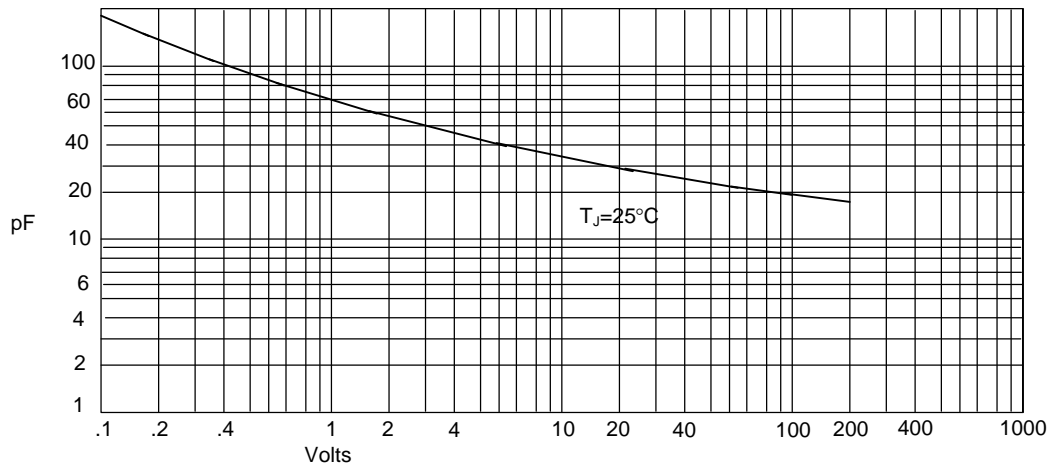

Junction Capacitance - pF versus
Reverse Voltage - Volts

ES1A thru ES1M

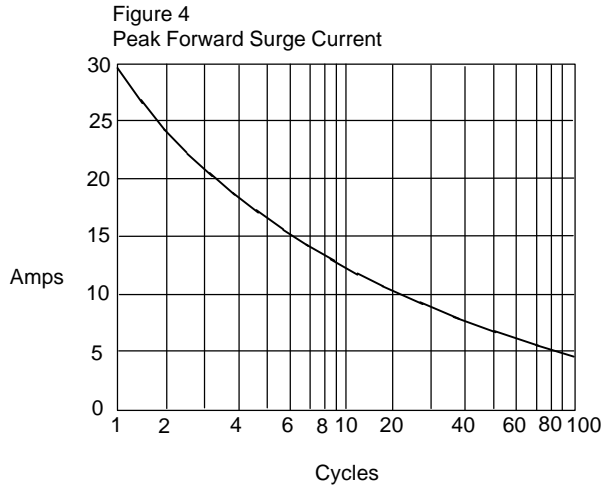

Peak Forward Surge Current - Amperes versus
Number Of Cycles At 60Hz - Cycles

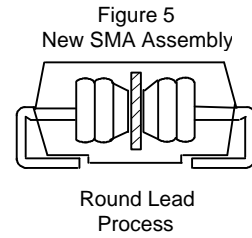
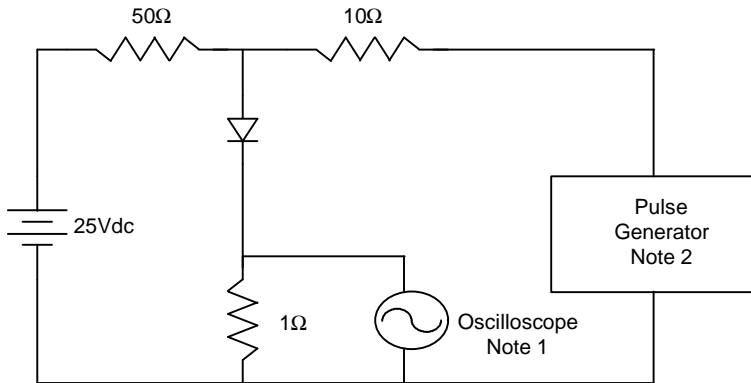

Figure 6
Reverse Recovery Time Characteristic And Test Circuit Diagram



Notes:

1. Rise Time = 7ns max.
Input impedance = 1 megohm, 22pF
2. Rise Time = 10ns max.
Source impedance = 50 ohms
3. Resistors are non-inductive

