



DC COMPONENTS CO., LTD.

RECTIFIER SPECIALISTS

**ES1A
THRU
ES1G**

TECHNICAL SPECIFICATIONS OF SURFACE MOUNT SUPER FAST RECTIFIER

VOLTAGE RANGE - 50 to 400 Volts

CURRENT - 1.0 Ampere

FEATURES

- * Ideal for surface mounted applications
- * Low leakage current
- * Glass passivated junction

MECHANICAL DATA

- * Case: Molded plastic
- * Epoxy: UL 94V-0 rate flame retardant
- * Terminals: Solder plated solderable per MIL-STD-750, Method 2026
- * Polarity: As marked
- * Mounting position: Any
- * Weight: 0.064 gram

MAXIMUM RATINGS AND ELECTRICAL CHARACTERISTICS

Ratings at 25 °C ambient temperature unless otherwise specified.
Single phase, half wave, 60 Hz, resistive or inductive load.
For capacitive load, derate current by 20%.



SMA (DO-214AC)

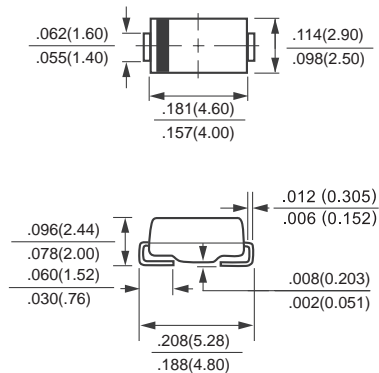

Dimensions in inches and (millimeters)

	SYMBOL	ES1A	ES1B	ES1C	ES1D	ES1E	ES1G	UNITS
Maximum Recurrent Peak Reverse Voltage	V _{RRM}	50	100	150	200	300	400	Volts
Maximum RMS Volts	V _{RMS}	35	70	105	140	210	280	Volts
Maximum DC Blocking Voltage	V _{DC}	50	100	150	200	300	400	Volts
Maximum Average Forward Current at TA = 55°C	I _O	1.0						Amps
Peak Forward Surge Current IFM (surge): 8.3 ms single half sine-wave superimposed on rated load (JEDEC Method)	I _{FSM}	30						Amps
Maximum Forward Voltage at 1.0A DC	V _F	0.95			1.25			Volts
Maximum DC Reverse Current at Rated DC Blocking Voltage	I _R	@ TA = 25°C	5.0				uAmps	
		@ TA = 100°C	100					
Maximum Reverse Recovery Time (Note 1)	t _{rr}	35						nSec
Typical Junction Capacitance (Note 2)	C _J	15			10			pF
Operating and Storage Temperature Range	T _J , T _{STG}	-65 to + 175						°C

NOTES : 1. Test Conditions: I_F=0.5A, I_R=1.0A, I_{RR}=0.25A.
2. Measured at 1 MHz and applied reverse voltage of 4.0 volts.

RATING AND CHARACTERISTIC CURVES (ES1A THRU ES1G)

FIG. 1 - TEST CIRCUIT DIAGRAM AND REVERSE RECOVERY TIME CHARACTERISTIC

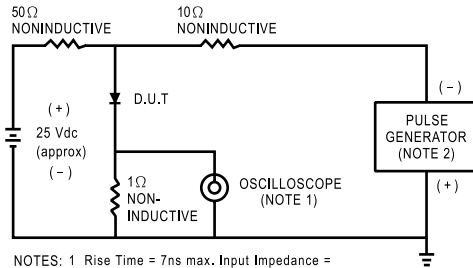

NOTES: 1 Rise Time = 7ns max. Input Impedance = 1 megohm, 22 pF.
2. Rise Time = 10ns max. Source Impedance = 50 ohms.

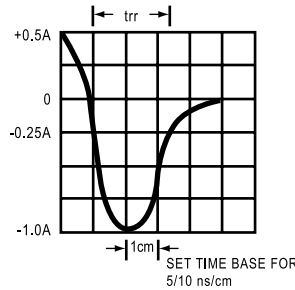

FIG. 2 - TYPICAL FORWARD CURRENT DERATING CURVE

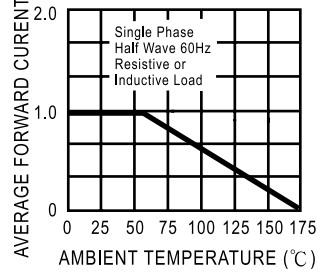

FIG. 3 - TYPICAL REVERSE CHARACTERISTICS

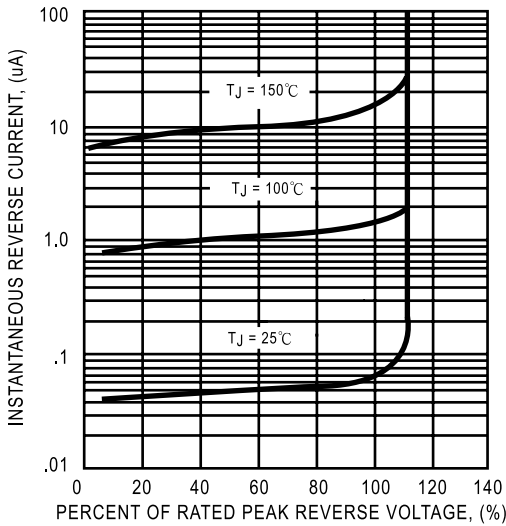

FIG. 4 - TYPICAL INSTANTANEOUS FORWARD CHARACTERISTICS

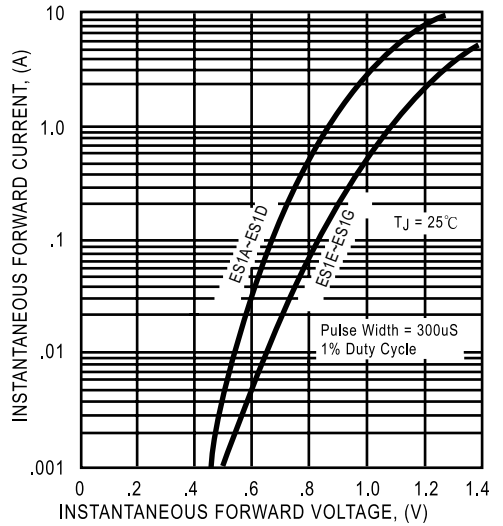

FIG. 5 - MAXIMUM NON-REPETITIVE FORWARD SURGE CURRENT

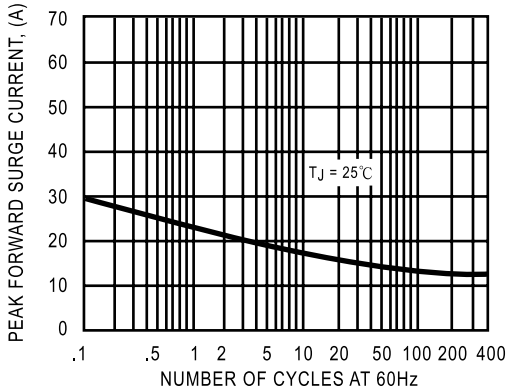
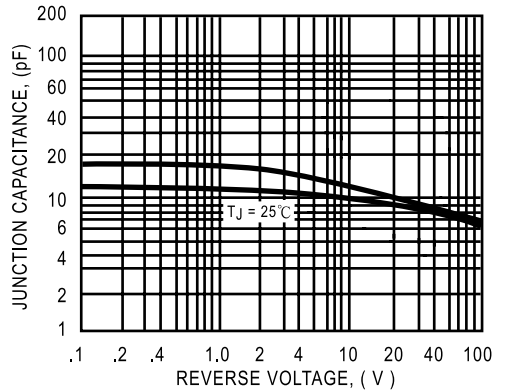

FIG. 6 - TYPICAL JUNCTION CAPACITANCE



DC COMPONENTS CO., LTD.