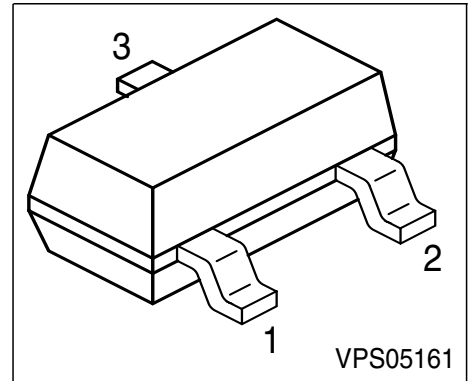
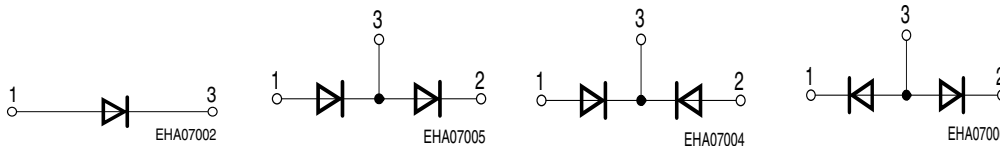

Silicon PIN Diodes

- High voltage current controlled
RF resistor for RF attenuator and switches
- Frequency range above 1 MHz
- Low resistance and short carrier lifetime
- For frequencies up to 3 GHz

BAR 64
BAR 64-04
BAR 64-05
BAR 64-06

Type	Marking	Pin Configuration			Package
BAR 64	POs	1 = A	2 n.c.	3 = C	SOT-23
BAR 64-04	PPs	1 = A1	2 = C2	3=C1/A2	SOT-23
BAR 64-05	PRs	1 = A1	2 = A2	3=C1/C2	SOT-23
BAR 64-06	PSs	1 = C1	2 = C2	3=A1/A2	SOT-23

Maximum Ratings

Parameter	Symbol	Value	Unit
Diode reverse voltage	V_R	200	V
Forward current	I_F	100	mA
Total power dissipation BAR 64, $T_S \leq 90^\circ\text{C}$	P_{tot}	250	mW
BAR 64-04, BAR 64-05, BAR 64-06, $T_S \leq 65^\circ\text{C}$	P_{tot}	250	
Junction temperature	T_j	150	$^\circ\text{C}$
Operating temperature range	T_{op}	-55 ... 150	
Storage temperature	T_{stg}	-55 ... 150	

Thermal Resistance

Junction-ambient 1) BAR 64	R_{thJA}	≤ 320	K/W
Junction-ambient 1) BAR 64-04,05,06	R_{thJA}	≤ 500	
Junction-soldering point BAR 64	R_{thJS}	≤ 240	
Junction-soldering point BAR 64-04,05,06	R_{thJS}	≤ 340	

1) Package mounted on alumina 15mm x 16.7mm x 0.7mm

Electrical Characteristics at $T_A = 25^\circ\text{C}$, unless otherwise specified.

Parameter	Symbol	Values			Unit
		min.	typ.	max.	
DC characteristics					
Breakdown voltage $I_{(BR)} = 5 \mu\text{A}$	$V_{(BR)}$	200	-	-	V
Reverse current $V_R = 80 \text{ V}$	I_R	-	-	50	nA
Forward voltage $I_F = 50 \text{ mA}$	V_F	-	-	1.1	V
AC characteristics					
Diode capacitance $V_R = 20 \text{ V}, f = 1 \text{ MHz}$	C_T	-	0.23	0.35	pF
Forward resistance $I_F = 1 \text{ mA}, f = 100 \text{ MHz}$ $I_F = 10 \text{ mA}, f = 100 \text{ MHz}$ $I_F = 100 \text{ mA}, f = 100 \text{ MHz}$	r_f	-	12.5 2.1 0.85	20 3.8 1.35	Ω
Charge carrier life time $I_F = 10 \text{ mA}, I_R = 6 \text{ mA}, I_R = 3 \text{ mA}$	τ_{rr}	-	1.55	-	μs
Series inductance	L_S	-	1.4	-	nH

Forward current $I_F = f(T_A^*, T_S)$

* mounted on alumina

BAR 64

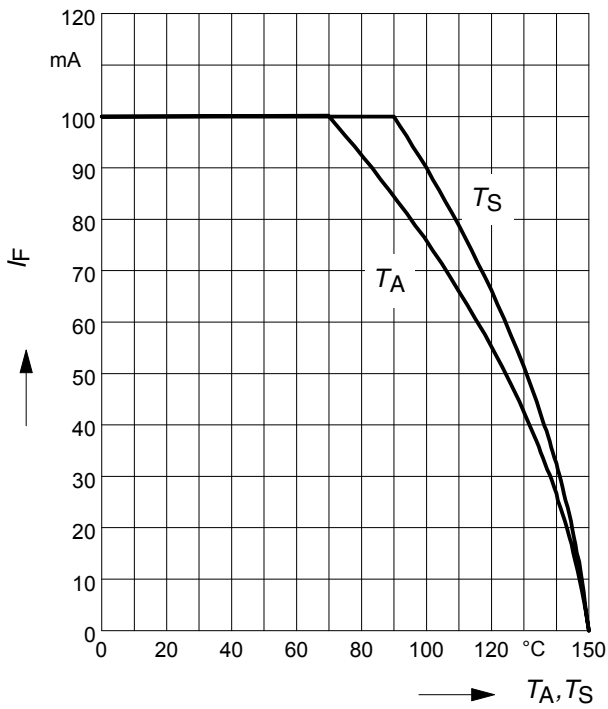

Forward current $I_F = f(T_A^*, T_S)$

* mounted on alumina

BAR 64-04, -05, -06

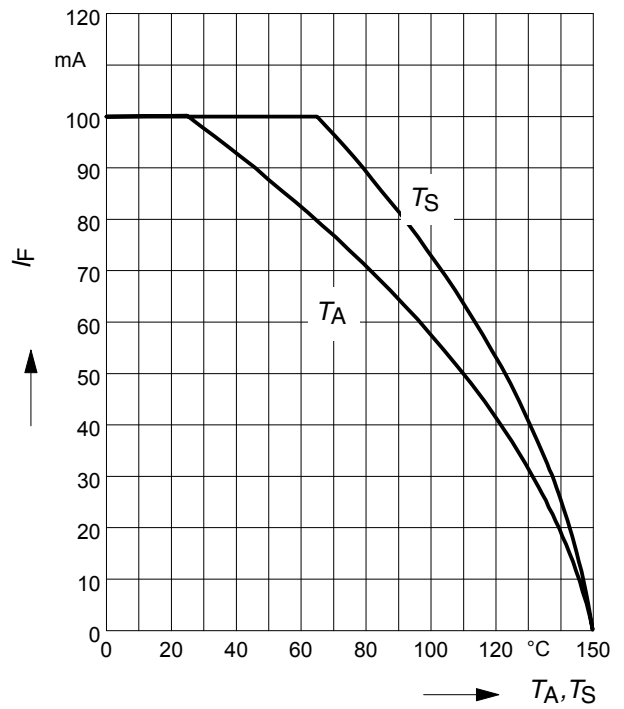

Permissible Pulse Load $R_{thJS} = f(t_p)$

BAR 64

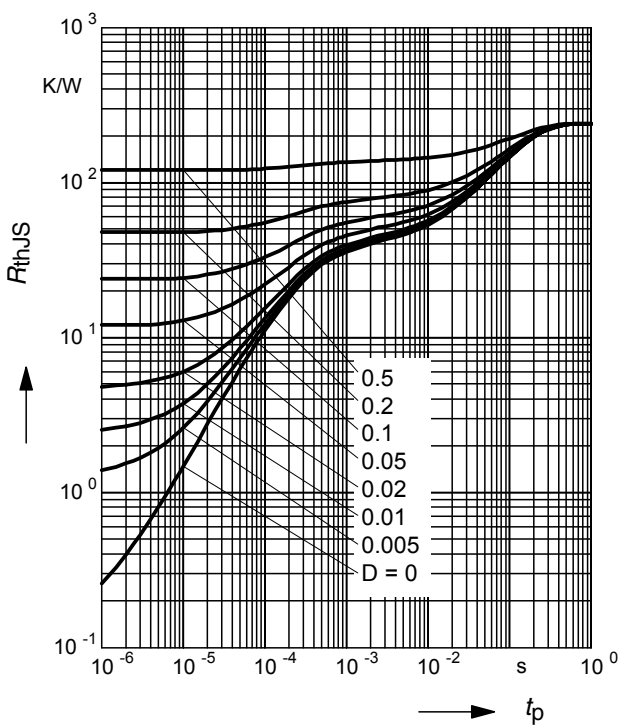

Permissible Pulse Load $I_{Fmax} / I_{FDC} = f(t_p)$

BAR 64

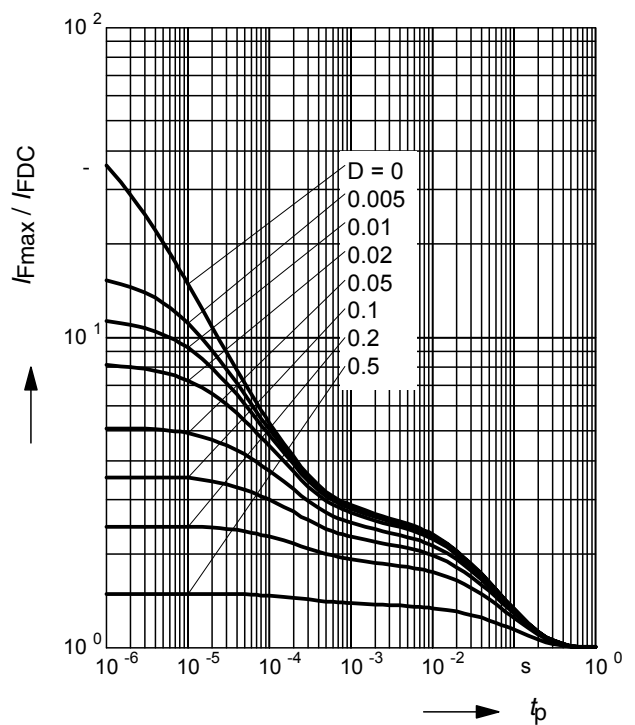

Permissible Pulse Load $R_{thJS} = f(t_p)$

BAR 64-04, -05, -06

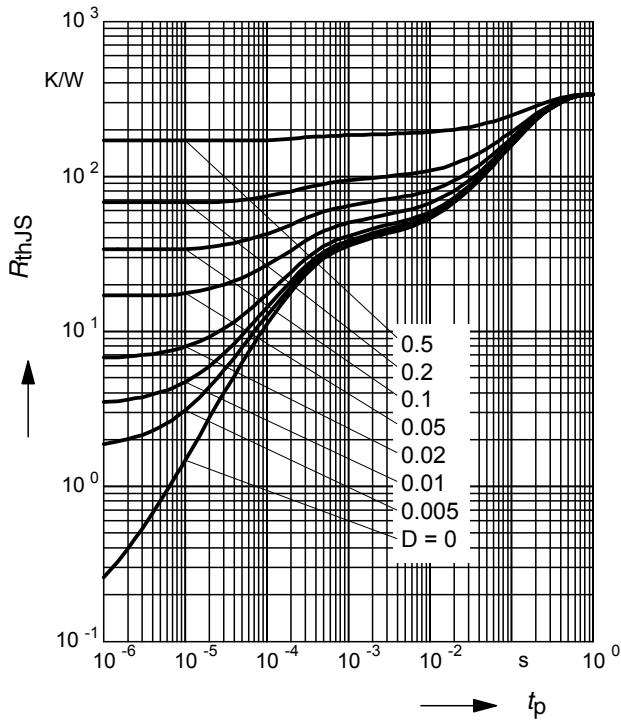

Permissible Pulse Load $I_{Fmax} / I_{FDC} = f(t_p)$

BAR 64-04, -05, -06

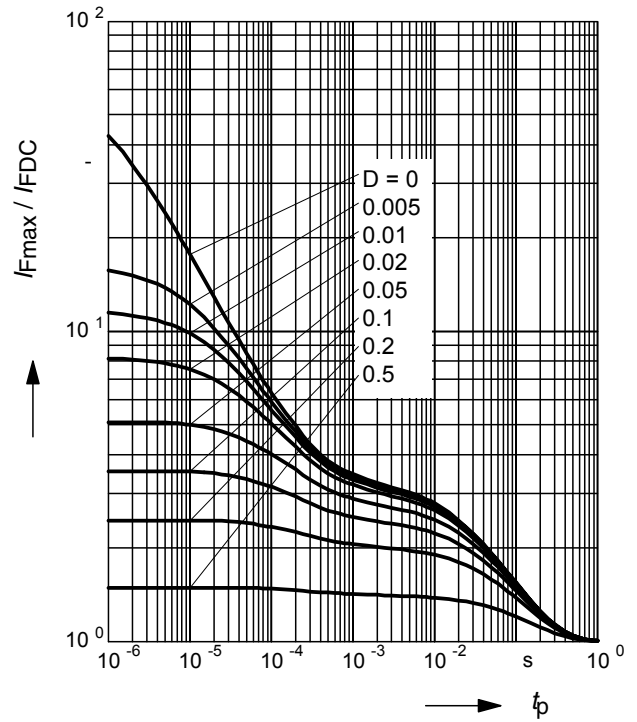

Forward current $I_F = f(V_F)$

$T_A =$ Parameter

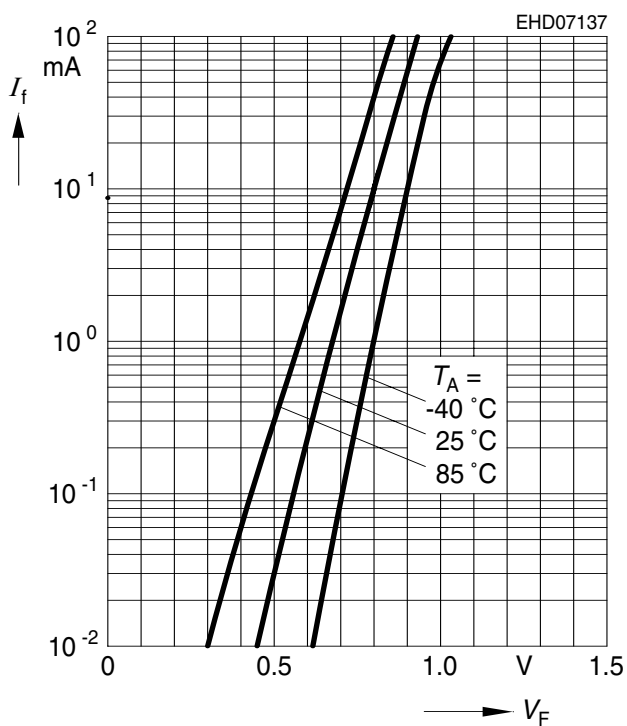

Forward resistance $r_f = f(I_F)$

$f = 100\text{MHz}$

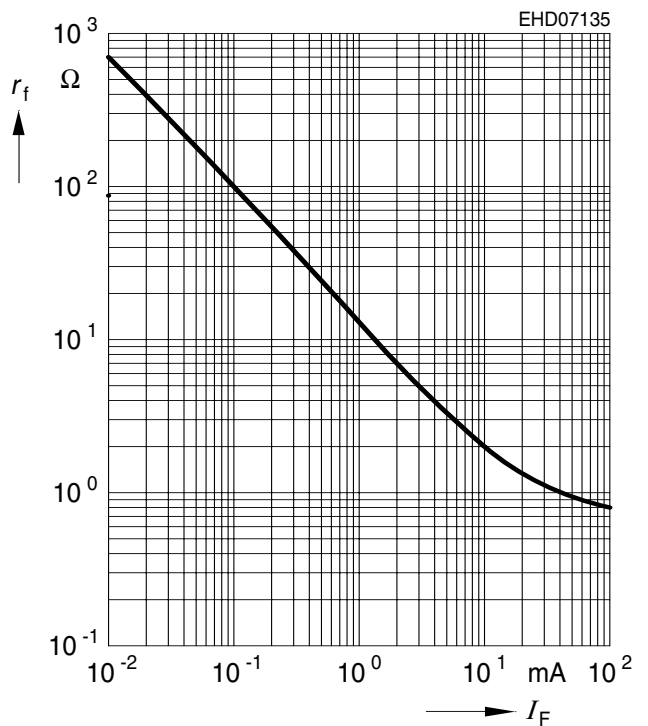

Diode capacitance $C_T = f(V_R)$

$f = 1\text{MHz}$

