

isc Silicon NPN Power Transistor

2SC4758

DESCRIPTION

- High Breakdown Voltage-
: $V_{CBO}= 1500V$ (Min)
- High Switching Speed
- Low Saturation Voltage

APPLICATIONS

- Horizontal deflection output for high resolution display.
- High speed switching power supply output applications

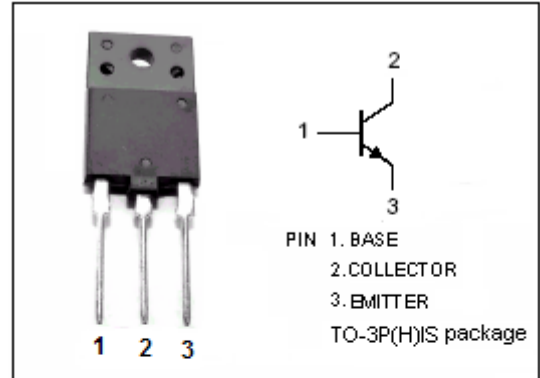

ABSOLUTE MAXIMUM RATINGS($T_a=25^{\circ}C$)

SYMBOL	PARAMETER	VALUE	UNIT
V_{CBO}	Collector-Base Voltage	1500	V
V_{CEO}	Collector-Emitter Voltage	600	V
V_{EBO}	Emitter-Base Voltage	5	V
I_C	Collector Current- Continuous	8	A
I_{CP}	Collector Current-Pulse	16	A
I_B	Base Current- Continuous	4	A
P_C	Collector Power Dissipation @ $T_C=25^{\circ}C$	50	W
T_J	Junction Temperature	150	$^{\circ}C$
T_{stg}	Storage Temperature Range	-55~150	$^{\circ}C$

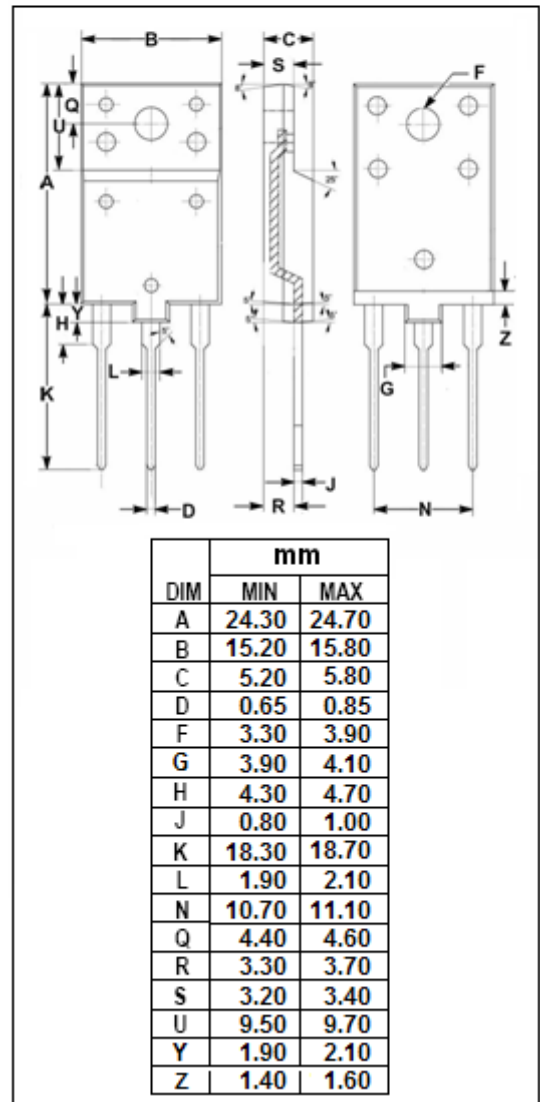

isc Silicon NPN Power Transistor

2SC4758

ELECTRICAL CHARACTERISTICS

 $T_C=25^{\circ}\text{C}$ unless otherwise specified

SYMBOL	PARAMETER	CONDITIONS	MIN	TYP.	MAX	UNIT
$V_{(BR)CEO}$	Collector-Emitter Breakdown Voltage	$I_C=5\text{mA}$; $I_B=0$	600			V
$V_{CE(sat)}$	Collector-Emitter Saturation Voltage	$I_C=6\text{A}$; $I_B=1.5\text{A}$			5.0	V
$V_{BE(sat)}$	Base-Emitter Saturation Voltage	$I_C=6\text{A}$; $I_B=1.5\text{A}$			1.5	V
I_{CBO}	Collector Cutoff Current	$V_{CB}=1500\text{V}$; $I_E=0$			1.0	mA
I_{EBO}	Emitter Cutoff Current	$V_{EB}=5\text{V}$; $I_C=0$			10	μA
h_{FE-1}	DC Current Gain	$I_C=1\text{A}$; $V_{CE}=5\text{V}$	8			
h_{FE-2}	DC Current Gain	$I_C=6\text{A}$; $V_{CE}=5\text{V}$	4		8	
f_T	Current-Gain—Bandwidth Product	$I_C=0.1\text{A}$; $V_{CE}=10\text{V}$	1	3		MHz
C_{OB}	Output Capacitance	$I_E=0$; $V_{CB}=10\text{V}$; $f_{test}=1.0\text{MHz}$		175		pF

Switching times, Resistive load

t_{stg}	Storage Time	$I_C=6\text{A}$, $I_{B1}=1.2\text{A}$; $I_{B2}=-2.4\text{A}$ $R_L=32\ \Omega$			2.5	μs
t_f	Fall Time				0.2	μs

isc Silicon NPN Power Transistor

2SC4758

I_C - V_{CE} Characteristics

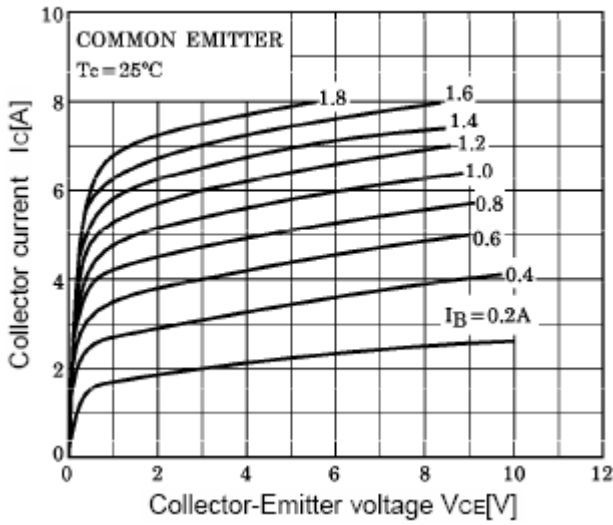

h_{FE} - I_C Characteristics

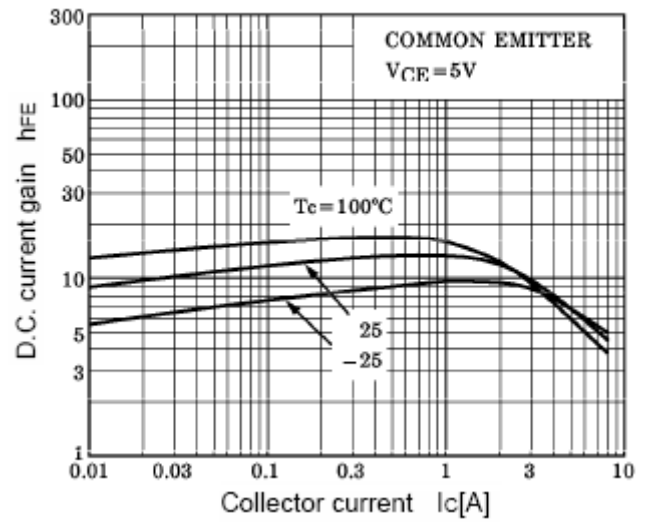

$V_{CE(sat)}$ - I_C Characteristics

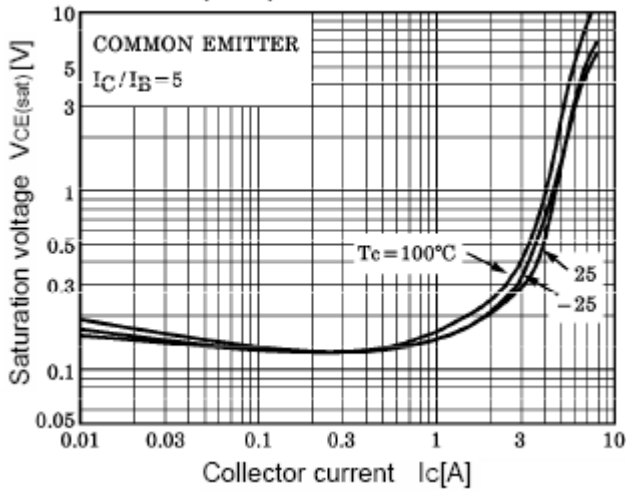

$V_{BE(sat)}$ - I_C Characteristics

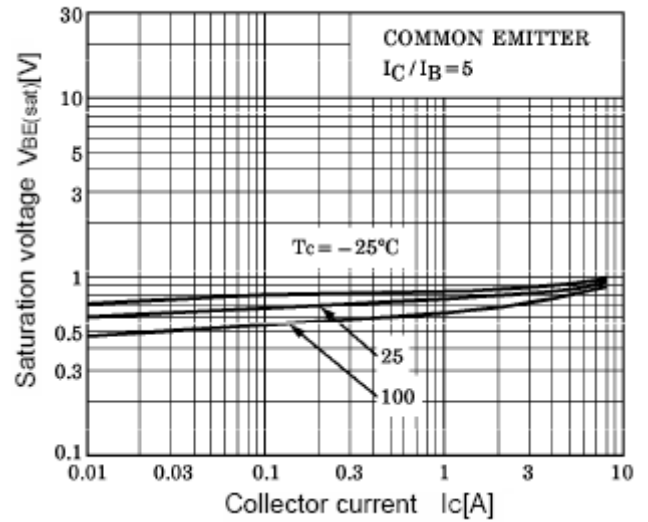

I_C - V_{BE} Characteristics

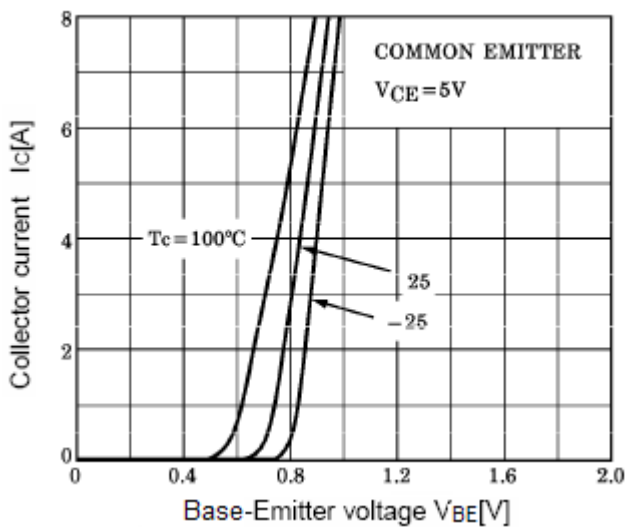

Power Derating

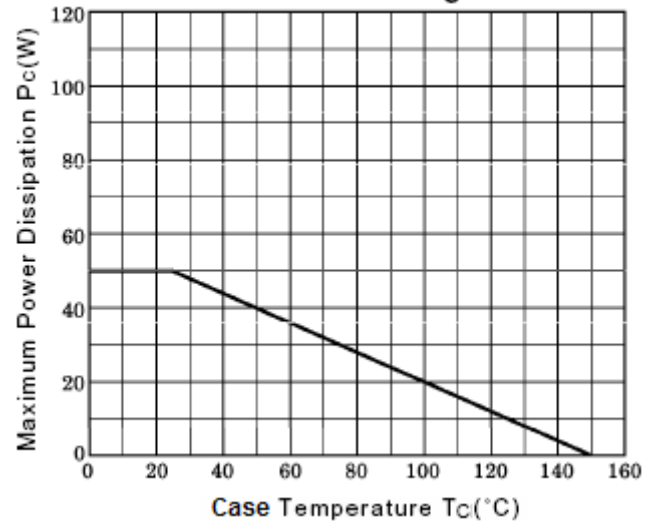

isc Silicon NPN Power Transistor

2SC4758

