



JEWEL HILL ELECTRONIC CO.,LTD.

**SPECIFICATIONS FOR
LCD MODULE**

Module No. GB24064A

Office Address: Rm. 518,5/F., 101 Shangbu Industrial District,
HuaqiangNorthRoad, Shenzhen, China

TEL : (86)-755-83362489 83617492

FAX: (86)-755-83286396 83365871

E-mail: sales@jhlcd.com

jhlcd@21cn.com

Website: www.jhlcd.com

TABLE OF CONTENTS

LCM NUMBER SYSTEM	2
1. GENERAL DESCRIPTION	3
2. FEATURES.....	3
3. MECHANICAL SPECIFICATION	3
4. MECHANICAL DIMENSION	4
5. MAXIMUM RATINGS	5
6. ELECTRICAL CHARACTERISTICS	5
7. MODULE FUNCTION DESCRIPTION	6
8. ELECTRO-OPTICAL CHARACTERISTICS	15
9. RELIABILITY.....	19
10. PRECAUTIONS FOR USING LCD MODULES	20
11. USING LCD MODULES.....	22
12. REVISION HISTORY	24
SAMPLE APPROVED REPORT	25



LCM Number System

GB 240 64 A F W C Y W D A - V02

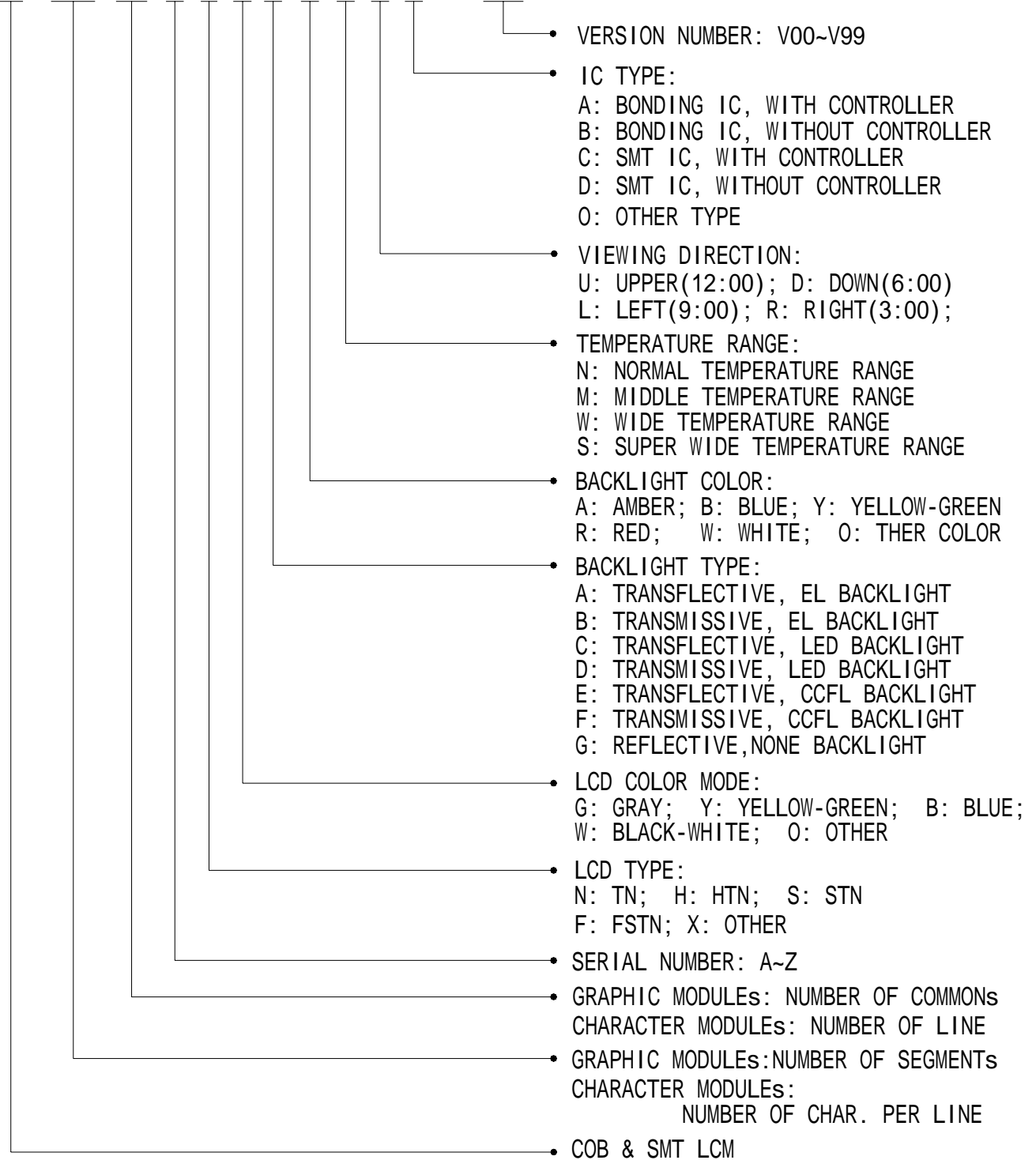

1. GENERAL DESCRIPTION

The GB24064A is a 240 x 64 Dots Graphics LCD module. It has a FSTN panel composed of 240 segments and 64 commons. The LCM can be easily accessed by micro-controller via parallel interface.

2. FEATURES

Display Mode	Transflective and positive
	FSTN module
Display Format	Graphic 240 x 64 dots
Input Data	Parallel data input from MPU
Multiplexing Ratio	1/64 Duty
Bias	1/9 Bias
Viewing Direction	6 O'clock
Backlight	LED

3. MECHANICAL SPECIFICATION

Item	Specifications	Unit
Dimensional outline	180.0x 65.0 x 13.8(max)	mm
Resolution	240segs x 64coms	dots
Active area	127.16(W) x 33.88(H)	mm
Dots pitch	0.53 (W)×0.53(H)	mm
Dots size	0.49(W)×0.49(H)	mm

4. MECHANICAL DIMENSION

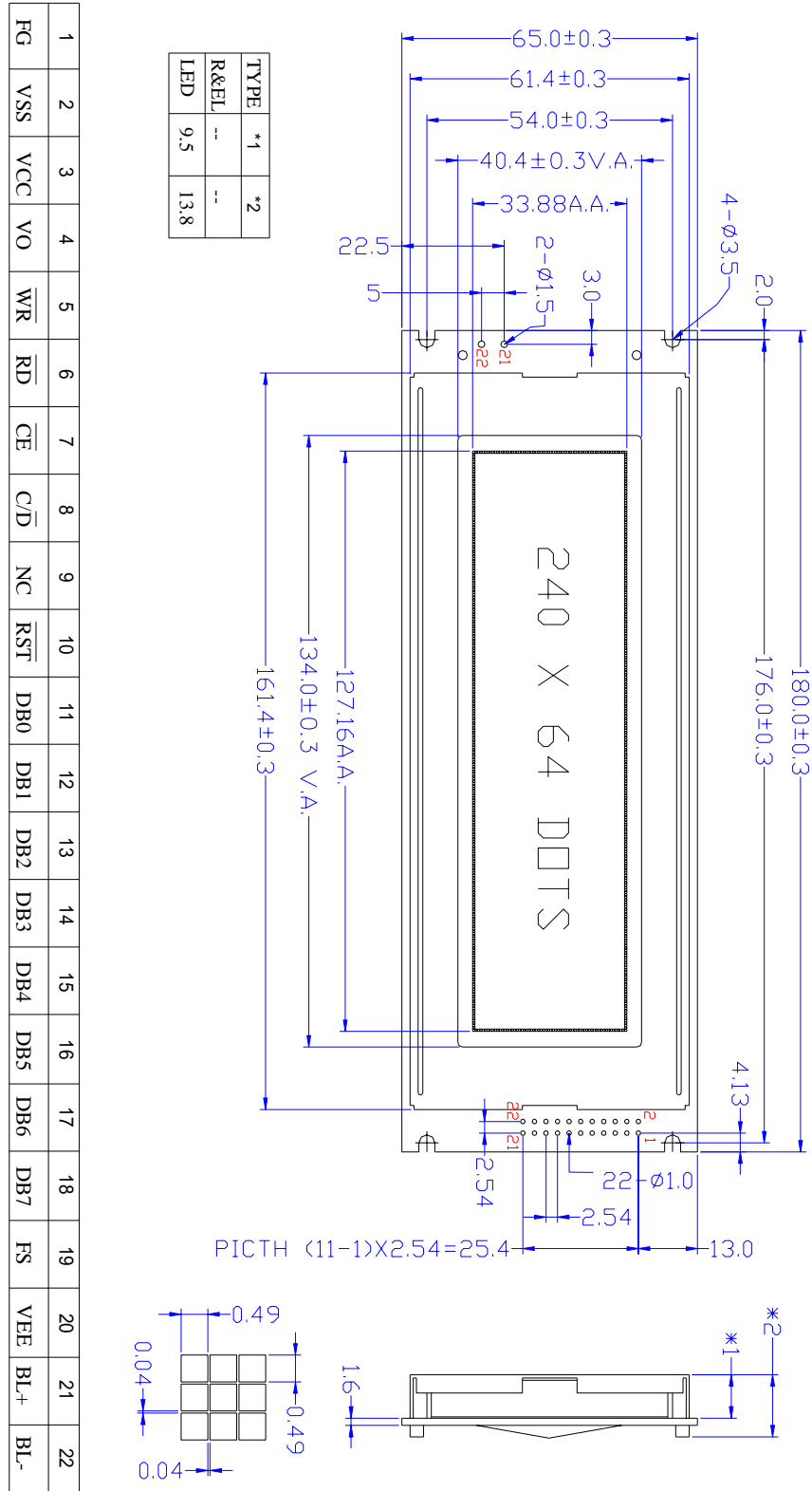

5. MAXIMUM RATINGS

Item	Symbol	Min	Max	Unit	Note
Supply voltage	$V_{DD} - V_{SS}$	-0.3	6.0	V	
	V_{LCD}	-0.3	24.0	V	
Input Voltage	V_{IN}	-0.3	$V_{DD}+0.3$	V	
Operating temperature	T_{OPR}	-10	+60	°C	
Storage temperature	T_{STR}	-20	+70	°C	
Humidity	---	---	90	%RH	

6. ELECTRICAL CHARACTERISTICS

Item		Symbol	Condition	Min.	Typ.	Max.	Unit
Supply Voltage	Logic	V_{DD}	---	---	5.0	---	V
Input Voltage	H level	V_{IH}	---	$0.8V_{DD}$	---	V_{DD}	V
	L level	V_{IL}		V_{SS}	---	$0.2V_{DD}$	
Current Consumption (LCD DRIVER)		I_{DD}	$V_{DD}=5.0V;$ $V_{LCD}=15.7V,$ $T_{amb}=25^{\circ}C;$	---	---	25.0	mA
LCD Driving Voltage		V_{LCD}	Bias=1/9 $V_{LCD}=V_{DD}-V_0$	---	15.7	---	V
Current Consumption (With LED BackLight)		I_{LED}	$V_{DD}=5.0V;$ $V_{LED}=4.2V, T_{amb}=25^{\circ}C;$	---	---	500	mA

7. MODULE FUNCTION DESCRIPTION

7.1. PIN DESCRIPTION

Pin No.	Symbol	Description
1	FG	Ground
2	VSS	Power supply for Ground (0V)
3	VCC	Power supply for positive (5V)
4	VO	LCD driver voltage regulation pin
5	/WR	Write enable signal
6	/RD	Read enable signal
7	/CE	Chip enable signal
8	C/D	Data/command signed select, "H": Command; "L": Data
9	NC	No signal
10	RST	Reset signal input pin
11	DB0	8-bit bi-directional data bus
12	DB1	
13	DB2	
14	DB3	
15	DB4	
16	DB5	
17	DB6	
18	DB7	
19	FS	Font selection; "H": 6*8; "L": 8*8
20	VEE	Negative voltage for LCD driving
21	BL+	Backlight power supply voltage for positive
22	BL-	Backlight power supply voltage for negative

7.2 TIMING CHARACTERISTICS

Ac Characteristics

- Switching Characteristics (1)

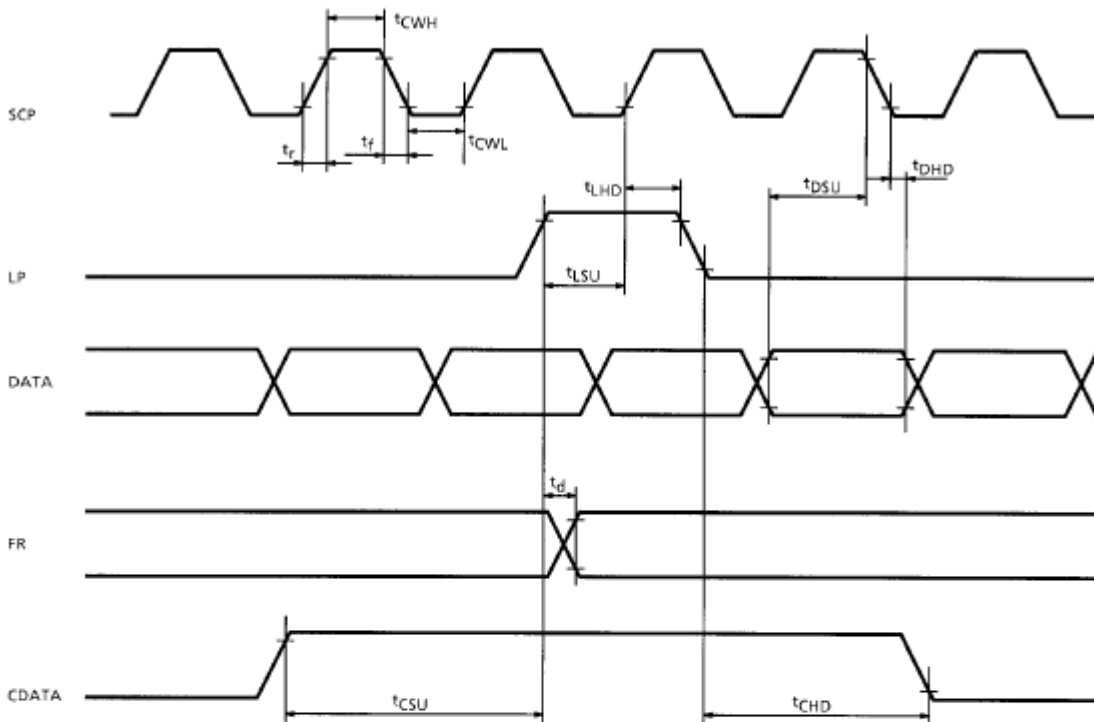

Test Conditions (Unless Otherwise Noted, $V_{DD} = 5.0\text{ V} \pm 10\%$, $V_{SS} = 0\text{ V}$, $T_a = -20\text{ to }70^\circ\text{C}$)

Item	Symbol	Test Conditions	Min	Max	Unit
Operating Frequency	f_{SCP}	$T_a = -10\sim 70^\circ\text{C}$	—	2.75	MHz
SCP Pulse Width	t_{CWH}, t_{CWL}	—	150	—	ns
SCP Rise / Fall Time	t_r, t_f	—	—	30	ns
LP Set-up Time	t_{LSU}	—	150	290	ns
LP Hold Time	t_{LHD}	—	5	40	ns
Data Set-up Time	t_{DSU}	—	170	—	ns
Data Hold Time	t_{DHD}	—	80	—	ns
FR Delay Time	t_d	—	0	90	ns
CDATA Set-up Time	t_{CSU}	—	450	850	ns
CDATA Hold Time	t_{CHD}	—	450	950	ns

• Switching Characteristics (2)

Bus Timing

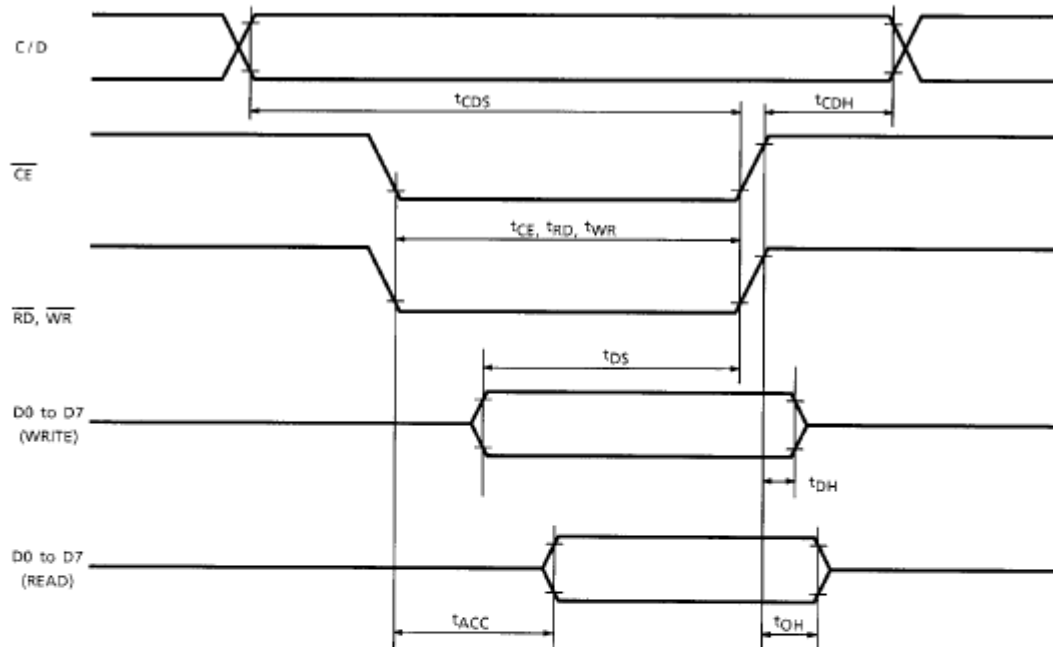
Test Conditions (Unless Otherwise Noted, $V_{DD} = 5.0\text{ V} \pm 10\%$, $V_{SS} = 0\text{ V}$, $T_a = -20\text{ to }75^\circ\text{C}$)

Item	Symbol	Test Conditions	Min	Max	Unit
C / D Set-up Time	t_{CDS}	—	100	—	ns
C / D Hold Time	t_{CDH}	—	10	—	ns
\overline{CE} , \overline{RD} , \overline{WR} Pulse Width	t_{CE}, t_{RD}, t_{WR}	—	80	—	ns
Data Set-up Time	t_{DS}	—	80	—	ns
Data Hold Time	t_{DH}	—	40	—	ns
Access Time	t_{ACC}	—	—	150	ns
Output Hold Time	t_{OH}	—	10	50	ns

• **Switching Characteristics (3)**

(1) External RAM Read mode

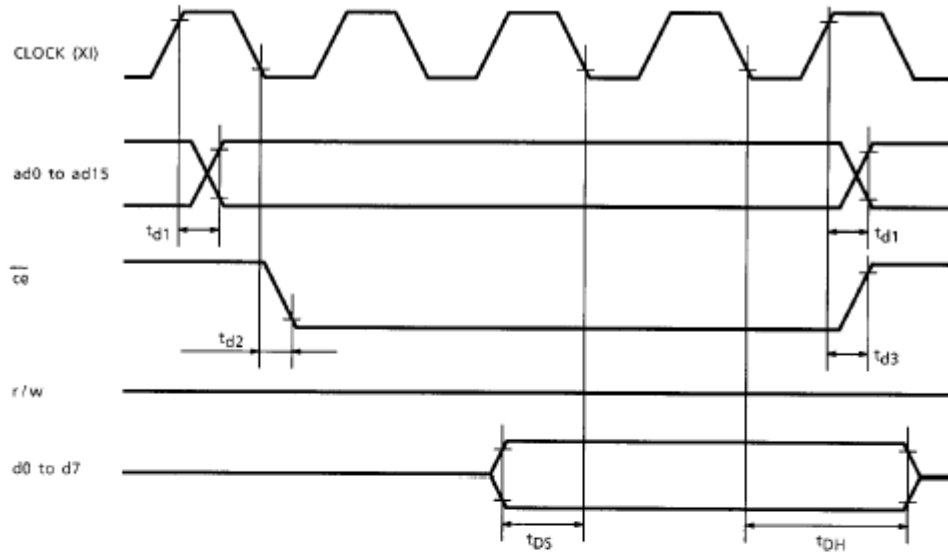

(2) External RAM Write mode

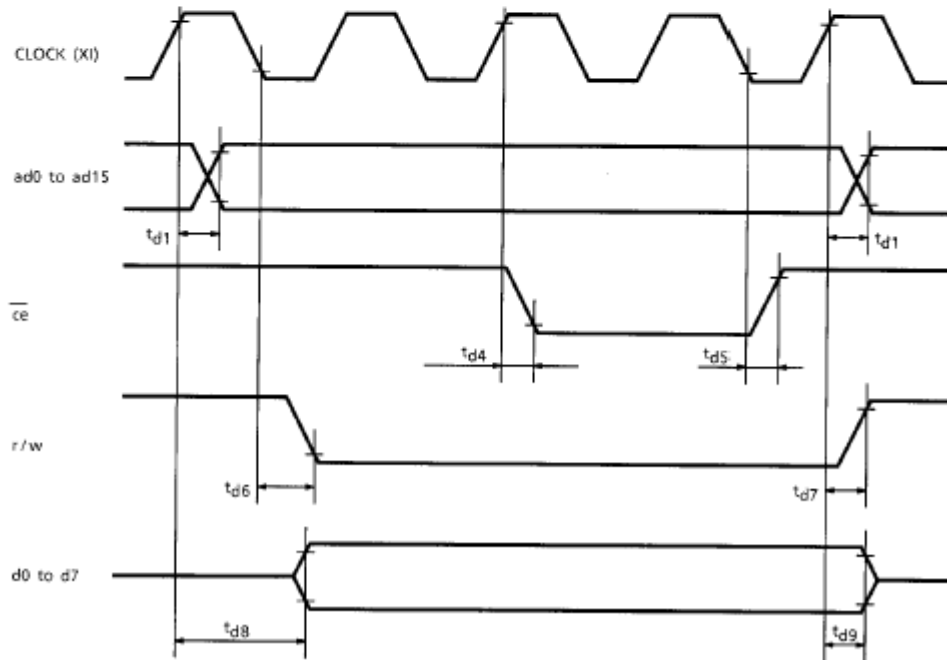



Test Conditions (Unless Otherwise Noted, $V_{DD} = 5.0\text{ V} \pm 10\%$, $V_{SS} = 0\text{ V}$, $T_a = -20\text{ to }70^\circ\text{C}$)

Item	Symbol	Test Conditions	Min	Max	Unit
Address Delay Time	t_{d1}	—	—	250	ns
$\overline{\text{ce}}$ Fall Delay Time (Read)	t_{d2}	—	—	180	ns
$\overline{\text{ce}}$ Rise Delay Time (Read)	t_{d3}	—	—	180	ns
Data Set-up Time	t_{DS}	—	0	—	ns
Data Hold Time	t_{DH}	—	30	—	ns
$\overline{\text{ce}}$ Fall Delay Time (Write)	t_{d4}	—	—	200	ns
$\overline{\text{ce}}$ Rise Delay Time (Write)	t_{d5}	—	—	200	ns
r / w Fall Delay Time	t_{d6}	—	—	180	ns
r / w Rise Delay Time	t_{d7}	—	—	180	ns
Data Stable Time	t_{d8}	—	—	450	ns
Data Hold Time	t_{d9}	—	—	200	ns

7.3 APPLICATION OF LCM

■Circuit Block Diagram

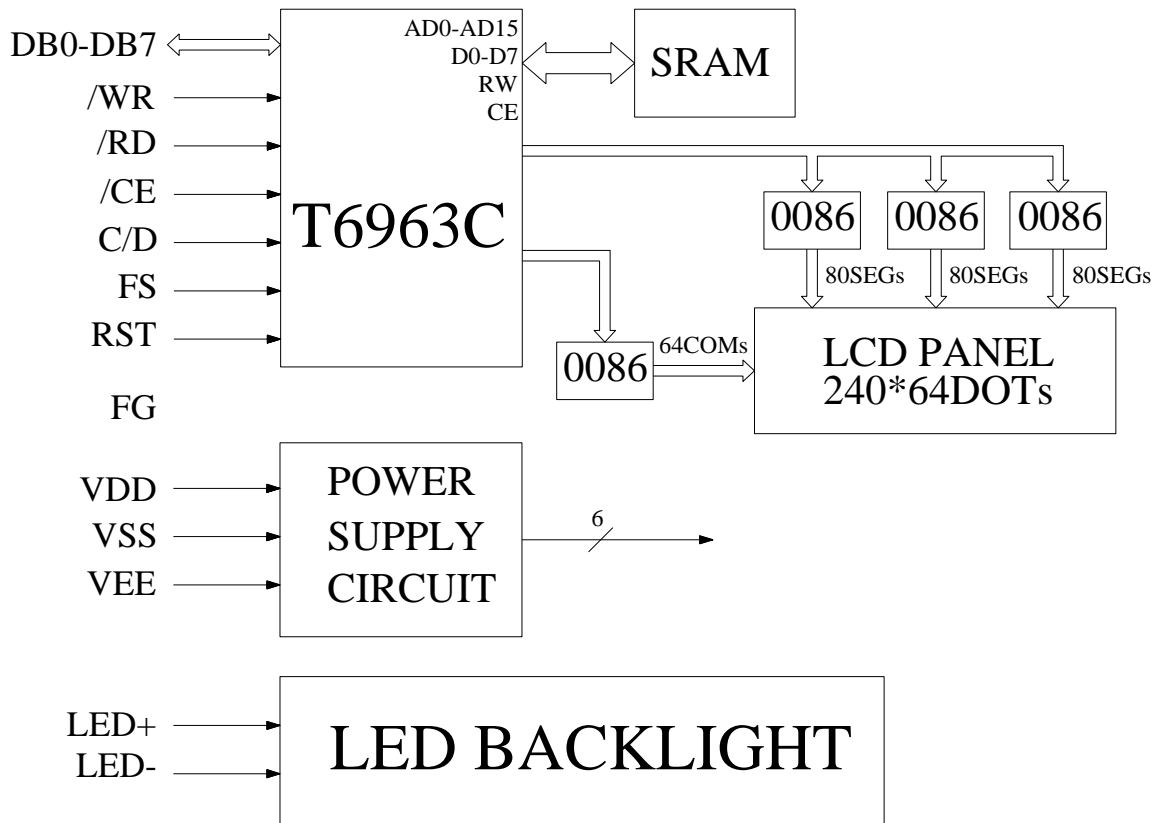



7.4 TABLE OF COMMAND

Command	Code	D1	D2	Function
REGISTERS SETTING	00100001 00100010 00100100	X address Data Low address	Y address 00H High address	Set Cursor Pointer Set Offset Register Set Address Pointer
SET CONTROL WORD	01000000 01000001 01000010 01000011	Low address Columns Low address Columns	High address 00H High address 00H	Set Text Home Address Set Text Area Set Graphic Home Address Set Graphic Area
MODE SET	1000X000 1000X001 1000X011 1000X100 10000XXX 10001XXX	— — — — — —	— — — — — —	OR mode EXOR mode AND mode Text Attribute mode Internal CG ROM mode External CG RAM mode
DISPLAY MODE	10010000 1001XX10 1001XX11 100101XX 100110XX 100111XX	— — — — — —	— — — — — —	Display off Cursor on, blink off Cursor on, blink on Text on, graphic off Text off, graphic on Text on, graphic on
CURSOR PATTERN SELECT	10100000 10100001 10100010 10100011 10100100 10100101 10100110 10100111	— — — — — — — —	— — — — — — — —	1-line cursor 2-line cursor 3-line cursor 4-line cursor 5-line cursor 6-line cursor 7-line cursor 8-line cursor
DATA AUTO READ / WRITE	10110000 10110001 10110010	— — —	— — —	Set Data Auto Write Set Data Auto Read Auto Reset
DATA READ / WRITE	11000000 11000001 11000010 11000011 11000100 11000101	Data — Data — Data —	— — — — — —	Data Write and Increment ADP Data Read and Increment ADP Data Write and Decrement ADP Data Read and Decrement ADP Data Write and Nonvariable ADP Data Read and Nonvariable ADP
SCREEN PEEK	11100000	—	—	Screen Peek
SCREEN COPY	11101000			Screen Copy

X: invalid

Command	Code	D1	D2	Function
BIT SET / RESET	11110XXX	—	—	Bit Reset
	11111XXX	—	—	Bit Set
	1111X000	—	—	Bit 0 (LSB)
	1111X001	—	—	Bit 1
	1111X010	—	—	Bit 2
	1111X011	—	—	Bit 3
	1111X100	—	—	Bit 4
	1111X101	—	—	Bit 5
	1111X110	—	—	Bit 6
	1111X111	—	—	Bit 7 (MSB)

X: invalid

7.5 RAM INTERFACE

- **RAM Interface**

The external RAM is used to store display data (text, graphic and external CG data).

With single-scan, text data, graphic data and external CG data can be freely allocated to the memory area (64 KB max).

With dual-scan, LCD I is allocated to 0000H to 7FFFH (32 KB max), LCD II is allocated to 8000H to FFFFH (32 KB max). Text data, graphic data and external CG data can be freely allocated in LCD I. In LCDII, the same addresses must be allocated as in LCD I, except ad15. ad15 determines selection of LCD I or LCD II.

It can be use the address decoded signals $\overline{ce0}$ (0000 to 07FFFH), $\overline{ce1}$ (0800 to 0FFFFH) within 4 KB. $\overline{ce0}$ and $\overline{ce1}$ allow decoding of addresses in the ranges (0000 to 07FFFH) and (0800 to 0FFFFH) respectively within a 4-KB memory space.

(Example)

(1) Single-Scan



(2) Dual-Scan

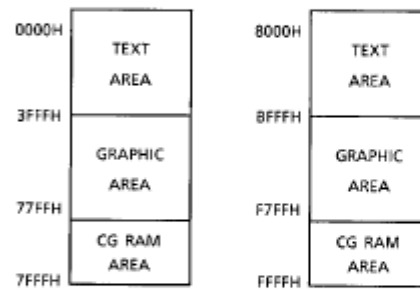

CG : Character Generator



7.6 FLOWCHART OF COMMUNICATION WITH MPU

• Flowchart of communications with MPU

(1) Status Read

A status check must be performed before data is read or written.

Status check

The Status of T6963C can be read from the data lines.

\overline{RD}	L
\overline{WR}	H
\overline{CE}	L
C / D	H
D0 to D7	Status word

The T6963C status word format is as follows:

MSB				LSB			
STA7 D7	STA6 D6	STA5 D5	STA4 D4	STA3 D3	STA2 D2	STA1 D1	STA0 D0
STA0	Check command execution capability					0: Disable 1: Enable	
STA1	Check data read / write capability					0: Disable 1: Enable	
STA2	Check Auto mode data read capability					0: Disable 1: Enable	
STA3	Check Auto mode data write capability					0: Disable 1: Enable	
STA4	Not used						
STA5	Check controller operation capability					0: Disable 1: Enable	
STA6	Error flag. Used for Screen Peek and Screen copy commands.					0: No error 1: Error	
STA7	Check the blink condition					0: Display off 1: Normal display	

Note 1: It is necessary to check STA0 and STA1 at the same time.

There is a possibility of erroneous operation due to a hardware interrupt.

Note 2: For most modes STA0 / STA1 are used as a status check.

Note 3: STA2 and STA3 are valid in Auto mode; STA0 and STA1 are invalid.

Status checking flow

a)

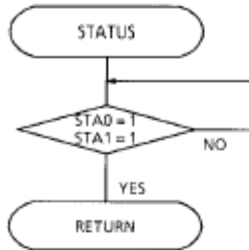

b)

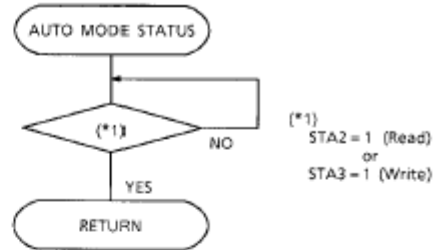

Note 4: When using the MSB = 0 command, a Status Read must be performed.

If a status check is not carried out, the T6963C cannot operate normally, even after a delay time.

The hardware interrupt occurs during the address calculation period (at the end of each line).

If a MSB = 0 command is sent to the T6963C during this period, the T6963C enters Wait status.

If a status check is not carried out in this state before the next command is sent, there is the possibility that the command or data will not be received.

(2) Setting data

When using the T6963C, first set the data, then set the command.

Procedure for sending a command

a) The case of 1 data



b) The case of 2 data

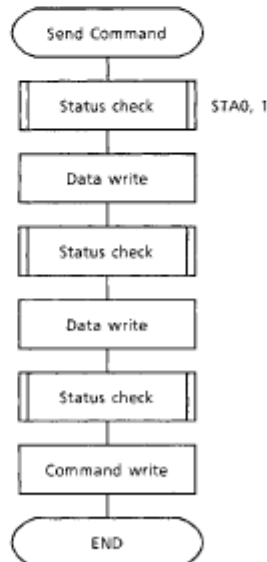

Note: When sending more than two data, the last datum (or last two data) is valid.

8. ELECTRO-OPTICAL CHARACTERISTICS

Item	Symbol	Condition	Temp	Min	Typ.	Max	Units	Note
LCD driving voltage	V _{LCD}	$\theta = \phi = 0$	0°C	---	16.0	---	V	NOTE1
			25°C	15.2	15.7	16.2		
			50°C	---	15.4	---		
Response Time	Rise Time (Tr)	$\theta = \phi = 0$	0°C	---	---	--	msec	NOTE2
	Decay Time (Tf)			---	---	---		
	Rise Time (Tr)		25°C	---	225	340		
	Decay Time (Tf)			---	240	360		
	Rise Time (Tr)		50°C	---	---	--		
	Decay Time (Tf)			---	---	--		
Contrast Ratio	Cr	$\theta = \phi = 0$	25°C	5	10	---	---	NOTE4

Viewing Angle Range	$\theta (\phi = 0^\circ)$ (6'')	$\phi = 90^\circ$ (3'')	$\phi = 180^\circ$ (12'')	$\phi = 270^\circ$ (9'')	備註
$\theta (25^\circ\text{C})$ CR≥2	45	35	25	35	Deg NOTE3

● For panel only

• **Electro-Optical Characteristics Measuring Equipment(DMS501)**

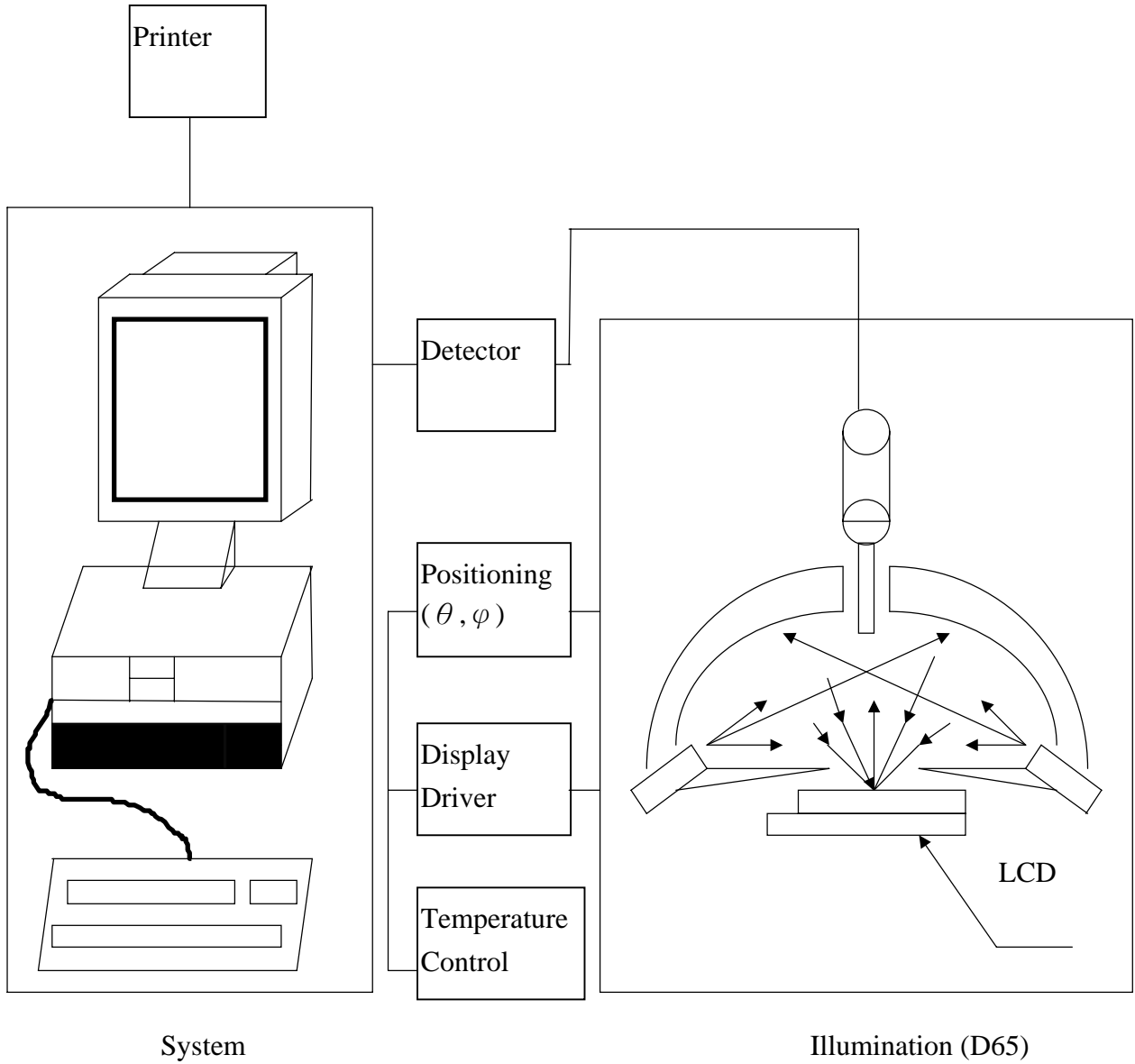

• **Note 1. Definition of Driving Voltage(V_{lcd}) :**

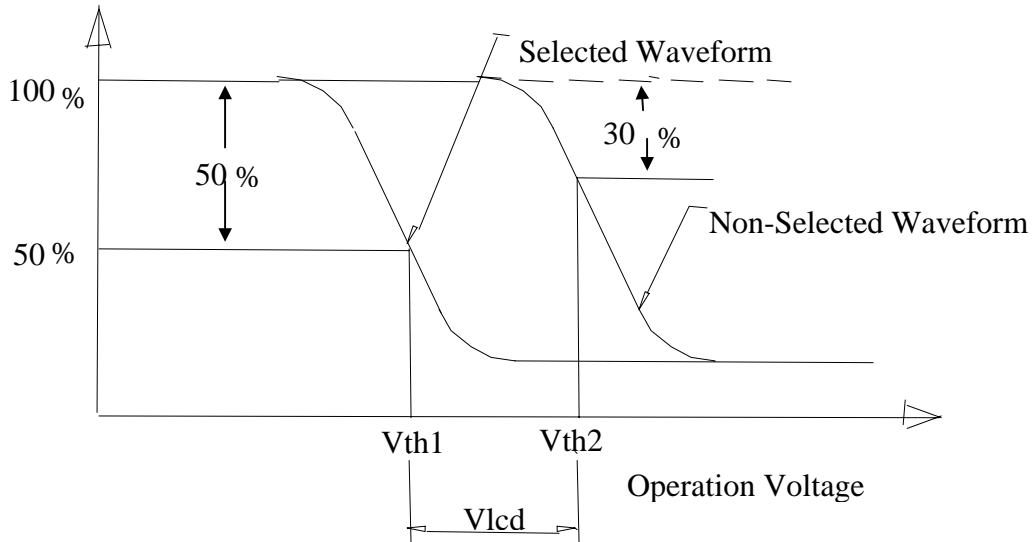

• **Note 2. Definition of Optical Response Time :**

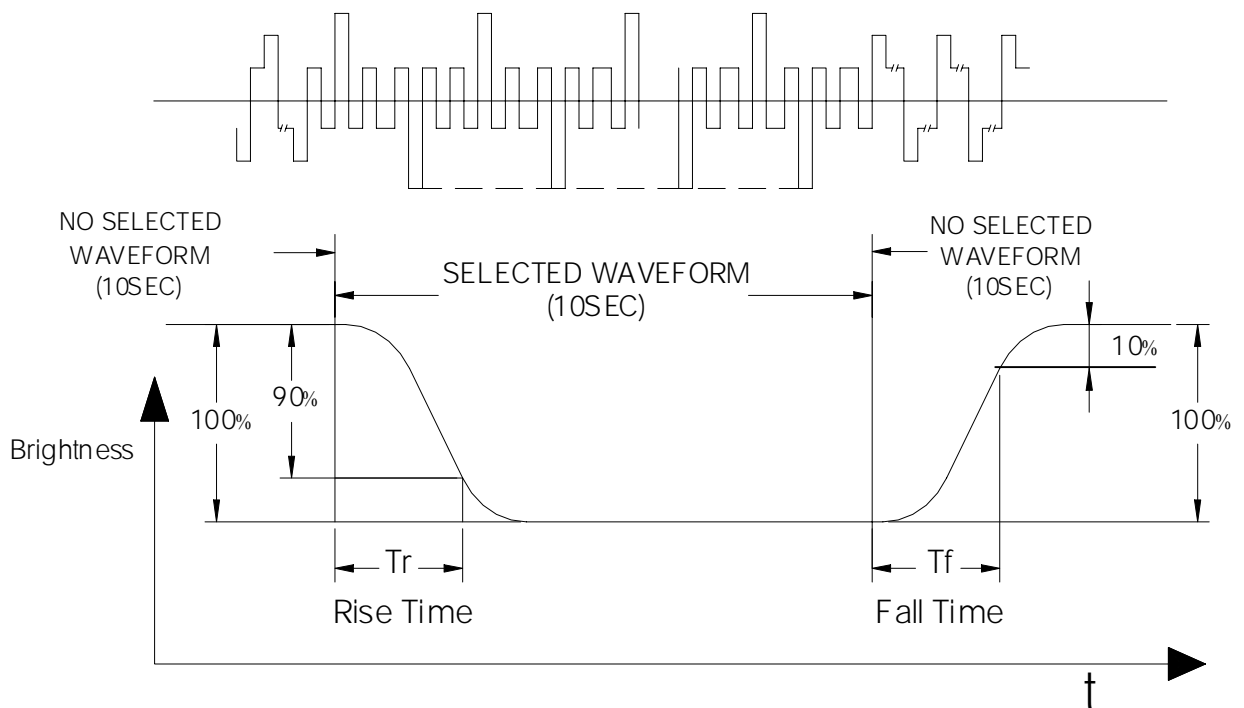

• **Note 3. Definition of Viewing Angle θ and ϕ :**

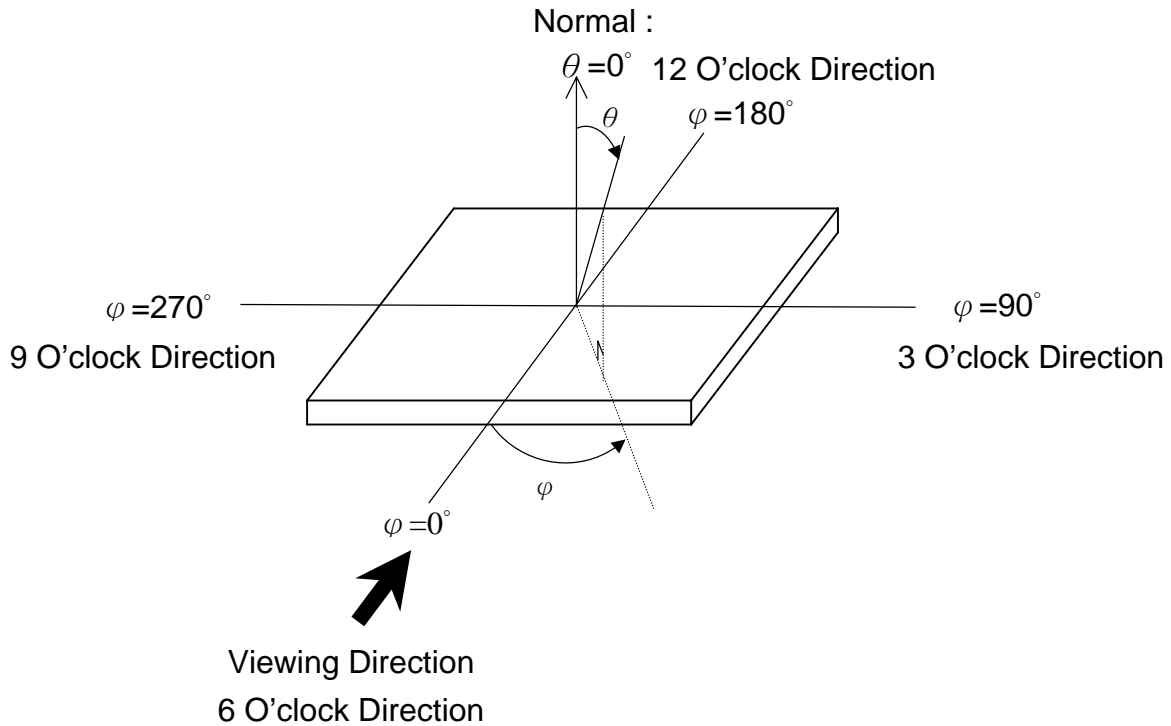

• **Note 4. Definition of Contrast ratio(CR) :**

$$CR = \frac{\text{Brightness of Non-selected Segment (B2)}}{\text{Brightness of Selected Segment (B1)}}$$

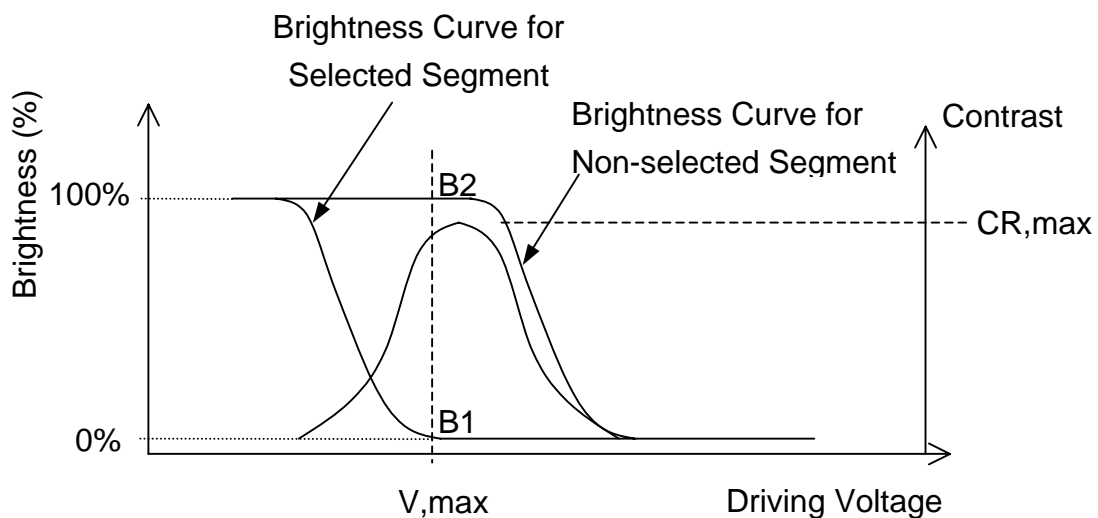

9. RELIABILITY

9.1. MTBF

The LCD module shall be designed to meet a minimum MTBF value of 50000 hours with normal. (25°C in the room without sunlight)

9.2. TESTS

NO.	ITEM	CONDITION	CRITERION
1	High Temperature Operating	50°C 120Hrs	<ul style="list-style-type: none"> ◦ No Defect Of Operational Function In Room Temperature Are Allowable. ◦ IDD of LCM in Pre-and post-test should follow specification
2	Low Temperature Operating	0°C 120Hrs	
3	High Temperature/ Humidity Non-Operating	60°C ,90%RH ,120 Hrs	
4	High Temperature Non-Operating	70°C 120Hrs	
5	Low Temperature Non-Operating	-20°C 120Hrs	
6	Temperature Cycling Non-Operating	-10°C (30Min)↔ 60°C (30Min) 10 CYCLES	

Notes: Judgments should be made after exposure in room temperature for two hours.

10. PRECAUTIONS FOR USING LCD MODULES

10.1. HANDLING PRECAUTIONS

- (1) The display panel is made of glass. Do not subject it to a mechanical shock or impact by dropping it.
- (2) If the display panel is damaged and the liquid crystal substance leaks out, be sure not to get any in your mouth. If the substance contacts your skin or clothes, wash it off using soap and water.
- (3) Do not apply excessive force to the display surface or the adjoining areas since this may cause the color tone to vary.
- (4) The polarizer covering the display surface of the LCD module is soft and easily scratched. Handle this polarizer carefully.
- (5) If the display surface becomes contaminated, breathe on the surface and gently wipe it with a soft dry cloth. If it is heavily contaminated, moisten a cloth with one of the following solvents:
 - Isopropyl alcohol
 - Ethyl alcohol
- (6) Solvents other than those above mentioned may damage the polarizer.
Especially, do not use the following:
 - Water
 - Ketone
 - Aromatic solvents
- (7) Extra care to minimize corrosion of the electrode. Water droplets, moisture condensation or a current flow in a high-humidity environment accelerates corrosion of the electrode.
- (8) Install the LCD Module by using the mounting holes. When mounting the LCD Module, make sure it is free of twisting, warping and distortion. In particular, do not forcibly pull or bend the I/O cable or the backlight cable.
- (9) Do not attempt to disassemble or process the LCD Module.
- (10) NC terminal should be open. Do not connect anything.
- (11) If the logic circuit power is off, do not apply the input signals.
- (12) To prevent destruction of the elements by static electricity, be careful to maintain an optimum work environment.
 - Be sure to ground the body when handling the LCD Module.
 - Tools required for assembling, such as soldering irons, must be properly grounded.
 - To reduce the amount of static electricity generated, do not conduct assembling and other work under dry conditions.

-The LCD Module is coated with a film to protect the display surface. Exercise care when peeling off this protective film since static electricity may be generated.

10.2. STORAGE CONDITIONS

When storing, avoid the LCD module to be exposed to direct sunlight of fluorescent lamps. For stability, to keep it away from high temperature and high humidity environment (The best condition is : $23\pm 5^{\circ}\text{C}$, $45\pm 20\%\text{RH}$). ESD protection is necessary for long-term storage also.

10.3. OTHERS

Liquid crystals solidify under low temperature (below the storage temperature range) leading to defective orientation or the generation of air bubbles (black or white). Air bubbles may also be generated if the module is subject to a low temperature.

If the LCD Module have been operating for a long time showing the same display patterns the display patterns may remain on the screen as ghost images and a slight contrast irregularity may also appear. A normal operating status can be recovered by suspending use for some time. It should be noted that this phenomenon does not adversely affect performance reliability.

To minimize the performance degradation of the LCD Module resulting from destruction caused by static electricity etc. exercise care to avoid holding the following sections when handling the modules.

- Exposed area of the printed circuit board.
- Terminal electrode sections.

11. Using LCD modules

11.1 LIQUID CRYSTAL DISPLAY MODULES

LCD is composed of glass and polarizer. Pay attention to the following items when handling.

- (1) Please keep the temperature within specified range for use and storage. Polarization degradation, bubble generation or polarizer peel-off may occur with high temperature and high humidity.
- (2) Do not touch, push or rub the exposed polarizers with anything harder than a HB pencil lead (glass, tweezers, etc).
- (3) N-hexane is recommended for cleaning the adhesives used to attach front/rear polarizers and reflectors made of organic substances, which will be damaged by chemicals such as acetone, toluene, toluene, ethanol and isopropyl alcohol.
- (4) When the display surface becomes dusty, wipe gently with absorbent cotton or other soft material like chamois soaked in petroleum ether. Do not scrub hard to avoid damaging the display surface.
- (5) Wipe off saliva or water drops immediately, contact with water over a long period of time may cause deformation or color fading.
- (6) Avoid contacting oil and fats.
- (7) Condensation on the surface and contact with terminals due to cold will damage, stain or polarizers. After products are tested at low temperature they must be warmed up in a container before coming is contacting with room temperature air.
- (8) Do not put or attach anything on the display area to avoid leaving marks on.
- (9) Do not touch the display with bare hands. This will stain the display area and degrade insulation between terminals (some cosmetics are determinate to the polarizers).
- (10) As glass is fragile, it tends to become or chipped during handling especially on the edges. Please avoid dropping or jarring.

11.2 INSTALLING LCD MODULE

Attend to the following items when installing the LCM.

- (1) Cover the surface with a transparent protective plate to protect the polarizer and LC cell.
- (2) When assembling the LCM into other equipment, the spacer to the bit between the LCM and the fitting plate should have enough height to avoid causing stress to the module surface, refer to the individual specifications for measurements. The measurement tolerance should be ± 0.1 mm.

11.3 ELECTRO-STATIC DISCHARGE CONTROL

Since this module uses a CMOS LSI, the same careful attention should be paid for electrostatic discharge as for an ordinary CMOS IC.

- (1) Make certain that you are grounded when handing LCM.
- (2) Before removing LCM from its packing case or incorporating it into a set, be sure the module and your body have the same electric potential.
- (3) When soldering the terminal of LCM, make certain the AC power source for the soldering iron does not leak.
- (4) When using an electric screwdriver to attach LCM, the screwdriver should be of ground potentiality to minimize as much as possible any transmission of electromagnetic waves produced sparks coming from the commutator of the motor.
- (5) As far as possible, make the electric potential of your work clothes and that of the workbenches to the ground potential.
- (6) To reduce the generation of electro-static discharge, be careful that the air in the work is not too dried. A relative humidity of 50%-60% is recommended.

11.4 PRECAUTIONS FOR OPERATION

- (1) Viewing angle varies with the change of liquid crystal driving voltage (V_o). Adjust V_o to show the best contrast.
- (2) Driving the LCD in the voltage above the limit will shorten its lifetime.
- (3) Response time is greatly delayed at temperature below the operating temperature range. However, this does not mean the LCD will be out of the order. It will recover when it returns to the specified temperature range.
- (4) If the display area is pushed hard during operation, the display will become abnormal. However, it will return to normal if it is turned off and then on.
- (5) Condensation on terminals can cause an electrochemical reaction disrupting the terminal circuit. Therefore, this product must be used and stored within the specified condition of $23\pm 5^{\circ}\text{C}$, $45\pm 20\% \text{RH}$.
- (6) When turning the power on, input each signal after the positive/negative voltage becomes stable.

11.5 SAFETY

- (1) It is recommended to crush damaged or unnecessary LCDs into pieces and wash them off with solvents such as acetone and ethanol, which should later be burned.
- (2) If any liquid leaks out of a damaged glass cell and comes in contact with the hands, wash off thoroughly with soap and water.

SAMPLE APPROVED REPORT (样品确认单)

SAMPLE MODEL NO. (样品型号)	GB24064A
SAMPLE SERIES NUMBER NO. (样品序号)	
SAMPLE QUANTITY (样品数量)	
COLOR/TYPE (底色/类型)	
VIEWING DIRECTION (视角)	
DRIVING METHOD (驱动参数)	1/64Duty, 1/9Bias
IC DRIVING VOLTAGE (IC 驱动电压)	5.0V
LCD VOP (LCD 操作电压)	
OPERATING TEMP. (操作温度)	
STORAGE TEMP. (储存温度)	
POLARIZER----FRONT (首偏光片)	
POLARIZER----BACK (后偏光片)	
CONTROLLER/DRIVER IC(控制/驱动 IC)	T6963C/S6B0086
BACKLIGHT COLOR/TYPE (背光源类型/颜色)	
DRAWING REV/NO./QUANTITY (图纸版本/数量)	
SPECIFICATION (规格书 份数)	
REMARKS : (备注)	
WRIT BY : _____ DATE : _____ APROV BY : _____ DATE : _____	
CUSTOMER'S APPROVAL (客户确认) :	
1) FUNCTION (功能) : <input type="checkbox"/> OK <input type="checkbox"/> N.G.	
2) DRIVER CONDITION (驱动条件) : <input type="checkbox"/> OK <input type="checkbox"/> N.G.	
3) DISPLAY MODE (显示模式) : <input type="checkbox"/> OK <input type="checkbox"/> N.G.	
4) VIEWING ANGLE (视角) : <input type="checkbox"/> OK <input type="checkbox"/> N.G.	
5) BACKLIGHT (背光源) : <input type="checkbox"/> OK <input type="checkbox"/> N.G.	
6) DISPLAYING PATTERN (显示效果) : <input type="checkbox"/> OK <input type="checkbox"/> N.G.	
CUSTOMER'S CONCLUSIONS (客户意见) : _____	

CUSTOMER'S SIGNATURE (客户签名) : _____ DATE (日期) : _____	