

80C186EC/80C188EC AND 80L186EC/80L188EC 16-BIT HIGH-INTEGRATION EMBEDDED PROCESSORS

- Fully Static Operation
- True CMOS Inputs and Outputs
- Integrated Feature Set:
 - Low-Power, Static, Enhanced 8086 CPU Core
 - Two Independent DMA Supported UARTs, each with an Integral Baud Rate Generator
 - Four Independent DMA Channels
 - 22 Multiplexed I/O Port Pins
 - Two 8259A Compatible Programmable Interrupt Controllers
 - Three Programmable 16-Bit Timer/Counters
 - 32-Bit Watchdog Timer
 - Ten Programmable Chip Selects with Integral Wait-State Generator
 - Memory Refresh Control Unit
 - Power Management Unit
 - On-Chip Oscillator
 - System Level Testing Support (ONCE Mode)
- Direct Addressing Capability to 1 Mbyte Memory and 64 Kbyte I/O
- Low-Power Operating Modes:
 - Idle Mode Freezes CPU Clocks but Keeps Peripherals Active
 - Powerdown Mode Freezes All Internal Clocks
 - Powersave Mode Divides All Clocks by Programmable Prescaler
- Available in Extended Temperature Range (–40°C to +85°C)
- Supports 80C187 Numerics Processor Extension (80C186EC only)
- Package Types:
 - 100-Pin EIAJ Quad Flat Pack (QFP)
 - 100-Pin Plastic Quad Flat Pack (PQFP)
 - 100-Pin Shrink Quad Flat Pack (SQFP)
- Speed Versions Available (5V):
 - 25 MHz (80C186EC25/80C188EC25)
 - 20 MHz (80C186EC20/80C188EC20)
 - 13 MHz (80C186EC13/80C188EC13)
- Speed Version Available (3V):
 - 13 MHz (80L186EC13/80L188EC13)
 - 8 MHz (80L186EC8/80L188EC8)

The 80C186EC is a member of the 186 Integrated Processor Family. The 186 Integrated Processor Family incorporates several different VLSI devices all of which share a common CPU architecture: the 8086/8088. The 80C186EC uses the latest high density CHMOS technology to integrate several of the most common system peripherals with an enhanced 8086 CPU core to create a powerful system on a single monolithic silicon die.

80C186EC/80C188EC and 80L186EC/80L188EC 16-Bit High-Integration Embedded Processor

CONTENTS	PAGE
INTRODUCTION	1-194
80C186EC CORE ARCHITECTURE ...	1-194
Bus Interface Unit	1-194
Clock Generator	1-194
80C186EC PERIPHERAL ARCHITECTURE	1-195
Programmable Interrupt Controllers	1-197
Timer/Counter Unit	1-197
Serial Communications Unit	1-197
DMA Unit	1-197
Chip-Select Unit	1-197
I/O Port Unit	1-197
Refresh Control Unit	1-197
Watchdog Timer Unit	1-197
Power Management Unit	1-198
80C187 Interface (80C186EC only)	1-198
ONCE Test Mode	1-198
PACKAGE INFORMATION	1-198
Prefix Identification	1-198
Pin Descriptions	1-198
Pinout	1-205
Package Thermal Specifications	1-214
ELECTRICAL SPECIFICATIONS	1-215
Absolute Maximum Ratings	1-215

CONTENTS	PAGE
Recommended Connections	1-215
DC SPECIFICATIONS	1-216
I _{CC} versus Frequency and Voltage	1-218
PDTMR Pin Delay Calculation	1-218
AC SPECIFICATIONS	1-219
AC Characteristics—80C186EC25	1-219
AC Characteristics—80C186EC20/13 ..	1-221
AC Characteristics—80L186EC13	1-222
Relative Timings	1-223
Serial Port Mode 0 Timings	1-224
AC TEST CONDITIONS	1-225
AC TIMING WAVEFORMS	1-225
DERATING CURVES	1-228
RESET	1-228
BUS CYCLE WAVEFORMS	1-231
EXECUTION TIMINGS	1-238
INSTRUCTION SET SUMMARY	1-239
ERRATA	1-245
REVISION HISTORY	1-245

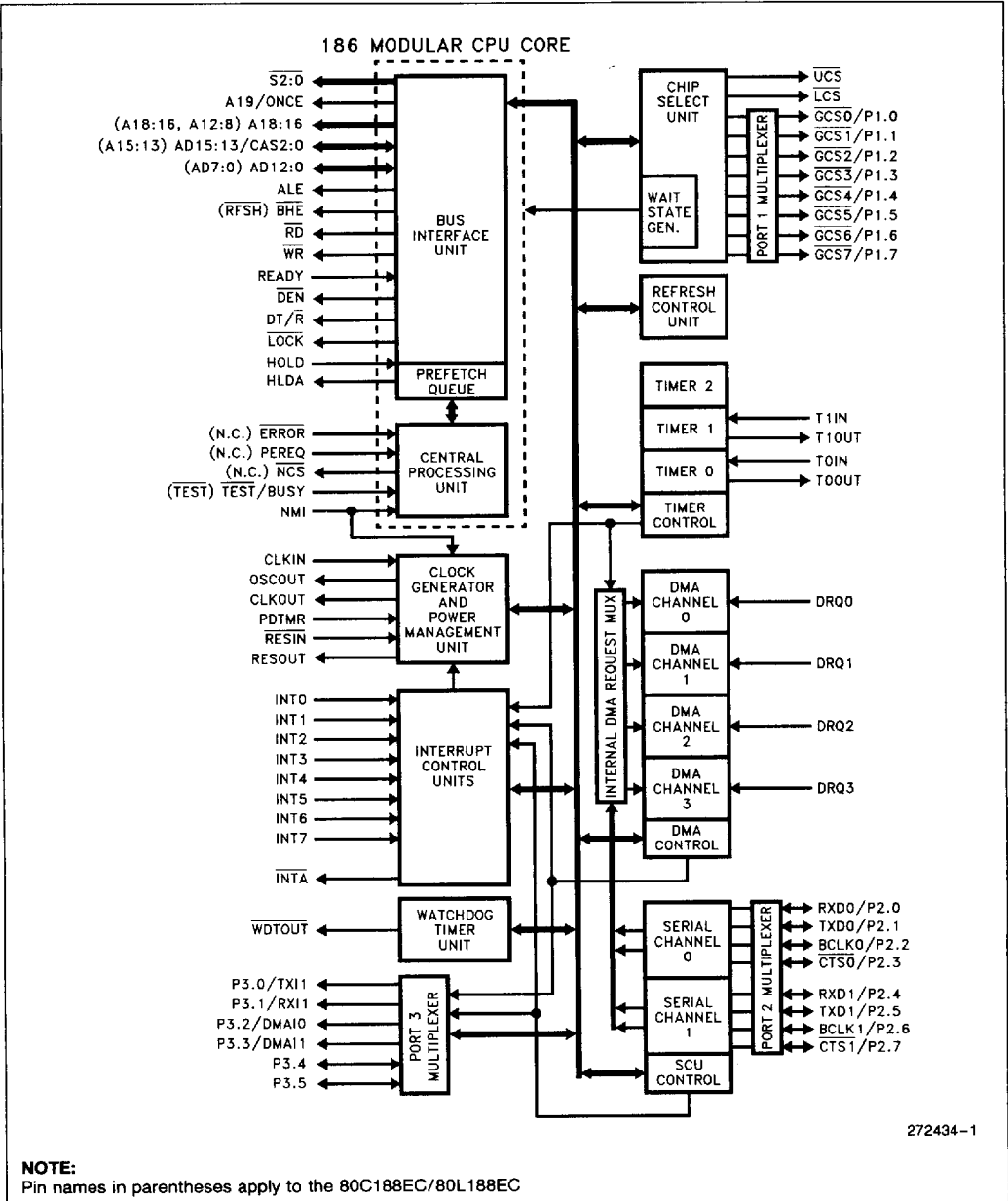

Figure 1. 80C186EC/80L186EC Block Diagram

INTRODUCTION

Unless specifically noted, all references to the 80C186EC apply to the 80C188EC, 80L186EC, and 80L188EC. References to pins that differ between the 80C186EC/80L186EC and the 80C188EC/80L188EC are given in parentheses. The "L" in the part number denotes low voltage operation. Physically and functionally, the "C" and "L" devices are identical.

The 80C186EC is one of the highest integration members of the 186 Integrated Processor Family. Two serial ports are provided for services such as interprocessor communication, diagnostics and modem interfacing. Four DMA channels allow for high speed data movement as well as support of the on-board serial ports. A flexible chip select unit simplifies memory and peripheral interfacing. The three general purpose timer/counters can be used for a variety of time measurement and waveform generation tasks. A watchdog timer is provided to insure system integrity even in the most hostile of environments. Two 8259A compatible interrupt controllers handle internal interrupts, and, up to 57 external interrupt requests. A DRAM refresh unit and 24 multiplexed I/O ports round out the feature set of the 80C186EC.

The future set of the 80C186EC meets the needs of low-power, space-critical applications. Low-power applications benefit from the static design of the CPU and the integrated peripherals as well as low voltage operation. Minimum current consumption is achieved by providing a powerdown mode that halts operation of the device and freezes the clock circuits. Peripheral design enhancements ensure that non-initialized peripherals consume little current.

The 80L186EC is the 3V version of the 80C186EC. The 80L186EC is functionally identical to the 80C186EC embedded processor. Current 80C186EC users can easily upgrade their designs to use the 80L186EC and benefit from the reduced power consumption inherent in 3V operation.

Figure 1 shows a block diagram of the 80C186EC/80C188EC. The execution unit (EU) is an enhanced 8086 CPU core that includes: dedicated hardware to speed up effective address calculations, enhanced execution speed for multiple-bit shift and rotate instructions and for multiply and divide instructions, string move instructions that operate at full bus bandwidth, ten new instructions and fully static operation. The bus interface unit (BIU) is the same as that found on the original 186 family products, except the queue-status mode has been deleted and buffer interface control has been changed to ease system design timings. An independent internal bus is used for communication between the BIU and on-chip peripherals.

80C186EC CORE ARCHITECTURE

Bus Interface Unit

The 80C186EC core incorporates a bus controller that generates local bus control signals. In addition, it employs a HOLD/HLDA protocol to share the local bus with other bus masters.

The bus controller is responsible for generating 20 bits of address, read and write strobes, bus cycle status information and data (for write operations) information. It is also responsible for reading data from the local bus during a read operation. A ready input pin is provided to extend a bus cycle beyond the minimum four states (clocks).

The bus controller also generates two control signals (\overline{DEN} and DT/\overline{R}) when interfacing to external transceiver chips. This capability allows the addition of transceivers for simple buffering of the multiplexed address/data bus.

Clock Generator

The 80C186EC provides an on-chip clock generator for both internal and external clock generation. The clock generator features a crystal oscillator, a divide-by-two counter and three low-power operating modes.

The oscillator circuit is designed to be used with either a parallel resonant fundamental or third-overtone mode crystal network. Alternatively, the oscillator circuit may be driven from an external clock source. Figure 2 shows the various operating modes of the oscillator circuit.

The crystal or clock frequency chosen must be twice the required processor operating frequency due to the internal divide-by-two counter. This counter is used to drive all internal phase clocks and the external CLKOUT signal. CLKOUT is a 50% duty cycle processor clock and can be used to drive other system components. All AC timings are referenced to CLKOUT.

The following parameters are recommended when choosing a crystal:

Temperature Range:	Application Specific
ESR (Equivalent Series Res.):	40Ω max
C0 (Shunt Capacitance of Crystal):	7.0 pF max
C _L (Load Capacitance):	20 pF ± 2 pF
Drive Level:	1 mW (max)

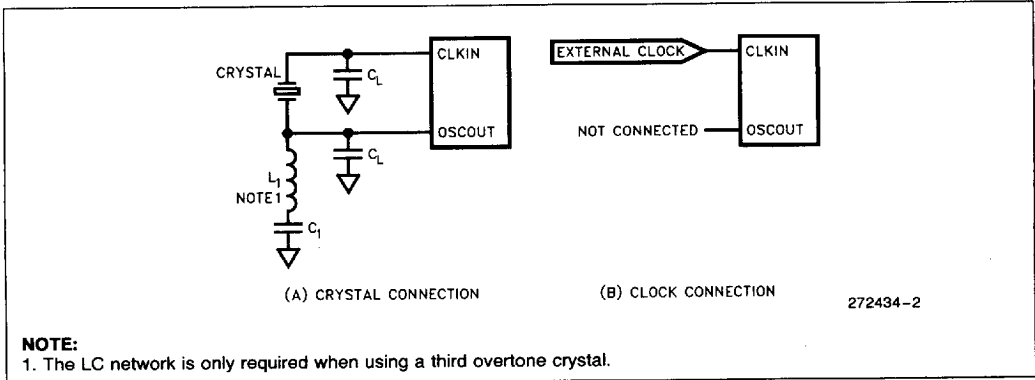

Figure 2. 80C186EC Clock Connections

80C186EC PERIPHERAL ARCHITECTURE

The 80C186EC integrates several common system peripherals with a CPU core to create a compact, yet powerful system. The integrated peripherals are designed to be flexible and provide logical interconnections between supporting units (e.g., the DMA unit can accept requests from the Serial Communications Unit).

The list of integrated peripherals includes:

- Two cascaded, 8259A compatible, Programmable Interrupt Controllers
- 3-Channel Timer/Counter Unit
- 2-Channel Serial Communications Unit
- 4-Channel DMA Unit

- 10-Output Chip-Select Unit
- 32-bit Watchdog Timer Unit
- I/O Port Unit
- Refresh Control Unit
- Power Management Unit

The registers associated with each integrated peripheral are contained within a 128 x 16-bit register file called the Peripheral Control Block (PCB). The base address of the PCB is programmable and can be located on any 256 byte address boundary in either memory or I/O space.

Figure 3 provides a list of the registers associated with the PCB. The Register Bit Summary individually lists all of the registers and identifies each of their programming attributes.

PCB Offset	Function	PCB Offset	Function	PCB Offset	Function	PCB Offset	Function
00H	Master PIC Port 0	40H	T2 Count	80H	GCS0 Start	C0H	DMA 0 Source Low
02H	Master PIC Port 1	42H	T2 Compare	82H	GCS0 Stop	C2H	DMA 0 Source High
04H	Slave PIC Port 0	44H	Reserved	84H	GCS1 Start	C4H	DMA 0 Dest. Low
06H	Slave PIC Port 1	46H	T2 Control	86H	GCS1 Stop	C6H	DMA 0 Dest. High
08H	Reserved	48H	Port 3 Direction	88H	GCS2 Start	C8H	DMA 0 Count
0AH	SCU Int. Req. Ltch.	4AH	Port 3 Pin State	8AH	GCS2 Stop	CAH	DMA 0 Control
0CH	DMA Int. Req. Ltch.	4CH	Port 3 Mux Control	8CH	GCS3 Start	CCH	DMA Module Pri.
0EH	TCU Int. Req. Ltch.	4EH	Port 3 Data Latch	8EH	GCS3 Stop	CEH	DMA Halt
10H	Reserved	50H	Port 1 Direction	90H	GCS4 Start	D0H	DMA 1 Source Low
12H	Reserved	52H	Port 1 Pin State	92H	GCS4 Stop	D2H	DMA 1 Source High
14H	Reserved	54H	Port 1 Mux Control	94H	GCS5 Start	D4H	DMA 1 Dest. Low
16H	Reserved	56H	Port 1 Data Latch	96H	GCS5 Stop	D6H	DMA 1 Dest. High
18H	Reserved	58H	Port 2 Direction	98H	GCS6 Start	D8H	DMA 1 Count
1AH	Reserved	5AH	Port 2 Pin State	9AH	GCS6 Stop	DAH	DMA 1 Control
1CH	Reserved	5CH	Port 2 Mux Control	9CH	GCS7 Start	DCH	Reserved
1EH	Reserved	5EH	Port 2 Data Latch	9EH	GCS7 Stop	DEH	Reserved
20H	WDT Reload High	60H	SCU 0 Baud	A0H	LCS Start	E0H	DMA 2 Source Low
22H	WDT Reload Low	62H	SCU 0 Count	A2H	LCS Stop	E2H	DMA 2 Source High
24H	WDT Count High	64H	SCU 0 Control	A4H	UCS Start	E4H	DMA 2 Dest. Low
26H	WDT Count Low	66H	SCU 0 Status	A6H	UCS Stop	E6H	DMA 2 Dest. High
28H	WDT Clear	68H	SCU 0 RBUF	A8H	Relocation Register	E8H	DMA 2 Count
2AH	WDT Disable	6AH	SCU 0 TBUF	AAH	Reserved	EAH	DMA 2 Control
2CH	Reserved	6CH	Reserved	ACH	Reserved	ECH	Reserved
2EH	Reserved	6EH	Reserved	AEH	Reserved	EEH	Reserved
30H	T0 Count	70H	SCU 1 Baud	B0H	Refresh Base Addr.	F0H	DMA 3 Source Low
32H	T0 Compare A	72H	SCU 1 Count	B2H	Refresh Time	F2H	DMA 3 Source High
34H	T0 Compare B	74H	SCU 1 Control	B4H	Refresh Control	F4H	DMA 3 Dest. Low
46H	T0 Control	76H	SCU 1 Status	B6H	Refresh Address	F6H	DMA 3 Dest. High
38H	T1 Count	78H	SCU 1 RBUF	B8H	Power Control	F8H	DMA 3 Count
3AH	T1 Compare A	7AH	SCU 1 TBUF	BAH	Reserved	FAH	DMA 3 Control
3CH	T1 Compare B	7CH	Reserved	BCH	Step ID	FCH	Reserved
3EH	T1 Control	7EH	Reserved	BEH	Powersave	FEH	Reserved

Figure 3. Peripheral Control Block Registers

Programmable Interrupt Controllers

The 80C186EC utilizes two 8259A compatible Programmable Interrupt Controllers (PIC) to manage both internal and external interrupts. The 8259A modules are configured in a master/slave arrangement.

Seven of the external interrupt pins, INT0 through INT6, are connected to the master 8259A module. The eighth external interrupt pin, INT7, is connected to the slave 8259A module.

There are a total of 11 internal interrupt sources from the integrated peripherals: 4 Serial, 4 DMA and 3 Timer/Counter.

Timer/Counter Unit

The 80C186EC Timer/Counter Unit (TCU) provides three 16-bit programmable timers. Two of these are highly flexible and are connected to external pins for external control or clocking. The third timer is not connected to any external pins and can only be clocked internally. However, it can be used to clock the other two timer channels. The TCU can be used to count external events, time external events, generate non-repetitive waveforms or generate timed interrupts.

Serial Communications Unit

The 80C186EC Serial Communications Unit (SCU) contains two independent channels. Each channel is identical in operation except that only channel 0 is directly supported by the integrated interrupt controller (the channel 1 interrupts are routed to external interrupt pins). Each channel has its own baud rate generator and can be internally or externally clocked up to one half the processor operating frequency. Both serial channels can request service from the DMA unit thus providing block reception and transmission without CPU intervention.

Independent baud rate generators are provided for each of the serial channels. For the asynchronous modes, the generator supplies an 8x baud clock to both the receive and transmit shifting register logic. A 1x baud clock is provided in the synchronous mode.

DMA Unit

The four channel Direct Memory Access (DMA) Unit is comprised of two modules with two channels each. All four channels are identical in operation. DMA transfers can take place from memory to memory, I/O to memory, memory to I/O or I/O to I/O.

DMA requests can be external (on the DRQ pins), internal (from Timer 2 or a serial channel) or software initiated.

The DMA Unit transfers data as bytes only. Each data transfer requires at least two bus cycles, one to fetch data and one to deposit. The minimum clock count for each transfer is 8, but this will vary depending on synchronization and wait states.

Chip-Select Unit

The 80C186EC Chip-Select Unit (CSU) integrates logic which provides up to ten programmable chip-selects to access both memories and peripherals. In addition, each chip-select can be programmed to automatically insert additional clocks (wait states) into the current bus cycle, and/or automatically terminate a bus cycle independent of the condition of the READY input pin.

I/O Port Unit

The I/O Port Unit on the 80C186EC supports two 8-bit channels and one 6-bit channel of input, output or input/output operation. Port 1 is multiplexed with the chip select pins and is output only. Port 2 is multiplexed with the pins for serial channels 1 and 2. All Port 2 pins are input/output. Port 3 has a total of 6 pins: four that are multiplexed with DMA and serial port interrupts and two that are non-multiplexed, open drain I/O.

Refresh Control Unit

The Refresh Control Unit (RCU) automatically generates a periodic memory read bus cycle to keep dynamic or pseudo-static memory refreshed. A 9-bit counter controls the number of clocks between refresh requests.

A 12-bit address generator is maintained by the RCU and is presented on the A12:1 address lines during the refresh bus cycle. Address bits A19:13 are programmable to allow the refresh address block to be located on any 8 Kbyte boundary.

Watchdog Timer Unit

The Watchdog Timer Unit (WDT) allows for graceful recovery from unexpected hardware and software upsets. The WDT consists of a 32-bit counter that decrements every clock cycle. If the counter reaches zero before being reset, the WDTOUT pin is

pulled low for four clock cycles. Logically ANDing the WDOUT pin with the power-on reset signal allows the WDT to reset the device in the event of a WDT timeout. If a less drastic method of recovery is desired, WDOUT can be connected directly to NMI or one of the INT input pins. The WDT may also be used as a general purpose timer.

Power Management Unit

The 80C186EC Power Management Unit (PMU) is provided to control the power consumption of the device. The PMU provides four power management modes: Active, Powersave, Idle and Powerdown.

Active Mode indicates that all units on the 80C186EC are operating at $\frac{1}{2}$ the CLKIN frequency.

Idle Mode freezes the clocks of the Execution and Bus units at a logic zero state (all peripherals continue to operate normally).

The Powerdown Mode freezes all internal clocks at a logic zero level and disables the crystal oscillator.

In Powersave Mode, all internal clock signals are divided by a programmable prescaler (up to $\frac{1}{64}$ the normal frequency). Powersave Mode can be used with Idle Mode as well as during normal (Active Mode) operation.

80C187 Interface (80C186EC only)

The 80C186EC supports the direct connection of the 80C187 Numerics Processor Extension. The 80C187 can dramatically improve the performance of calculation intensive applications.

ONCE Test Mode

To facilitate testing and inspection of devices when fixed into a target system, the 80C186EC has a test mode available which forces all output and input/output pins to be placed in the high-impedance state. ONCE stands for "ON Circuit Emulation". The ONCE mode is selected by forcing the A19/S6/ONCE pin low during a processor reset (this pin is weakly held high during reset to prevent inadvertent entrance into ONCE Mode).

PACKAGE INFORMATION

This section describes the pin functions, pinout and thermal characteristics for the 80C186EC in the Plastic Quad Flat Pack (JEDEC PQFP), the EIAJ Quad Flat Pack (QFP) and the Shrink Quad Flat Pack (SQFP). For complete package specifications

and information, see the Intel Packaging Outlines and Dimensions Guide (Order Number: 231369).

Prefix Identification

Table 1 lists the prefix identifications.

Table 1. Prefix Identification

Prefix	Note	Package Type	Temperature Range
TS		QFP (EIAJ)	Extended
KU	1	PQFP	Extended/Commercial
SB	1	SQFP	Extended/Commercial
S	1	QFP (EIAJ)	Commercial

NOTE:

- The 5V 25 MHz version is only available in commercial temperature range corresponding to 0°C to +70°C ambient.

Pin Descriptions

Each pin or logical set of pins is described in Table 2. There are four columns for each entry in the Pin Description Table. The following sections describe each column.

Column 1: Pin Name

In this column is a mnemonic that describes the pin function. Negation of the signal name (i.e. RESIN) implies that the signal is active low.

Column 2: Pin Type

A pin may be either power (P), ground (G), input only (I), output only (O) or input/output (I/O). Please note that some pins have more than 1 function. A19/S6/ONCE, for example, is normally an output but functions as an input during reset. For this reason A19/S6/ONCE is classified as an input/output pin.

Column 3: Input Type (for I and I/O types only)

There are two different types of input pins on the 80C186EC: asynchronous and synchronous. **Asynchronous** pins require that setup and hold times be met only to *guarantee recognition*. **Synchronous** input pins require that the setup and hold times be met to *guarantee proper operation*. Stated simply, missing a setup or hold on an asynchronous pin will result in something minor (i.e. a timer count will be missed) whereas missing a setup or hold on a synchronous pin will result in system failure (the system will "lock up").

An input pin may also be edge or level sensitive.

Column 4: Output States (for O and I/O types only)

The state of an output or I/O pin is dependent on the operating mode of the device. There are four modes of operation that are different from normal active mode: Bus Hold, Reset, Idle Mode, Powerdown Mode. This column describes the output pin state in each of these modes.

The legend for interpreting the information in the Pin Descriptions is shown in Table 1.

As an example, please refer to the table entry for AD12:0. The "I/O" signifies that the pins are bidirectional (i.e. have both an input and output function). The "S" indicates that, as an input the signal must be synchronized to CLKOUT for proper operation. The "H(Z)" indicates that these pins will float while

the processor is in the Hold Acknowledge state. R(Z) indicates that these pins will float while RESIN is low. P(0) and I(0) indicate that these pins will drive 0 when the device is in either Powerdown or Idle Mode.

Some pins, the I/O Ports for example, can be programmed to perform more than one function. Multi-function pins have a "/" in their signal name between the different functions (i.e. P3.0/RX11). If the input pin type or output pin state differ between functions, then that will be indicated by separating the state (or type) with a "/" (i.e. H(X)/H(Q)). In this example when the pin is configured as P3.0 then its hold output state is H(X); when configured as RX11 its output state is H(Q).

All pins float while the processor is in the ONCE Mode (with the exception of OSCOUT).



Table 1. Pin Description Nomenclature

Symbol	Description
P	Power Pin (apply + V _{CC} voltage)
G	Ground (connect to V _{SS})
I	Input only pin
O	Output only pin
I/O	Input/Output pin
S(E)	Synchronous, edge sensitive
S(L)	Synchronous, level sensitive
A(E)	Asynchronous, edge sensitive
A(L)	Asynchronous, level sensitive
H(1)	Output driven to V _{CC} during bus hold
H(0)	Output driven to V _{SS} during bus hold
H(Z)	Output floats during bus hold
H(Q)	Output remains active during bus hold
H(X)	Output retains current state during bus hold
R(WH)	Output weakly held at V _{CC} during reset
R(1)	Output driven to V _{CC} during reset
R(0)	Output driven to V _{SS} during reset
R(Z)	Output floats during reset
R(Q)	Output remains active during reset
R(X)	Output retains current state during reset
I(1)	Output driven to V _{CC} during Idle Mode
I(0)	Output driven to V _{SS} during Idle Mode
I(Z)	Output floats during Idle Mode
I(Q)	Output remains active during Idle Mode
I(X)	Output retains current state during Idle Mode
P(1)	Output driven to V _{CC} during Powerdown Mode
P(0)	Output driven to V _{SS} during Powerdown Mode
P(Z)	Output floats during Powerdown Mode
P(Q)	Output remains active during Powerdown Mode
P(X)	Output retains current state during Powerdown Mode

Table 2. Pin Descriptions

Pin Name	Pin Type	Input Type	Output States	Pin Description
V _{CC}	P	—	—	POWER +5V ± 10% power supply connection
V _{SS}	G	—	—	GROUND
CLKIN	I	A(E)	—	CLock Input is the external clock input. An external oscillator operating at two times the required processor operating frequency can be connected to CLKIN. For crystal operation, CLKIN (along with OSCOUT) are the crystal connections to an internal Pierce oscillator.
OSCOUT	O	—	H(Q) R(Q) I(Q) P(X)	OSCillator OUTPUT is only used when using a crystal to generate the internal clock. OSCOUT (along with CLKIN) are the crystal connections to an internal Pierce oscillator. This pin can not be used as 2X clock output for non-crystal applications (i.e. this pin is not connected for non-crystal applications).
CLKOUT	O	—	H(Q) R(Q) I(Q) P(X)	CLock OUTPUT provides a timing reference for inputs and outputs of the processor, and is one-half the input clock (CLKIN) frequency. CLKOUT has a 50% duty cycle and transitions every falling edge of CLKIN.
RESIN	I	A(L)	—	RESet IN causes the processor to immediately terminate any bus cycle in progress and assume an initialized state. All pins will be driven to a known state, and RESOUT will also be driven active. The rising edge (low-to-high) transition synchronizes CLKOUT with CLKIN before the processor begins fetching opcodes at memory location 0FFFF0H.
RESOUT	O	—	H(0) R(1) I(0) P(0)	RESet OUTPUT that indicates the processor is currently in the reset state. RESOUT will remain active as long as RESIN remains active.
PDTMR	I/O	A(L)	H(WH) R(Z) P(WH) I(WH)	Power-Down TiMeR pin (normally connected to an external capacitor) that determines the amount of time the processors waits after an exit from Powerdown before resuming normal operation. The duration of time required will depend on the startup characteristics of the crystal oscillator.
NMI	I	A(E)	—	Non-Maskable Interrupt input causes a TYPE-2 interrupt to be serviced by the CPU. NMI is latched internally.
TEST/BUSY (TEST)	I	A(E)	—	TEST is used during the execution of the WAIT instruction to suspend CPU operation until the pin is sampled active (LOW). TEST is alternately known as BUSY when interfacing with an 80C187 numerics coprocessor (80C186EC only).
A19/S6/ONCE	I/O	A(L)	H(Z) R(WH) I(0) P(0)	This pin drives address bit 19 during the address phase of the bus cycle. During T2 and T3 this pin functions as status bit 6. S6 is low to indicate CPU bus cycles and high to indicate DMA or refresh bus cycles. During a processor reset (RESIN active) this pin becomes the ONCE input pin. Holding this pin low during reset will force the part into ONCE Mode.

NOTE:

Pin names in parentheses apply to the 80C188EC/80L188EC.

Table 2. Pin Descriptions (Continued)

Pin Name	Pin Type	Input Type	Output States	Pin Description																																				
A18/S5 A17/S4 A16/S3 (A15:8)	I/O	A(L)	H(Z) R(WH) I(0) P(0)	These pins drive address information during the address phase of the bus cycle. During T2 and T3 these pins drive status information (which is always 0 on the 80C186EC). These pins are used as inputs during factory test; driving these pins low during reset will cause unspecified operation. On the 80C188EC, A15:8 provide valid address information for the entire bus cycle.																																				
AD15/CAS2 AD14/CAS1 AD13/CAS0	I/O	S(L)	H(Z) R(Z) I(0) P(0)	These pins are part of the multiplexed ADDRESS and DATA bus. During the address phase of the bus cycle, address bits 15 through 13 are presented on these pins and can be latched using ALE. Data information is transferred during the data phase of the bus cycle. Pins AD15:13/CAS2:0 drive the 82C59 slave address information during interrupt acknowledge cycles.																																				
AD12:0 (AD7:0)	I/O	S(L)	H(Z) R(Z) I(0) P(0)	These pins provide a multiplexed ADDRESS and DATA bus. During the address phase of the bus cycle, address bits 0 through 12 (0 through 7 on the 80C188EC) are presented on the bus and can be latched using ALE. Data information is transferred during the data phase of the bus cycle.																																				
$\overline{S2:0}$	O	—	H(Z) R(1) I(1) P(1)	Bus cycle Status are encoded on these pins to provide bus transaction information. $\overline{S2:0}$ are encoded as follows:																																				
				<table border="1"> <thead> <tr> <th>$\overline{S2}$</th> <th>$\overline{S1}$</th> <th>$\overline{S0}$</th> <th>Bus Cycle Initiated</th> </tr> </thead> <tbody> <tr> <td>0</td> <td>0</td> <td>0</td> <td>Interrupt Acknowledge</td> </tr> <tr> <td>0</td> <td>0</td> <td>1</td> <td>Read I/O</td> </tr> <tr> <td>0</td> <td>1</td> <td>0</td> <td>Write I/O</td> </tr> <tr> <td>0</td> <td>1</td> <td>1</td> <td>Processor HALT</td> </tr> <tr> <td>1</td> <td>0</td> <td>0</td> <td>Instruction Queue Fetch</td> </tr> <tr> <td>1</td> <td>0</td> <td>1</td> <td>Read Memory</td> </tr> <tr> <td>1</td> <td>1</td> <td>0</td> <td>Write Memory</td> </tr> <tr> <td>1</td> <td>1</td> <td>1</td> <td>Passive (No bus activity)</td> </tr> </tbody> </table>	$\overline{S2}$	$\overline{S1}$	$\overline{S0}$	Bus Cycle Initiated	0	0	0	Interrupt Acknowledge	0	0	1	Read I/O	0	1	0	Write I/O	0	1	1	Processor HALT	1	0	0	Instruction Queue Fetch	1	0	1	Read Memory	1	1	0	Write Memory	1	1	1	Passive (No bus activity)
$\overline{S2}$	$\overline{S1}$	$\overline{S0}$	Bus Cycle Initiated																																					
0	0	0	Interrupt Acknowledge																																					
0	0	1	Read I/O																																					
0	1	0	Write I/O																																					
0	1	1	Processor HALT																																					
1	0	0	Instruction Queue Fetch																																					
1	0	1	Read Memory																																					
1	1	0	Write Memory																																					
1	1	1	Passive (No bus activity)																																					
ALE	O	—	H(0) R(0) I(0) P(0)	Address Latch Enable output is used to strobe address information into a transparent type latch during the address phase of the bus cycle.																																				
BHE (RFSH)	O	—	H(Z) R(Z) I(1) P(1)	Byte High Enable output to indicate that the bus cycle in progress is transferring data over the upper half of the data bus. BHE and A0 have the following logical encoding:																																				
				<table border="1"> <thead> <tr> <th>A0</th> <th>BHE</th> <th>Encoding (for 80C186EC/ 80L186EC only)</th> </tr> </thead> <tbody> <tr> <td>0</td> <td>0</td> <td>Word transfer</td> </tr> <tr> <td>0</td> <td>1</td> <td>Even Byte transfer</td> </tr> <tr> <td>1</td> <td>0</td> <td>Odd Byte transfer</td> </tr> <tr> <td>1</td> <td>1</td> <td>Refresh operation</td> </tr> </tbody> </table>	A0	BHE	Encoding (for 80C186EC/ 80L186EC only)	0	0	Word transfer	0	1	Even Byte transfer	1	0	Odd Byte transfer	1	1	Refresh operation																					
A0	BHE	Encoding (for 80C186EC/ 80L186EC only)																																						
0	0	Word transfer																																						
0	1	Even Byte transfer																																						
1	0	Odd Byte transfer																																						
1	1	Refresh operation																																						
On the 80C188EC/80L188EC, \overline{RFSH} is asserted low to indicate a refresh bus cycle.																																								

1

NOTE:

Pin names in parentheses apply to the 80C188EC/80L188EC.

PRELIMINARY

4826175 0162058 04T

Table 2. Pin Descriptions (Continued)

Pin Name	Pin Type	Input Type	Output States	Pin Description
\overline{RD}	O	—	H(Z) R(Z) I(1) P(1)	Read output signals that the accessed memory or I/O device should drive data information onto the data bus.
\overline{WR}	O	—	H(Z) R(Z) I(1) P(1)	Write output signals that data available on the data bus are to be written into the accessed memory or I/O device.
READY	I	A(L) S(L) (Note 1)	—	READY input to signal the completion of a bus cycle. READY must be active to terminate any 80C186EC bus cycle, unless it is ignored by correctly programming the Chip-Select unit.
\overline{DEN}	O	—	H(Z) R(Z) I(1) P(1)	Data Enable output to control the enable of bi-directional transceivers in a buffered system. \overline{DEN} is active only when data is to be transferred on the bus.
DT/\overline{R}	O	—	H(Z) R(Z) I(X) P(X)	Data Transmit/Receive output controls the direction of a bi-directional buffer in a buffered system.
\overline{LOCK}	I/O	A(L)	H(Z) R(Z) I(X) P(X)	LOCK output indicates that the bus cycle in progress is not interruptable. The processor will not service other bus requests (such as \overline{HOLD}) while \overline{LOCK} is active. This pin is configured as a weakly held high input while \overline{RESIN} is active and must not be driven low.
\overline{HOLD}	I	A(L)	—	HOLD request input to signal that an external bus master wishes to gain control of the local bus. The processor will relinquish control of the local bus between instruction boundaries that are not \overline{LOCK} ed.
HLDA	O	—	H(1) R(0) I(0) P(0)	Hold Acknowledge output to indicate that the processor has relinquished control of the local bus. When HLDA is asserted, the processor will (or has) floated its data bus and control signals allowing another bus master to drive the signals directly.
\overline{NCS}	O	—	H(1) R(1) I(1) P(1)	Numerics Coprocessor Select output is generated when accessing a numerics coprocessor. This signal does not exist on the 80C188EC/80L188EC.
\overline{ERROR}	I	A(L)	—	ERROR input that indicates the last numerics processor extension operation resulted in an exception condition. An interrupt TYPE 16 is generated if \overline{ERROR} is sampled active at the beginning of a numerics operation. Systems not using an 80C187 must tie \overline{ERROR} to V_{CC} . This signal does not exist on the 80C188EC/80L188EC.

NOTE:

Pin names in parentheses apply to the 80C188EC/80L188EC.

Table 2. Pin Descriptions (Continued)

Pin Name	Pin Type	Input Type	Output States	Pin Description
PEREQ	I	A(L)	—	Processor Extension REQuest signals that a data transfer between an 80C187 Numerics Processor Extension and Memory is pending. Systems not using an 80C187 must tie this pin to V _{SS} . This signal does not exist on the 80C188EC/80L188EC.
UCS	O	—	H(1) R(1) I(1) P(1)	Upper Chip Select will go active whenever the address of a memory or I/O bus cycle is within the address range programmed by the user. After reset, UCS is configured to be active for memory accesses between 0FFC00H and 0FFFFH.
LCS	O	—	H(1) R(1) I(1) P(1)	Lower Chip Select will go active whenever the address of a memory or I/O bus cycle is within the address range programmed by the user. LCS is inactive after a reset.
P1.0/GCS0 P1.1/GCS1 P1.2/GCS2 P1.3/GCS3 P1.4/GCS4 P1.5/GCS5 P1.6/GCS6 P1.7/GCS7	O	—	H(X)/H(1) R(1) I(X)/I(1) P(X)/P(1)	These pins provide a multiplexed function. If enabled, each pin can provide a General purpose Chip Select output which will go active whenever the address of a memory or I/O bus cycle is within the address limitations programmed by the user. When not programmed as a Chip-Select, each pin may be used as a general purpose output port.
T0OUT T1OUT	O	—	H(Q) R(1) I(Q) P(X)	Timer OUTput pins can be programmed to provide single clock or continuous waveform generation, depending on the timer mode selected.
T0IN T1IN	I	A(L) A(E)	—	Timer INput is used either as clock or control signals, depending on the timer mode selected. This pin may be either level or edge sensitive depending on the programming mode.
INT7:0	I	A(L) A(E)	—	Maskable INTerrupt input will cause a vector to a specific Type interrupt routine. The INT6:0 pins can be used as cascade inputs from slave 8259A devices. The INT pins can be configured as level or edge sensitive.
INTA	O	—	H(1) R(1) I(1) P(1)	INTerrupt Acknowledge output is a handshaking signal used by external 82C59A Programmable Interrupt Controllers.
P3.5 P3.4	I/O	A(L)	H(X) R(Z) I(X) H(X)	Bidirectional, open-drain port pins.
P3.3/DMAI1 P3.2/DMAI0	O	—	H(X) R(0) I(Q) P(X)	DMA Interrupt output goes active to indicate that the channel has completed a transfer. DMAI1 and DMAI0 are multiplexed with output only port functions.

NOTE:

Pin names in parentheses apply to the 80C188EC/80L188EC.

Table 2. Pin Descriptions (Continued)

Pin Name	Pin Type	Input Type	Output States	Pin Description
P3.1/TX11	O	—	H(X)/H(Q) R(0) I(Q) P(X)	Transmit Interrupt output goes active to indicate that serial channel 1 has completed a transfer. TX11 is multiplexed with an output only Port function.
P3.0/RX11	O	—	H(X)/H(Q) R(0) I(Q) P(X)	Receive Interrupt output goes active to indicate that serial channel 1 has completed a reception. RX11 is multiplexed with an output only port function.
WDTOUT	O	—	H(Q) R(1) I(Q) P(X)	WatchDog Timer OUTput is driven low for four clock cycles when the watchdog timer reaches zero. WDTOUT may be ANDed with the power-on reset signal to reset the processor when the watchdog timer is not properly reset.
P2.7/ $\overline{\text{CTS1}}$ P2.3/ $\overline{\text{CTS0}}$	I/O	A(L)	H(X) R(Z) I(X) P(X)	Clear-To-Send input is used to prevent the transmission of serial data on the TXD signal pin. $\overline{\text{CTS1}}$ and $\overline{\text{CTS0}}$ are multiplexed with an I/O Port function.
P2.6/BCLK1 P2.2/BCLK0	I/O	A(L)/ A(E)	H(X) R(Z) I(X) P(X)	Baud Clock input can be used as an alternate clock source for each of the integrated serial channels. The BCLK inputs are multiplexed with I/O Port functions. The BCLK input frequency cannot exceed $\frac{1}{2}$ the operating frequency of the processor.
P2.5/TXD1 P2.1/TXD0	I/O	A(L)	H(Q) R(Z) I(X)/I(Q) P(X)	Transmit Data output provides serial data information. The TXD outputs are multiplexed with I/O Port functions. During synchronous serial communications, TXD will function as a clock output.
P2.4/RXD1 P2.0/RXD0	I/O	A(L)	H(X)/H(Q) R(Z) I(X)/I(Q) P(X)	Receive Data input accepts serial data information. The RXD pins are multiplexed with I/O Port functions. During synchronous serial communications, RXD is bi-directional and will become an output for transmission of data (TXD becomes the clock).
DRQ3:0	I	A(L)	—	DMA ReQuest input pins are used to request a DMA transfer. The timing of the request is dependent on the programmed synchronization mode.

NOTES:

1. READY is A(E) for the rising edge of CLKOUT, S(E) for the falling edge of CLKOUT.
2. Pin names in parentheses apply to the 80C188EC/80L188EC.

Pinout

Tables 3 and 4 list the pin names with package location for the 100-pin Plastic Quad Flat Pack (PQFP) component. Figure 4 depicts the PQFP package as viewed from the top side of the component (i.e. contacts facing down).

Tables 5 and 6 list the pin names with package location for the 100-pin EIAJ Quad Flat Pack (QFP) component. Figure 5 depicts the QFP package as viewed

from the top side of the component (i.e. contacts facing down).

Tables 7 and 8 list the pin names with package location for the 100-pin Shrink Quad Flat Pack (SQFP) component. Figure 6 depicts the SQFP package as viewed from the top side of the component (i.e., contacts facing down).

Table 3. PQFP Pin Functions with Location

AD Bus		Bus Control		Processor Control		I/O	
Name	Pin	Name	Pin	Name	Pin	Name	Pin
AD0	73	ALE	52	RESIN	8	UCS	88
AD1	72	BHE ($\overline{\text{RFSH}}$)	51	RESOUT	7	LCS	89
AD2	71	S0	78	CLKIN	10	P1.7/ $\overline{\text{GCS7}}$	90
AD3	70	S1	79	OSCOU	11	P1.6/ $\overline{\text{GCS6}}$	91
AD4	66	S2	80	CLKOUT	6	P1.5/ $\overline{\text{GCS5}}$	92
AD5	65	RD	50	TEST/BUSY	83	P1.4/ $\overline{\text{GCS4}}$	93
AD6	64	WR	49	(TEST)		P1.3/ $\overline{\text{GCS3}}$	94
AD7	63	READY	85	PEREQ (V_{SS})	81	P1.2/ $\overline{\text{GCS2}}$	95
AD8 (A8)	60	DN	47	NCS (N.C.)	35	P1.1/ $\overline{\text{GCS1}}$	96
AD9 (A9)	59	DT/ $\overline{\text{R}}$	46	ERROR (V_{CC})	84	P1.0/ $\overline{\text{GCS0}}$	97
AD10 (A10)	58	LOCK	48	PDTMR	9		
AD11 (A11)	57	HOLD	44	NMI	82	P2.7/ $\overline{\text{CTS1}}$	23
AD12 (A12)	56	HLDA	45	INT0	30	P2.6/ $\overline{\text{BCLK1}}$	22
AD13/CAS0	55	INTA	34	INT1	31	P2.5/TXD1	21
(A13/CAS0)				INT2	32	P2.4/RXD1	20
AD14/CAS1	54			INT3	33	P2.3/ $\overline{\text{CTS0}}$	19
(A14/CAS1)				INT4	40	P2.2/ $\overline{\text{BCLK0}}$	18
AD15/CAS2	53			INT5	41	P2.1/TXD0	17
(A15/CAS2)				INT6	42	P2.0/RXD0	16
A16/S3	77			INT7	43		
A17/S4	76					P3.5	29
A18/S5	75					P3.4	28
A19/S6/ $\overline{\text{ONCE}}$	74					P3.3/DMA11	27
						P3.2/DMA10	26
						P3.1/TX11	25
						P3.0/RX11	24
						T0IN	3
						T0OUT	2
						T1IN	5
						T1OUT	4
						DRQ0	98
						DRQ1	99
						DRQ2	100
						DRQ3	1
						$\overline{\text{WDTOUT}}$	36

1

Table 4. PQFP Pin Locations with Pin Name

Pin	Name	Pin	Name	Pin	Name	Pin	Name
1	DRQ3	26	DMAI0/P3.2	51	$\overline{\text{BHE}}$ (RFSH)	76	A17/S4
2	TOOUT	27	DMAI1/P3.3	52	ALE	77	A16/S3
3	TOIN	28	P3.4	53	AD15 (A15)	78	$\overline{\text{S0}}$
4	T1OUT	29	P3.5	54	AD14 (A14)	79	$\overline{\text{S1}}$
5	T1IN	30	INT0	55	AD13 (A13)	80	$\overline{\text{S2}}$
6	CLKOUT	31	INT1	56	AD12 (A12)	81	PEREQ (V _{SS})
7	RESOUT	32	INT2	57	AD11 (A11)	82	NMI
8	$\overline{\text{RESIN}}$	33	INT3	58	AD10 (A10)	83	$\overline{\text{TEST}}$
9	PDTMR	34	$\overline{\text{INTA}}$	59	AD9 (A9)	84	$\overline{\text{ERROR}}$ (V _{CC})
10	CLKIN	35	$\overline{\text{NCS}}$ (N.C.)	60	AD8 (A8)	85	READY
11	OSCOOUT	36	$\overline{\text{WDTOUT}}$	61	V _{SS}	86	V _{CC}
12	V _{SS}	37	V _{SS}	62	V _{CC}	87	V _{SS}
13	V _{CC}	38	V _{CC}	63	AD7	88	$\overline{\text{UCS}}$
14	V _{CC}	39	V _{SS}	64	AD6	89	$\overline{\text{LCS}}$
15	V _{SS}	40	INT4	65	AD5	90	P1.7/ $\overline{\text{GCS7}}$
16	P2.0/RXD0	41	INT5	66	AD4	91	P1.6/ $\overline{\text{GCS6}}$
17	P2.1/TXD0	42	INT6	67	V _{CC}	92	P1.5/ $\overline{\text{GCS5}}$
18	P2.2/BCLK0	43	INT7	68	V _{SS}	93	P1.4/ $\overline{\text{GCS4}}$
19	P2.3/ $\overline{\text{CTS0}}$	44	HOLD	69	V _{CC}	94	P1.3/ $\overline{\text{GCS3}}$
20	P2.4/RXD1	45	HLDA	70	AD3	95	P1.2/ $\overline{\text{GCS2}}$
21	P2.5/TXD1	46	DT/ $\overline{\text{R}}$	71	AD2	96	P1.1/ $\overline{\text{GCS1}}$
22	P2.6/BCLK1	47	$\overline{\text{DEN}}$	72	AD1	97	P1.0/ $\overline{\text{GCS0}}$
23	P2.7/ $\overline{\text{CTS1}}$	48	$\overline{\text{LOCK}}$	73	AD0	98	DRQ0
24	P3.0/RX11	49	$\overline{\text{WR}}$	74	A19/S6/ $\overline{\text{ONCE}}$	99	DRQ1
25	P3.1/TX11	50	$\overline{\text{RD}}$	75	A18/S5	100	DRQ2

1

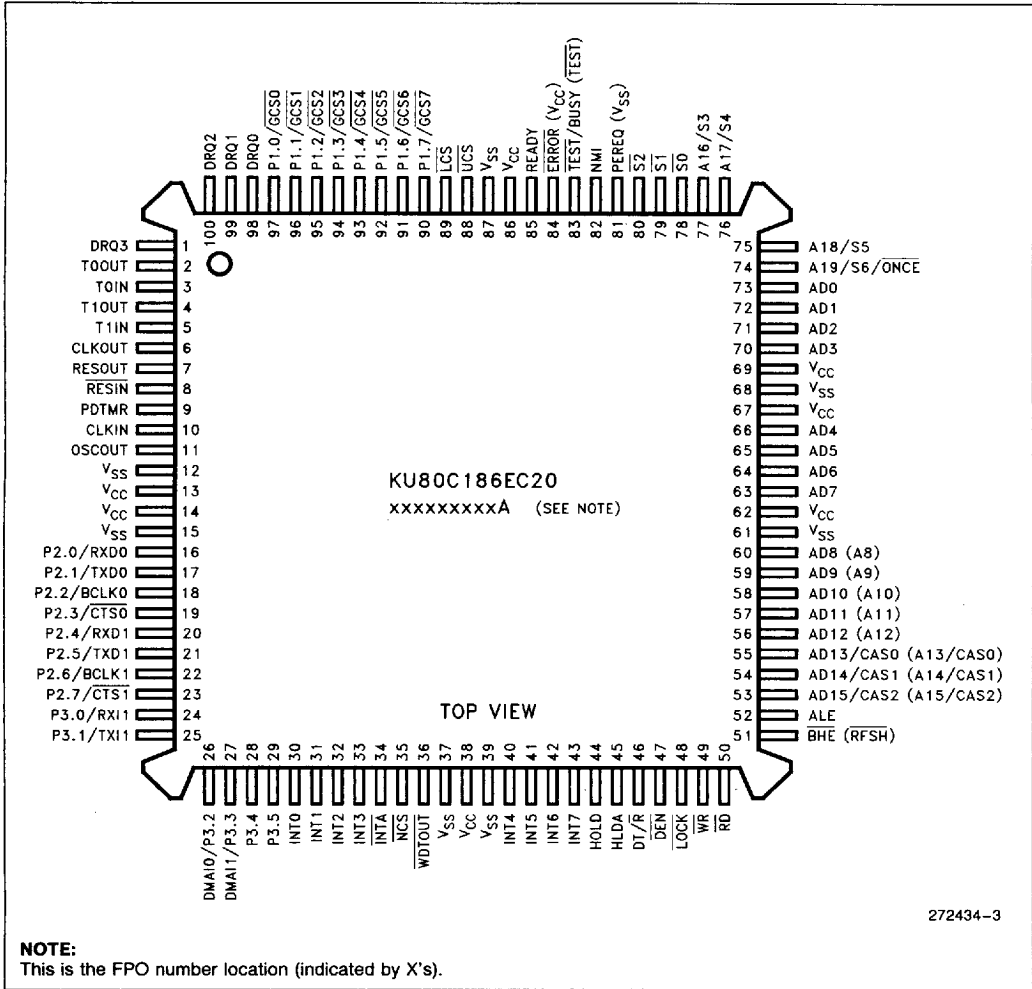

Figure 4. 100-Pin Plastic Quad Flat Pack Package (PQFP)

Table 5. QFP Pin Names with Package Location

AD Bus		Bus Control		Processor Control		I/O	
Name	Pin	Name	Pin	Name	Pin	Name	Pin
AD0	76	ALE	55	RESIN	11	UCS	91
AD1	75	BHE ($\overline{\text{RFSH}}$)	54	RESOUT	10	LCS	92
AD2	74	$\overline{\text{S0}}$	81	CLKIN	13	P1.7/ $\overline{\text{GCS7}}$	93
AD3	73	$\overline{\text{S1}}$	82	OSCOU	14	P1.6/ $\overline{\text{GCS6}}$	94
AD4	69	$\overline{\text{S2}}$	83	CLKOUT	9	P1.5/ $\overline{\text{GCS5}}$	95
AD5	68	$\overline{\text{RD}}$	53	TEST/BUSY	86	P1.4/ $\overline{\text{GCS4}}$	96
AD6	67	WR	52	(TEST)		P1.3/ $\overline{\text{GCS3}}$	97
AD7	66	READY	88	PEREQ (V_{SS})	84	P1.2/ $\overline{\text{GCS2}}$	98
AD8 (A8)	63	DEN	50	NCS (N.C.)	38	P1.1/ $\overline{\text{GCS1}}$	99
AD9 (A9)	62	DT/ $\overline{\text{R}}$	49	ERROR (V_{CC})	87	P1.0/ $\overline{\text{GCS0}}$	100
AD10 (A10)	61	LOCK	51	PDTMR	12		
AD11 (A11)	60	HOLD	47	NMI	85	P2.7/ $\overline{\text{CTS1}}$	26
AD12 (A12)	59	HLDA	48	INT0	33	P2.6/BCLK1	25
AD13/CAS0 (A13/CAS0)	58	INTA	37	INT1	34	P2.5/TXD1	24
AD14/CAS1 (A14/CAS1)	57			INT2	35	P2.4/RXD1	23
AD15/CAS2 (A15/CAS2)	56			INT3	36	P2.3/ $\overline{\text{CTS0}}$	22
A16/S3	80			INT4	43	P2.2/BCLK0	21
A17/S4	79			INT5	44	P2.1/TXD0	20
A18/S5	78			INT6	45	P2.0/RXD0	19
A19/S6/ $\overline{\text{ONCE}}$	77			INT7	46		
						P3.5	32
						P3.4	31
						P3.3/DMAI1	30
						P3.2/DMAI0	29
						P3.1/TXI1	28
						P3.0/RXI1	27
						T0IN	6
						T0OUT	5
						T1IN	8
						T1OUT	7
						DRQ0	1
						DRQ1	2
						DRQ2	3
						DRQ3	4
						$\overline{\text{WDTOUT}}$	39

Table 6. QFP Package Location with Pin Names

Pin	Name	Pin	Name	Pin	Name	Pin	Name
1	DRQ0	26	P2.7/CTS1	51	LOCK	76	AD0
2	DRQ1	27	P3.0/RX11	52	WR	77	A19/S6/ONCE
3	DRQ2	28	P3.1/TX11	53	RD	78	A18/S5
4	DRQ3	29	DMA10/P3.2	54	BHE (RFSH)	79	A17/S4
5	T0OUT	30	DMA11/P3.3	55	ALE	80	A16/S3
6	T0IN	31	P3.4	56	AD15 (A15)	81	S0
7	T1OUT	32	P3.5	57	AD14 (A14)	82	S1
8	T1IN	33	INT0	58	AD13 (A13)	83	S2
9	CLKOUT	34	INT1	59	AD12 (A12)	84	PEREQ (V _{SS})
10	RESOUT	35	INT2	60	AD11 (A11)	85	NMI
11	RESIN	36	INT3	61	AD10 (A10)	86	TEST
12	PDTMR	37	INTA	62	AD9 (A9)	87	ERROR (V _{CC})
13	CLKIN	38	NCS (N.C.)	63	AD8 (A8)	88	READY
14	OSCOUT	39	WDTOUT	64	V _{SS}	89	V _{CC}
15	V _{SS}	40	V _{SS}	65	V _{CC}	90	V _{SS}
16	V _{CC}	41	V _{CC}	66	AD7	91	UCS
17	V _{CC}	42	V _{SS}	67	AD6	92	LCS
18	V _{SS}	43	INT4	68	AD5	93	P1.7/GCS7
19	P2.0/RXD0	44	INT5	69	AD4	94	P1.6/GCS6
20	P2.1/TXD0	45	INT6	70	V _{CC}	95	P1.5/GCS5
21	P2.2/BCLK0	46	INT7	71	V _{SS}	96	P1.4/GCS4
22	P2.3/CTS0	47	HOLD	72	V _{CC}	97	P1.3/GCS3
23	P2.4/RXD1	48	HLDA	73	AD3	98	P1.2/GCS2
24	P2.5/TXD1	49	DT/R	74	AD2	99	P1.1/GCS1
25	P2.6/BCLK1	50	DEN	75	AD1	100	P1.0/GCS0

1

Table 8. SQFP Pin Locations with Pin Names

Pin	Name	Pin	Name	Pin	Name	Pin	Name
1	DRQ3	26	P3.2/DMAI0	51	BHE (RFSH)	76	A17
2	T0OUT	27	P3.3/DMAI1	52	ALE	77	A16
3	T0IN	28	P3.4	53	AD15 (A15)	78	$\overline{S0}$
4	T1OUT	29	P3.5	54	AD14 (A14)	79	$\overline{S1}$
5	T1IN	30	INT0	55	AD13 (A13)	80	$\overline{S2}$
6	CLKOUT	31	INT1	56	AD12 (A12)	81	PEREQ (V _{SS})
7	RESOUT	32	INT2	57	AD11 (A11)	82	MNI
8	RESIN	33	INT3	58	AD10 (A10)	83	$\overline{\text{TEST/BUSY}}$ (TEST)
9	PDTMR	34	$\overline{\text{INTA}}$	59	AD9 (A9)	84	$\overline{\text{ERROR}}$ (V _{CC})
10	CLKIN	35	$\overline{\text{NSC}}$ (N.C.)	60	AD8 (A8)	85	READY
11	OSCOU	36	$\overline{\text{WDTOUT}}$	61	V _{SS}	86	V _{CC}
12	V _{SS}	37	V _{SS}	62	V _{CC}	87	V _{SS}
13	V _{CC}	38	V _{CC}	63	AD7 (A7)	88	UCS
14	V _{CC}	39	V _{SS}	64	AD6 (A6)	89	$\overline{\text{LCS}}$
15	V _{SS}	40	INT4	65	AD5	90	P1.7/ $\overline{\text{GCS7}}$
16	P2.0/RXD0	41	INT5	66	AD4	91	P1.6/ $\overline{\text{GS6}}$
17	P2.1/TXD0	42	INT6	67	V _{CC}	92	P1.5/ $\overline{\text{GCS5}}$
18	P2.2/ $\overline{\text{BCLK0}}$	43	INT7	68	V _{SS}	93	P1.4/ $\overline{\text{GCS4}}$
19	P2.3/ $\overline{\text{CTS0}}$	44	HOLD	69	V _{CC}	94	P1.3/ $\overline{\text{GCS3}}$
20	P2.4/RXD1	45	HLDA	70	AD3	95	P1.2/ $\overline{\text{GCS2}}$
21	P2.5/TXD1	46	DT/ $\overline{\text{R}}$	71	AD2	96	P1.1/ $\overline{\text{GCS1}}$
22	P2.6/ $\overline{\text{BCLK1}}$	47	$\overline{\text{DEN}}$	72	AD1	97	P1.0/ $\overline{\text{GCS0}}$
23	P2.7/ $\overline{\text{CTS1}}$	48	$\overline{\text{LOCK}}$	73	AD0	98	DRQ0
24	P3.0/RX11	49	$\overline{\text{WR}}$	74	A19/ONCE	99	DRQ1
25	P3.1/TX11	50	RD	75	AD18	100	DRQ2

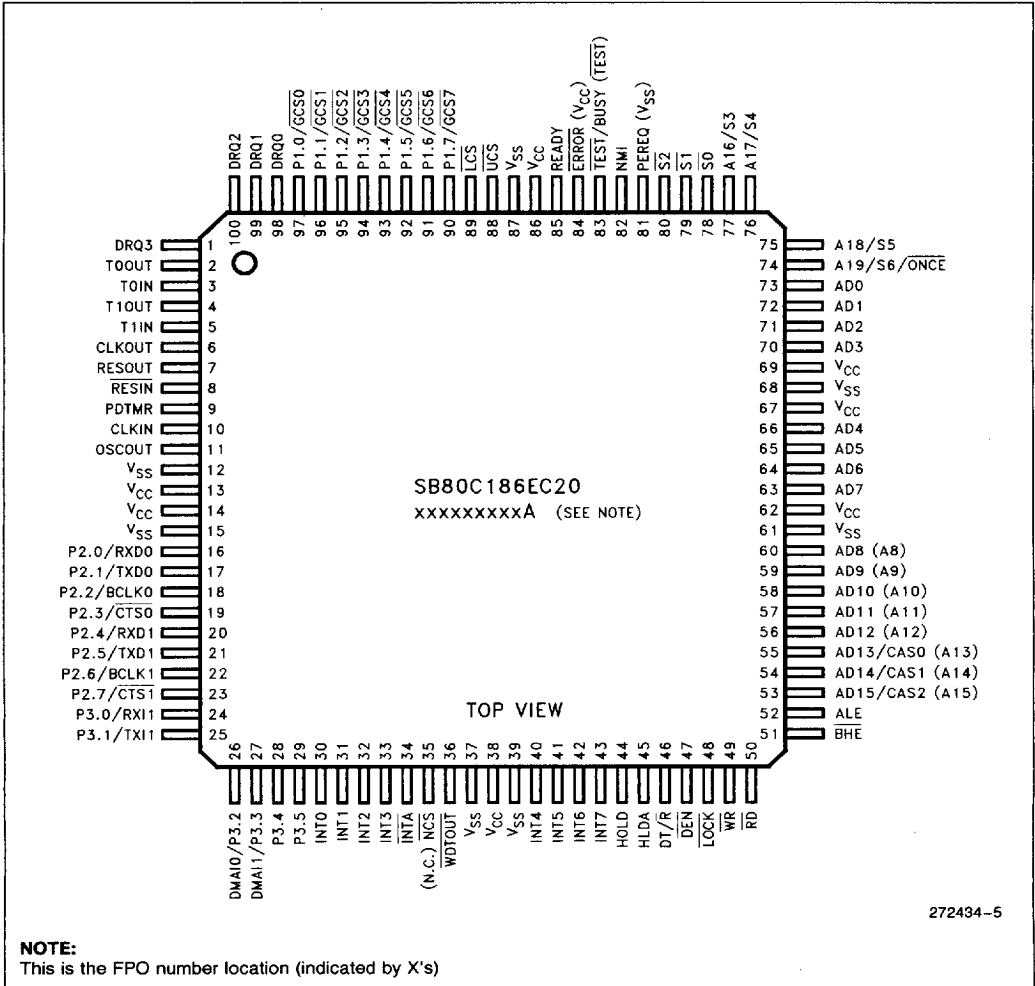

Figure 6. 100-Pin Shrink Quad Flat Pack Package (SQFP)

1

Package Thermal Specifications

The 80C186EC/80L186EC is specified for operation when T_C (the case temperature) is within the range of -40°C to $+100^{\circ}\text{C}$. T_C may be measured in any environment to determine whether the processor is within the specified operating range. The case temperature must be measured at the center of the top surface.

T_A (the ambient temperature) can be calculated from θ_{CA} (thermal resistance from the case to ambient) with the following equation:

$$T_A = T_C - P \cdot \theta_{CA}$$

Typical values for θ_{CA} at various airflows are given in Table 9. P (the maximum power consumption—specified in Watts) is calculated by using the maximum I_{CC} and V_{CC} of 5.5V.

Table 9. Thermal Resistance (θ_{CA}) at Various Airflows (in $^{\circ}\text{C}/\text{Watt}$)

	Airflow in ft/min (m/sec)					
	0 (0)	200 (1.01)	400 (2.03)	600 (3.04)	800 (4.06)	1000 (5.07)
θ_{CA} (PQFP)	27.0	22.0	18.0	15.0	14.0	13.5
θ_{CA} (QFP)	64.5	55.5	51.0	TBD	TBD	TBD
θ_{CA} (SQFP)	62.0	TBD	TBD	TBD	TBD	TBD

ELECTRICAL SPECIFICATIONS

Absolute Maximum Ratings

Storage Temperature -65°C to +150°C
 Case Temperature Under Bias . . . -65°C to +100°C
 Supply Voltage
 with Respect to V_{SS} -0.5V to +6.5V
 Voltage on Other Pins
 with Respect to V_{SS} -0.5V to $V_{CC} + 0.5V$

Recommended Connections

Power and ground connections must be made to multiple V_{CC} and V_{SS} pins. Every 80C186EC-based circuit board should include separate power (V_{CC}) and ground (V_{SS}) planes. Every V_{CC} pin must be connected to the power plane, and every V_{SS} pin must be connected to the ground plane. Liberal decoupling capacitance should be placed near the processor. The processor can cause transient power surges when its output buffers transition, particularly when connected to large capacitive loads.

NOTICE: This data sheet contains preliminary information on new products in production. The specifications are subject to change without notice. Verify with your local Intel Sales office that you have the latest data sheet before finalizing a design.

**WARNING: Stressing the device beyond the "Absolute Maximum Ratings" may cause permanent damage. These are stress ratings only. Operation beyond the "Operating Conditions" is not recommended and extended exposure beyond the "Operating Conditions" may affect device reliability.*

Low inductance capacitors and interconnects are recommended for best high frequency electrical performance. Inductance is reduced by placing the decoupling capacitors as close as possible to the processor V_{CC} and V_{SS} package pins.

Always connect any unused input to an appropriate signal level. In particular, unused interrupt inputs (NMI, INTO:7) should be connected to V_{SS} through a pull-down resistor. Leave any unused output pin unconnected.



DC SPECIFICATIONS (80C186EC/80C188EC)

Symbol	Parameter	Min	Max	Units	Notes
V _{CC}	Supply Voltage	4.5	5.5	V	
V _{IL}	Input Low Voltage	-0.5	0.3 V _{CC}	V	
V _{IH}	Input High Voltage	0.7 V _{CC}	V _{CC} + 0.5	V	
V _{OL}	Output Low Voltage		0.45	V	I _{OL} = 3 mA (Min)
V _{OH}	Output High Voltage	V _{CC} - 0.5		V	I _{OH} = -2 mA (Min)
V _{HYR}	Input Hysteresis on $\overline{\text{RESIN}}$	0.5		V	
I _{LI}	Input Leakage Current for Pins: AD15:0 (AD7:0, A15:8), READY, HOLD, $\overline{\text{RESIN}}$, CLKIN, $\overline{\text{TEST}}$ /BUSY, NMI, INT7:0, TOIN, T1IN, P2.7-P2.0, P3.5-P3.0, DRQ3:0, PEREQ, ERROR		± 15	µA	0 ≤ V _{IN} ≤ V _{CC}
I _{LIU}	Input Leakage for Pins with Pullups Active During Reset: A19:16, LOCK	-0.275	-5	mA	V _{IN} = 0.7 V _{CC} (Note 1)
I _{LO}	Output Leakage for Floated Output Pins		± 15	µA	0.45 ≤ V _{OUT} ≤ V _{CC} (Note 2)
I _{CC}	Supply Current Cold (in RESET) 80C186EC25 80C186EC20 80C186EC13		125 100 70	mA mA mA	(Notes 3, 7) (Note 3) (Note 3)
I _{ID}	Supply Current in Idle Mode 80C186EC25 80C186EC20 80C186EC13		92 76 50	mA mA mA	(Notes 4, 7) (Note 4) (Note 4)
I _{PD}	Supply Current in Powerdown Mode 80C186EC25 80C186EC20 80C186EC13		100 100 100	µA µA µA	(Notes 5, 7) (Note 5) (Note 5)
C _{IN}	Input Pin Capacitance	0	15	pF	T _F = 1 MHz
C _{OUT}	Output Pin Capacitance	0	15	pF	T _F = 1 MHz (Note 6)

NOTES:

1. These pins have an internal pull-up device that is active while $\overline{\text{RESIN}}$ is low and ONCE Mode is not active. Sourcing more current than specified (on any of these pins) may invoke a factory test mode.
2. Tested by outputs being floated by invoking ONCE Mode or by asserting HOLD.
3. Measured with the device in RESET and at worst case frequency, V_{CC}, and temperature with ALL outputs loaded as specified in AC Test Conditions, and all floating outputs driven to V_{CC} or GND.
4. Measured with the device in HALT (IDLE Mode active) and at worst case frequency, V_{CC}, and temperature with ALL outputs loaded as specified in AC Test Conditions, and all floating outputs driven to V_{CC} or GND.
5. Measured with the device in HALT (Powerdown Mode active) and at worst case frequency, V_{CC}, and temperature with ALL outputs loaded as specified in AC Test Conditions, and all floating outputs driven to V_{CC} or GND.
6. Output Capacitance is the capacitive load of a floating output pin.
7. Operating conditions for 25 MHz is 0°C to +70°C, V_{CC} = 5.0 ± 10%.

DC SPECIFICATIONS (80L186EC/80L188EC)

Symbol	Parameter	Min	Max	Units	Notes
V _{CC}	Supply Voltage	2.7	5.5	V	
V _{IL}	Input Low Voltage	-0.5	0.3 V _{CC}	V	
V _{IH}	Input High Voltage	0.7 V _{CC}	V _{CC} + 0.5	V	
V _{OL}	Output Low Voltage		0.45	V	I _{OL} = 3 mA (Min)
V _{OH}	Output High Voltage	V _{CC} - 0.5		V	I _{OH} = -2 mA (Min)
V _{HYR}	Input Hysteresis on $\overline{\text{RESIN}}$	0.5		V	
I _{LI}	Input Leakage Current for Pins: AD15:0 (AD7:0, A15:8), READY, HOLD, $\overline{\text{RESIN}}$, CLKIN, TEST/BUSY, NMI, INT7:0, T0IN, T1IN, P2.7-P2.0, P3.5-P3.0, DRQ3:0, PEREQ, $\overline{\text{ERROR}}$		± 15	μA	0 ≤ V _{IN} ≤ V _{CC}
I _{LIU}	Input Leakage for Pins with Pullups Active During Reset: A19:16, $\overline{\text{LOCK}}$	-0.275	-5	mA	V _{IN} = 0.7 V _{CC} (Note 1)
I _{LO}	Output Leakage for Floated Output Pins		± 15	μA	0.45 ≤ V _{OUT} ≤ V _{CC} (Note 2)
I _{CC}	Supply Current Cold (in RESET) 80L186EC-13		36	mA	(Note 3)
I _{ID}	Supply Current in Idle Mode 80L186EC-13		24	mA	(Note 4)
I _{PD}	Supply Current in Powerdown Mode 80L186EC-13		30	μA	(Note 5)
C _{IN}	Input Pin Capacitance	0	15	pF	T _F = 1 MHz
C _{OUT}	Output Pin Capacitance	0	15	pF	T _F = 1 MHz (Note 6)

NOTES:

1. These pins have an internal pull-up device that is active while $\overline{\text{RESIN}}$ is low and ONCE Mode is not active. Sourcing more current than specified (on any of these pins) may invoke a factory test mode.
2. Tested by outputs being floated by invoking ONCE Mode or by asserting HOLD.
3. Measured with the device in RESET and at worst case frequency, V_{CC}, and temperature with **ALL** outputs loaded as specified in AC Test Conditions, and all floating outputs driven to V_{CC} or GND.
4. Measured with the device in HALT (IDLE Mode active) and at worst case frequency, V_{CC}, and temperature with **ALL** outputs loaded as specified in AC Test Conditions, and all floating outputs driven to V_{CC} or GND.
5. Measured with the device in HALT (Powerdown Mode active) and at worst case frequency, V_{CC}, and temperature with **ALL** outputs loaded as specified in AC Test Conditions, and all floating outputs driven to V_{CC} or GND.
6. Output Capacitance is the capacitive load of a floating output pin.

1



I_{CC} versus Frequency and Voltage

The I_{CC} consumed by the processor is composed of two components:

1. I_{PD}—The quiescent current that represents internal device leakage. Measured with all inputs at either V_{CC} or ground and no clock applied.
2. I_{CCS}—The switching current used to charge and discharge internal parasitic capacitance when changing logic levels. I_{CCS} is related to both the frequency of operation and the device supply voltage (V_{CC}). I_{CCS} is given by the formula:

$$\text{Power} = V * I = V^2 * C_{DEV} * f$$

$$\therefore I_{CCS} = V * C_{DEV} * f$$

Where:

- V = Supply Voltage (V_{CC})
- C_{DEV} = Device Capacitance
- f = Operating Frequency

Measuring C_{PD} on a device like the 80C186EC would be difficult. Instead, C_{PD} is calculated using the above formula with I_{CC} values measured at known V_{CC} and frequency. Using the C_{PD} value, the user can calculate I_{CC} at any voltage and frequency within the specified operating range.

Example. Calculate typical I_{CC} at 14 MHz, 5.2V V_{CC}.

$$I_{CC} = I_{PD} + I_{CCS}$$

$$= 0.1 \text{ mA} + 5.2V * 0.77 * 14 \text{ MHz}$$

$$= 56.2 \text{ mA}$$

PDTMR Pin Delay Calculation

The PDTMR pin provides a delay between the assertion of NMI and the enabling of the internal clocks when exiting Powerdown Mode. A delay is required only when using the on chip oscillator to allow the crystal or resonator circuit to stabilize.

NOTE:

The PDTMR pin function does not apply when RESIN is asserted (i.e. a device reset while in Powerdown is similar to a cold reset and RESIN must remain active until after the oscillator has stabilized.

To calculate the value of capacitor to use to provide a desired delay, use the equation:

$$440 * t = C_{PD} (5V, 25^{\circ}C)$$

Where:

- t = desired delay in **seconds**
- C_{PD} = capacitive load on PDTMR in **microfarads**

Example. For a delay of 300 μs, a capacitor value of C_{PD} = 440 × (300 × 10⁻⁶) = 0.132 μF is required. Round up to a standard (available) capacitor value.

NOTE:

The above equation applies to delay time longer than 10 μs and will compute the **TYPICAL** capacitance needed to achieve the desired delay. A delay variance of +50% to -25% can occur due to temperature, voltage, and device process extremes. In general, higher V_{CC} and/or lower temperatures will decrease delay time, while lower V_{CC} and/or higher temperature will increase delay time.

Parameter	Typical	Max	Units	Notes
CPD	0.77	1.37	mA/V*MHz	1, 2
CPD (Idle Mode)	0.55	0.96	mA/V*MHz	1, 2

NOTES:

1. Maximum C_{PD} is measured at -40°C with all outputs loaded as specified in the AC test conditions and the device in reset (or Idle Mode). Due to tester limitations, CLKOUT and OSCOUT also have 50 pF loads that increase I_{CC} by V°C°F.
2. Typical C_{PD} is calculated at 25°C assuming no loads on CLKOUT or OSCOUT and the device in reset (or Idle Mode).



AC SPECIFICATIONS

AC Characteristics—80C186EC25

Symbol	Parameter	25 MHz		Units	Notes
		Min	Max		
INPUT CLOCK					
T _F	CLKIN Frequency	0	50	MHz	1
T _C	CLKIN Period	20	∞	ns	1
T _{CH}	CLKIN High Time	8	∞	ns	1, 2
T _{CL}	CLKIN Low Time	8	∞	ns	1, 2
T _{CR}	CLKIN Rise Time	1	10	ns	1, 3
T _{CF}	CLKIN Fall Time	1	10	ns	1, 3
OUTPUT CLOCK					
T _{CD}	CLKIN to CLKOUT Delay	0	17	ns	1, 4
T	CLKOUT Period		2*T _C	ns	1
T _{PH}	CLKOUT High Time	(T/2) - 5	(T/2) + 5	ns	1
T _{PL}	CLKOUT Low Time	(T/2) - 5	(T/2) + 5	ns	1
T _{PR}	CLKOUT Rise Time	1	6	ns	1, 5
T _{PF}	CLKOUT Fall Time	1	6	ns	1, 5
OUTPUT DELAYS					
T _{CHOV1}	ALE, S2:0, DEN, DT/R, BHE (RFSH), LOCK, A19:16	3	17	ns	1, 4, 6, 7
T _{CHOV2}	GCS0:7, LCS, UCS, NCS, RD, WR	3	20	ns	1, 4, 6, 8
T _{CLOV1}	BHE (RFSH), DEN, LOCK, RESOUT, HLDA, T0OUT, T1OUT, A19:16	3	17	ns	1, 4, 6
T _{CLOV2}	RD, WR, GCS7:0, LCS, UCS, AD15:0 (AD7:0, A15:8), NCS, INTA1:0, S2:0	3	20	ns	1, 4, 6
T _{CHOF}	RD, WR, BHE (RFSH), DT/R, LOCK, S2:0, A19:16	0	20	ns	1
T _{CLOF}	DEN, AD15:0 (AD7:0, A15:8)	0	20	ns	1

1

AC SPECIFICATIONS

AC Characteristics—80C186EC25 (Continued)

Symbol	Parameter	25 MHz		Units	Notes
		Min	Max		
SYNCHRONOUS INPUTS					
T _{CHIS}	TEST, NMI, INT4:0, BCLK1:0, T1:0IN, READY, $\overline{\text{CTS1:0}}$, P2.6, P2.7	10		ns	1, 9
T _{CHIH}	TEST, NMI, INT4:0, BCLK1:0, T1:0IN, READY, $\overline{\text{CTS1:0}}$	3		ns	1, 9
T _{CLIS}	AD15:0 (AD7:0), READY	10		ns	1, 10
T _{CLIH}	READY, AD15:0 (AD7:0)	3		ns	1, 10
T _{CLIS}	HOLD, PEREQ, ERROR	10		ns	1, 9
T _{CLIH}	HOLD, PEREQ, ERROR	3		ns	1, 9

NOTES:

1. See **AC Timing Waveforms**, for waveforms and definition.
2. Measure at V_{IH} for high time, V_{IL} for low time.
3. Only required to guarantee I_{CC}. Maximum limits are bounded by T_C, T_{CH} and T_{CL}.
4. Specified for a 50 pF load, see Figure 13 for capacitive derating information.
5. Specified for a 50 pF load, see Figure 14 for rise and fall times outside 50 pF.
6. See Figure 14 for rise and fall times.
7. T_{CHOV1} applies to $\overline{\text{BHE}}$ (RFSH), $\overline{\text{LOCK}}$ and A19:16 only after a HOLD release.
8. T_{CHOV2} applies to RD and WR only after a HOLD release.
9. Setup and Hold are required to guarantee recognition.
10. Setup and Hold are required for proper operation.

AC SPECIFICATIONS
AC Characteristics—80C186EC-20/80C186EC-13

Symbol	Parameter	Min	Max	Min	Max	Unit	Notes
INPUT CLOCK		20 MHz		13 MHz			
TF	CLKIN Frequency	0	40	0	26	MHz	1
TC	CLKIN Period	25	∞	38.5	∞	ns	1
TCH	CLKIN High Time	10	∞	12	∞	ns	1, 2
TCL	CLKIN Low Time	10	∞	12	∞	ns	1, 2
TCR	CLKIN Rise Time	1	10	1	10	ns	1, 3
TCF	CLKIN Fall Time	1	10	1	10	ns	1, 3
OUTPUT CLOCK							
T _{CD}	CLKIN to CLKOUT Delay	0	17	0	23	ns	1, 4
T	CLKOUT Period		2 * TC		2 * TC	ns	1
T _{PH}	CLKOUT High Time	(T/2) - 5	(T/2) + 5	(T/2) - 5	(T/2) + 5	ns	1
T _{PL}	CLKOUT Low Time	(T/2) - 5	(T/2) + 5	(T/2) - 5	(T/2) + 5	ns	1
T _{PR}	CLKOUT Rise Time	1	6	1	6	ns	1, 5
T _{PF}	CLKOUT Fall Time	1	6	1	6	ns	1, 5
OUTPUT DELAYS							
T _{CHOV1}	ALE, S2:0, DEN, DT/R, BHE (RFSH), LOCK, A19:16	3	20	3	25	ns	1, 4, 6, 7
T _{CHOV2}	GCS7:0, LCS, UCS, RD, WR, NCS, WDOUT	3	23	3	30	ns	1, 4, 6, 8
T _{CLOV1}	BHE (RFSH), DEN, LOCK, RESOUT, HLDA, T0OUT, T1OUT	3	20	3	25	ns	1, 4, 6
T _{CLOV2}	RD, WR, GSC7:0, LCS, UCS, AD15:0 (AD7:0, A15:8), NCS, INTA, S2:0, A19:16	3	23	3	30	ns	1, 4, 6
T _{CHOF}	RD, WR, BHE (RFSH), DT/R, LOCK, S2:0, A19:16	0	25	0	30	ns	1
T _{CLOF}	DEN, AD15:0 (AD7:0, A15:8)	0	25	0	30	ns	1
INPUT REQUIREMENTS							
T _{CHIS}	TEST, NMI, T1IN, T0IN, READY, CTS1:0, BCLK1:0, P3.4, P3.5	10		10		ns	1, 9
T _{CHIH}	TEST, NMI, T1IN, T0IN, READY, CTS1:0, BCLK1:0, P3.4, P3.5	3		3		ns	1, 9
T _{CLIS}	AD15:0 (AD7:0), READY	10		10		ns	1, 10
T _{CLIH}	AD15:0 (AD7:0), READY	3		3		ns	1, 10
T _{CLIS}	HOLD, RESIN, PEREQ, ERROR, DRQ3:0	10		10		ns	1, 9
T _{CLIH}	HOLD, RESIN, REREQ, ERROR, DRQ3:0	3		3		ns	1, 9

NOTES:

- See **AC Timing Waveforms**, for waveforms and definition.
- Measure at V_{IH} for high time, V_{IL} for low time.
- Only required to guarantee I_{CC}. Maximum limits are bounded by T_C, T_{CH} and T_{CL}.
- Specified for a 50 pF load, see Figure 14 for capacitive derating information.
- Specified for a 50 pF load, see Figure 15 for rise and fall times outside 50 pF.
- See Figure 15 for rise and fall times.
- T_{CHOV1} applies to BHE (RFSH), LOCK and A19:16 only after a HOLD release.
- T_{CHOV2} applies to RD and WR only after a HOLD release.
- Setup and Hold are required to guarantee recognition.
- Setup and Hold are required for proper operation.

1

AC Characteristics—80L186EC13

Symbol	Parameter	Min	Max	Unit	Notes
INPUT CLOCK		13 MHz			
TF	CLKIN Frequency	0	26	MHz	1
TC	CLKIN Period	38.5	∞	ns	1
TCH	CLKIN High Time	15	∞	ns	1, 2
TCL	CLKIN Low Time	15	∞	ns	1, 2
TCR	CLKIN Rise Time	1	10	ns	1, 3
TCF	CLKIN Fall Time	1	10	ns	1, 3
OUTPUT CLOCK					
T _{CD}	CLKIN to CLKOUT Delay	0	20	ns	1, 4
T	CLKOUT Period		2 * TC	ns	1
T _{PH}	CLKOUT High Time	(T/2) - 5	(T/2) + 5	ns	1
T _{PL}	CLKOUT Low Time	(T/2) - 5	(T/2) + 5	ns	1
T _{PR}	CLKOUT Rise Time	1	10	ns	1, 5
T _{PF}	CLKOUT Fall Time	1	10	ns	1, 5
OUTPUT DELAYS					
T _{CHOV1}	$\overline{S2:0}$, DT/R, \overline{BHE} , \overline{LOCK}	3	28	ns	1, 4, 6, 7
T _{CHOV2}	\overline{LCS} , \overline{UCS} , DEN, A19:16, RD, WR, NCS, WDTOUT, ALE	3	32	ns	1, 4, 6, 8
T _{CHOV3}	$\overline{GCS7:0}$	3	34	ns	1, 4, 6
T _{CLOV1}	\overline{LOCK} , RESOUT, HLDA, T0OUT, T1OUT	3	28	ns	1, 4, 6
T _{CLOV2}	RD, WR, AD15:0 (AD7:0, A15:8), \overline{BHE} (RFSH), NCS, INTA, DEN	3	32	ns	1, 4, 6
T _{CLOV3}	$\overline{GSC7:0}$, \overline{LCS} , \overline{UCS}	3	34	ns	1, 4, 6
T _{CLOV4}	$\overline{S2:0}$, A19:16	3	37	ns	1, 4, 6
T _{CHOF}	RD, WR, \overline{BHE} (RFSH), DT/R, \overline{LOCK} , $\overline{S2:0}$, A19:16	0	30	ns	1
T _{CLOF}	DEN, AD15:0 (AD7:0, A15:8)	0	35	ns	1
INPUT REQUIREMENTS					
T _{CHIS}	\overline{TEST} , NMI, T1IN, T0IN, READY, CTST1:0, BCLK1:0, P3.4, P3.5	20		ns	1, 9
T _{CHIH}	\overline{TEST} , NMI, T1IN, T0IN, READY, CTST1:0, BCLK1:0, P3.4, P3.5	3		ns	1, 9
T _{CLIS}	AD15:0 (AD7:0), READY	20		ns	1, 10
T _{CLIH}	AD15:0 (AD7:0), READY	3		ns	1, 10
T _{CLIS}	HOLD, \overline{RESIN} , PEREQ, \overline{ERROR} , DRQ3:0	20		ns	1, 9
T _{CLIH}	HOLD, \overline{RESIN} , REREQ, \overline{ERROR} , DRQ3:0	3		ns	1, 9

NOTES:

- See **AC Timing Waveforms**, for waveforms and definition.
- Measure at V_{IH} for high time, V_{IL} for low time.
- Only required to guarantee I_{CC}. Maximum limits are bounded by T_C, T_{CH} and T_{CL}.
- Specified for a 50 pF load, see Figure 14 for capacitive derating information.
- Specified for a 50 pF load, see Figure 15 for rise and fall times outside 50 pF.

AC Characteristics—80L186EC (Continued)
NOTES:

6. See Figure 15 for rise and fall times.
7. T_{CHOV1} applies to $\overline{\text{BHE}}$ (RFSH), $\overline{\text{LOCK}}$ and A19:16 only after a HOLD release.
8. T_{CHOV2} applies to $\overline{\text{RD}}$ and $\overline{\text{WR}}$ only after a HOLD release.
9. Setup and Hold are required to guarantee recognition.
10. Setup and Hold are required for proper operation.

Relative Timings (80C186EC-25/20/13, 80L186EC13)

Symbol	Parameter	Min	Max	Unit	Notes
RELATIVE TIMINGS					
T _{LHLL}	ALE Active Pulse Width	T - 15		ns	
T _{AVLL}	AD Valid Setup before ALE Falls	$\frac{1}{2}T - 10$		ns	
T _{PLLL}	Chip Select Valid before ALE Falls	$\frac{1}{2}T - 10$		ns	1
T _{LLAX}	AD Hold after ALE Falls	$\frac{1}{2}T - 10$		ns	
T _{LLWL}	ALE Falling to $\overline{\text{WR}}$ Falling	$\frac{1}{2}T - 15$		ns	1
T _{LLRL}	ALE Falling to $\overline{\text{RD}}$ Falling	$\frac{1}{2}T - 15$		ns	1
T _{WHLH}	$\overline{\text{WR}}$ Rising to Next ALE Rising	$\frac{1}{2}T - 10$		ns	1
T _{AFRL}	AD Float to $\overline{\text{RD}}$ Falling	0		ns	
T _{RLRH}	$\overline{\text{RD}}$ Active Pulse Width	2T - 5		ns	2
T _{WLWH}	$\overline{\text{WR}}$ Active Pulse Width	2T - 5		ns	2
T _{RHAX}	$\overline{\text{RD}}$ Rising to Next Address Active	T - 15		ns	
T _{WHDX}	Output Data Hold after $\overline{\text{WR}}$ Rising	T - 15		ns	
T _{WHPH}	$\overline{\text{WR}}$ Rise to Chip Select Rise	$\frac{1}{2}T - 10$		ns	1
T _{RHPH}	$\overline{\text{RD}}$ Rise to Chip Select Rise	$\frac{1}{2}T - 10$		ns	1
T _{PHPL}	Chip Select Inactive to Next Chip Select Active	$\frac{1}{2}T - 10$		ns	1
T _{OVRH}	$\overline{\text{ONCE}}$ Active Setup to RESIN Rising	T		ns	
T _{RHOX}	$\overline{\text{ONCE}}$ Hold after RESIN Rise	T		ns	
T _{IHIL}	$\overline{\text{INTA}}$ High to Next $\overline{\text{INTA}}$ Low during INTA Cycle	4T - 5		ns	4
T _{IЛИH}	$\overline{\text{INTA}}$ Active Pulse Width	2T - 5		ns	2, 4
T _{CVIL}	CAS2:0 Setup before 2nd $\overline{\text{INTA}}$ Pulse Low	8T		ns	2, 4

1

Relative Timings (80C186EC-25/20/13, 80L186EC13) (Continued)

Symbol	Parameter	Min	Max	Unit	Notes
RELATIVE TIMINGS					
T_{ILCX}	CAS2:0 Hold after 2nd \overline{INTA} Pulse Low	4T		ns	2, 4
T_{IRES}	Interrupt Resolution Time		150	ns	3
T_{IRLH}	IR Low Time to Reset Edge Detector	50		ns	
T_{IRHIF}	IR Hold Time after 1st \overline{INTA} Falling	25		ns	4, 5

NOTES:

1. Assumes equal loading on both pins.
2. Can be extended using wait states.
3. Interrupt resolution time is the delay between an unmasked interrupt request going active and the interrupt output of the 8259A module going active. This is not directly measurable by the user. For interrupt pin INT7 the delay from an active signal to an active input to the CPU would actually be twice the T_{IRES} value since the signal must pass through two 8259A modules.
4. See INTA Cycle Waveforms for definition.
5. To guarantee interrupt is not spurious.

Serial Port Mode 0 Timings (80C186EC-25/20/13, 80L186EC13)

Symbol	Parameter	Min	Max	Unit	Notes
RELATIVE TIMINGS					
T_{XLXL}	TXD Clock Period	$T(n + 1)$		ns	1, 2
T_{XLXH}	TXD Clock Low to Clock High ($N > 1$)	$2T - 35$	$2T + 35$	ns	1
T_{XLXH}	TXD Clock Low to Clock High ($N = 1$)	$T - 35$	$T + 35$	ns	1
T_{XHXL}	TXD Clock High to Clock Low ($N > 1$)	$(n - 1)T - 35$	$(n - 1)T + 35$	ns	1, 2
T_{XHXL}	TXD Clock High to Clock Low ($N = 1$)	$T - 35$	$T + 35$	ns	1
T_{QVXH}	RXD Output Data Setup to TXD Clock High ($N > 1$)	$(n - 1)T - 35$		ns	1, 2
T_{QVXH}	RXD Output Data Setup to TXD Clock High ($N = 1$)	$T - 35$		ns	1
T_{XHQX}	RXD Output Data Hold after TXD Clock High ($N > 1$)	$2T - 35$		ns	1
T_{XHQX}	RXD Output Data Hold after TXD Clock High ($N = 1$)	$T - 35$		ns	1
T_{XHQZ}	RXD Output Data Float after Last TXD Clock High		$T + 20$	ns	1
T_{DVXH}	RXD Input Data Setup to TXD Clock High	$T + 20$		ns	1
T_{XHDX}	RXD Input Data Setup after TXD Clock High	0		ns	1

NOTES:

1. See Figure 13 for Waveforms.
2. n is the value in the BxCMP register ignoring the ICLK bit.

AC TEST CONDITIONS

The AC specifications are tested with the 50 pF load shown in Figure 7. See the Derating Curves section to see how timings vary with load capacitance.

Specifications are measured at the $V_{CC}/2$ crossing point, unless otherwise specified. See AC Timing Waveforms for AC specification definitions, test pins and illustrations.

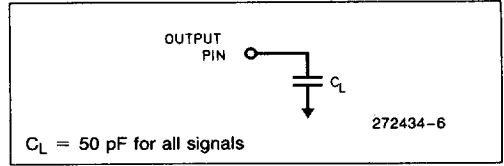

Figure 7. AC Test Load

AC TIMING WAVEFORMS

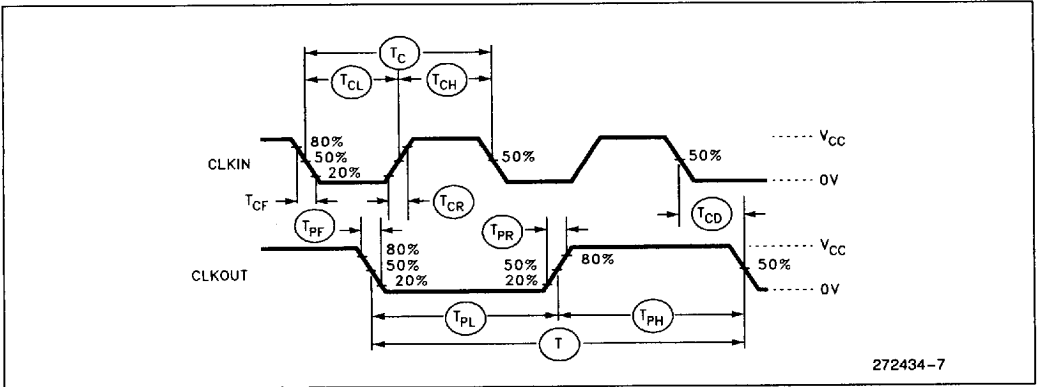

Figure 8. Input and Output Clock Waveforms

1

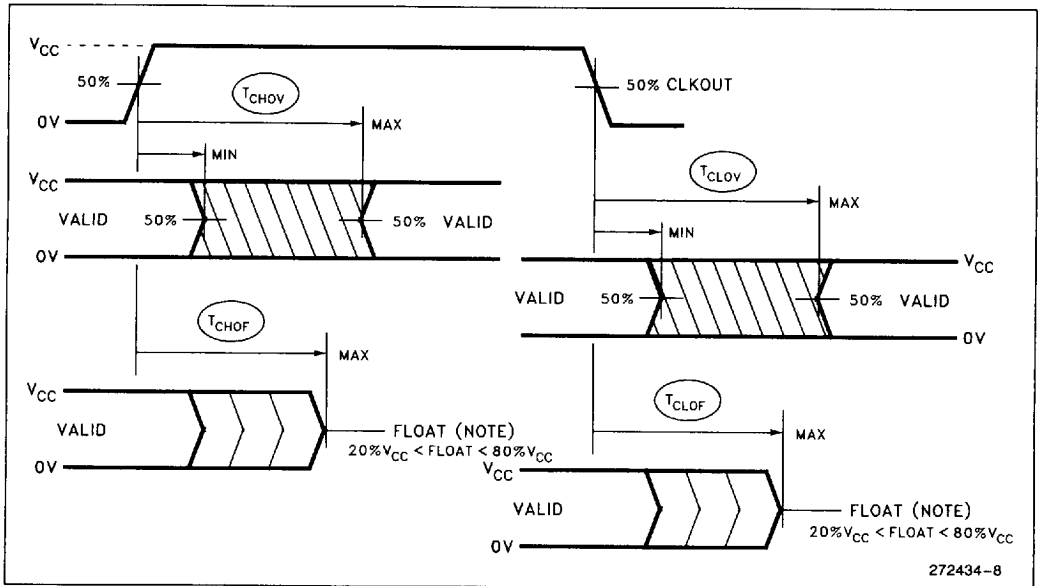

Figure 9. Output Delay and Float Waveforms

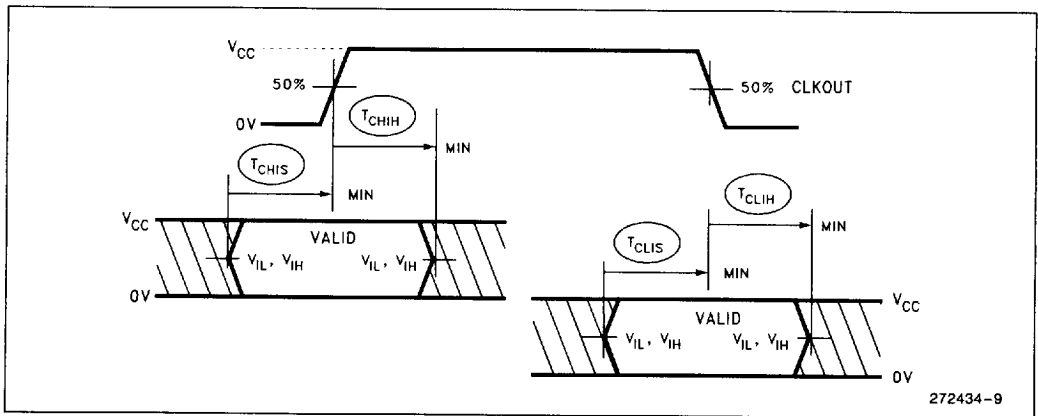

Figure 10. Input Setup and Hold

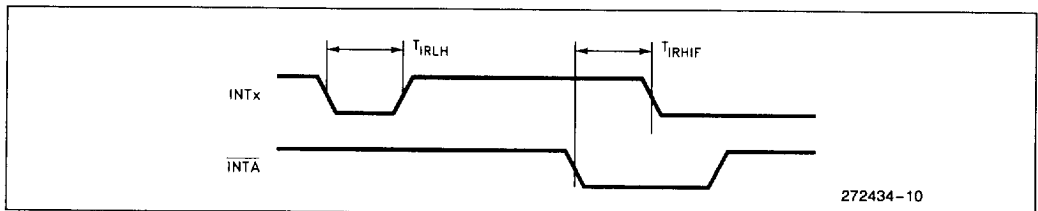

Figure 11. Relative Interrupt Signal Timings

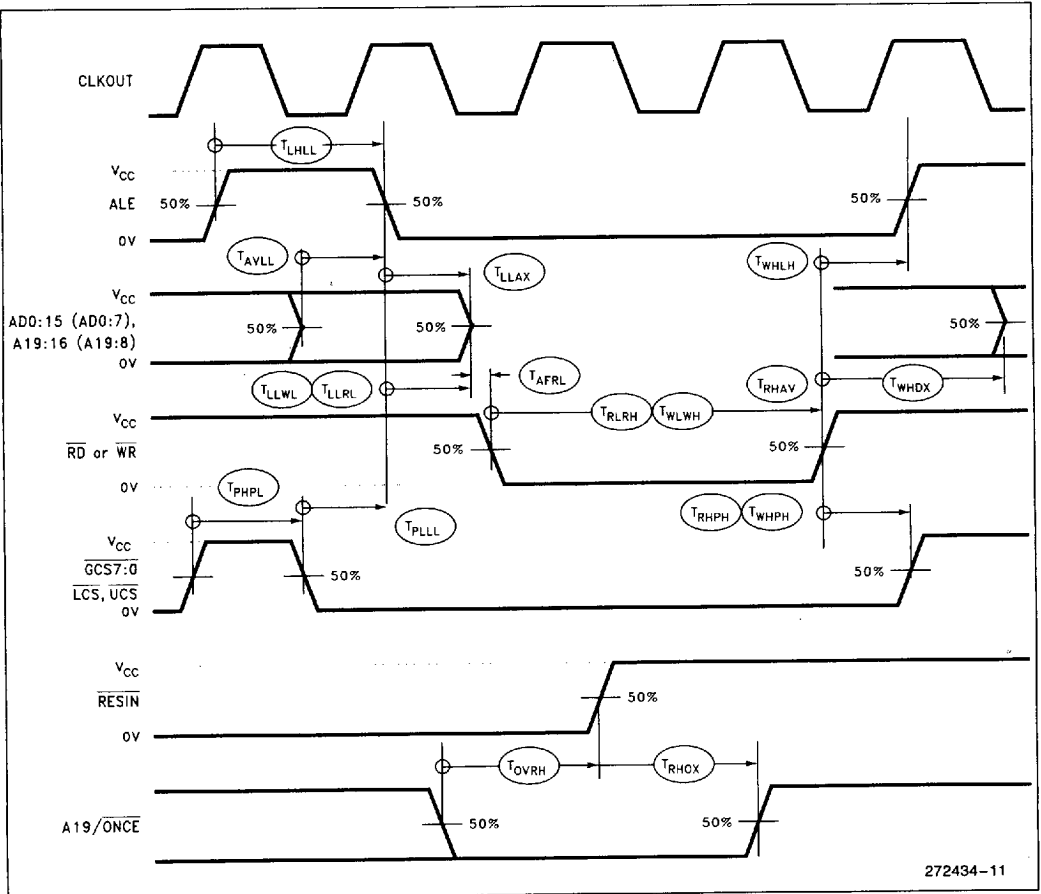

Figure 12. Relative Signal Waveform

272434-11

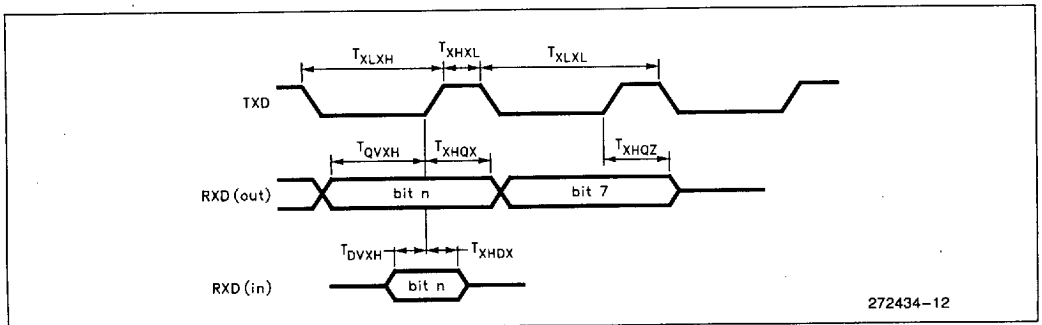

Figure 13. Serial Port Mode 0 Waveform

272434-12

1

DERATING CURVES

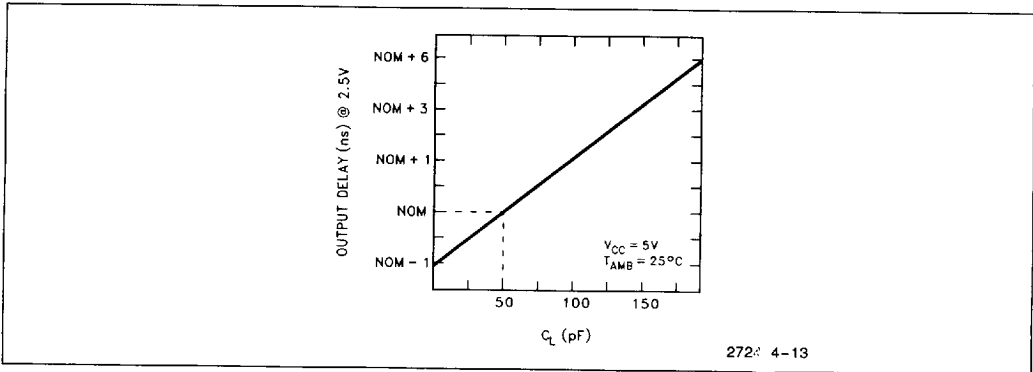

Figure 14. Typical Output Delay Variations versus Load Capacitance

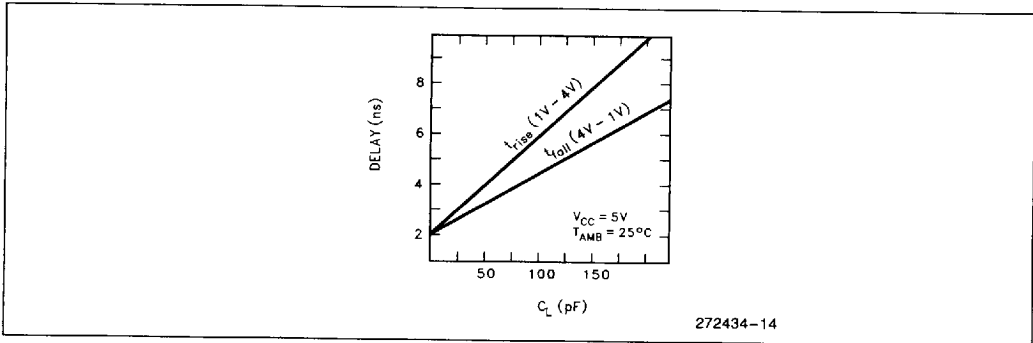

Figure 15. Typical Rise and Fall Variations versus Load Capacitance

RESET

The processor will perform a reset operation any time the $\overline{\text{RESIN}}$ pin is active. The $\overline{\text{RESIN}}$ pin is synchronized before it is presented internally, which means that the clock must be operating before a reset can take effect. From a power-on state, $\overline{\text{RESIN}}$ must be held active (low) in order to guarantee correct initialization of the processor. **Failure to provide $\overline{\text{RESIN}}$ while the device is powering up will result in unspecified operation of the device.**

Figure 16 shows the correct reset sequence when first applying power to the processor. An external clock connected to CLKIN must not exceed the V_{CC} threshold being applied to the processor. This is normally not a problem if the clock driver is supplied with the same V_{CC} that supplies the processor. When attaching a crystal to the device, $\overline{\text{RESIN}}$ must remain active until both V_{CC} and CLKOUT are stable (the length of time is application specific and depends on the startup characteristics of the crystal circuit). The $\overline{\text{RESIN}}$ pin is designed to operate cor-

rectly using a RC reset circuit, but the designer must ensure that the ramp time for V_{CC} is not so long that $\overline{\text{RESIN}}$ is never sampled at a logic low level when V_{CC} reaches minimum operating conditions.

Figure 17 shows the timing sequence when $\overline{\text{RESIN}}$ is applied after V_{CC} is stable and the device has been operating. Note that a reset will terminate all activity and return the processor to a known operating state. Any bus operation that is in progress at the time $\overline{\text{RESIN}}$ is asserted will terminate immediately (note that most control signals will be driven to their inactive state first before floating).

While $\overline{\text{RESIN}}$ is active, bus signals $\overline{\text{LOCK}}$, A19/S16/ $\overline{\text{ONCE}}$ and A18:16 are configured as inputs and weakly held high by internal pullup transistors. Only A19/ $\overline{\text{ONCE}}$ can be overdriven to a low and is used to enable the ONCE Mode. Forcing $\overline{\text{LOCK}}$ or A18:16 low at any time while $\overline{\text{RESIN}}$ is low is prohibited and will cause unspecified device operation.

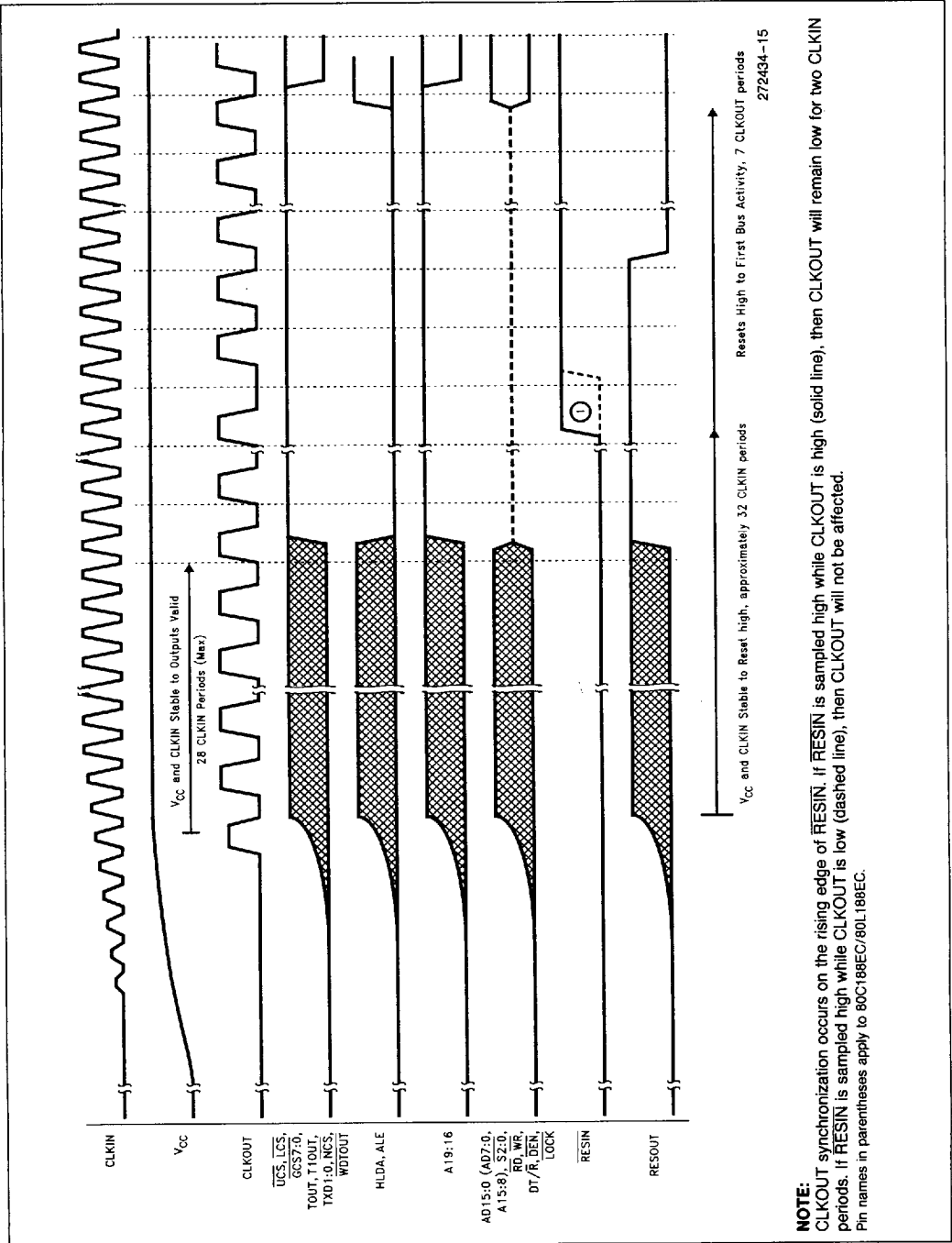
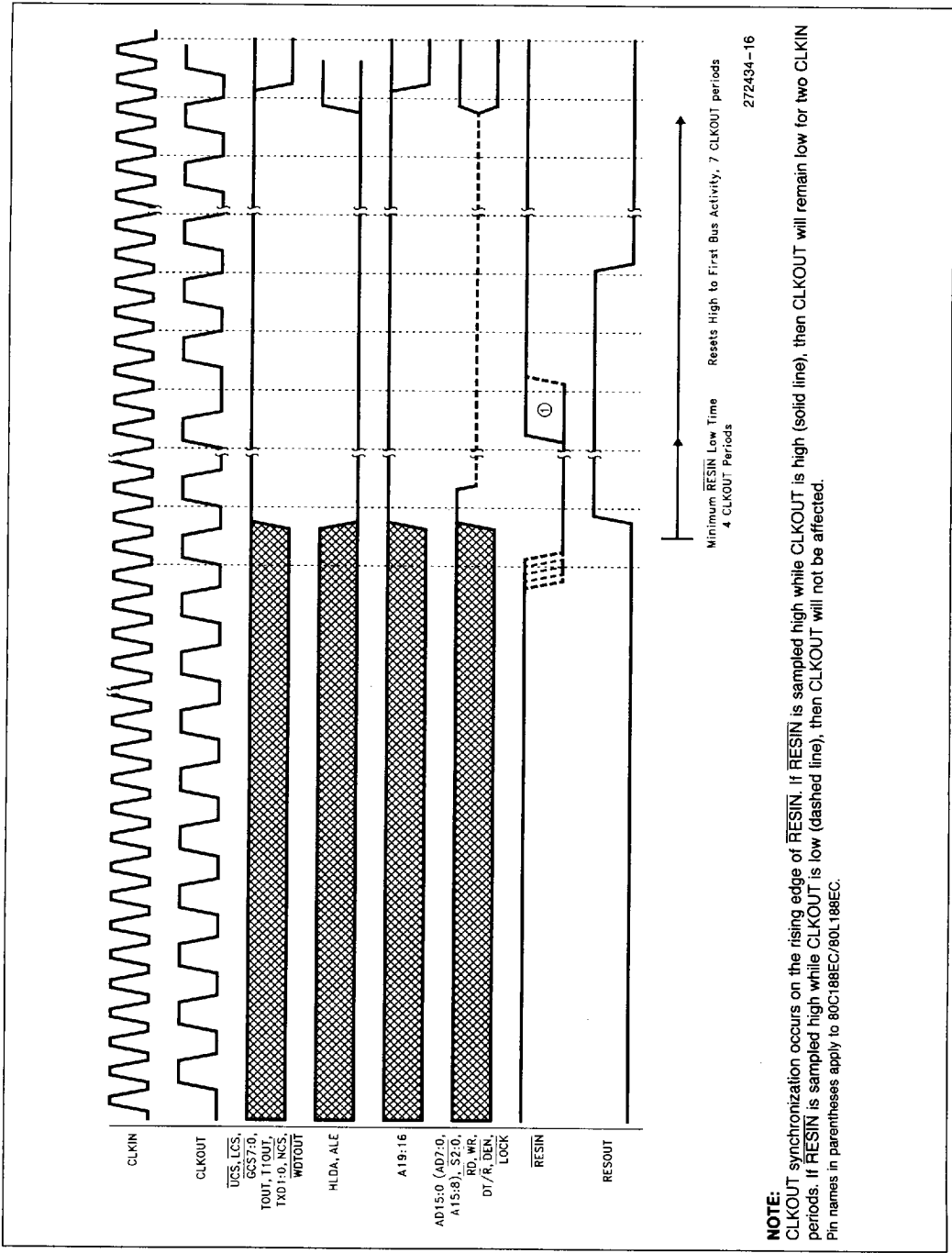

Figure 16. Cold RESET Waveforms

NOTE: CLKOUT synchronization occurs on the rising edge of RESIN. If RESIN is sampled high while CLKOUT is high (solid line), then CLKOUT will remain low for two CLKIN periods. If RESIN is sampled high while CLKOUT is low (dashed line), then CLKOUT will not be affected. Pin names in parentheses apply to 80C188EC/80L188EC.



NOTE:
 CLKOUT synchronization occurs on the rising edge of RESIN. If RESIN is sampled high while CLKOUT is high (solid line), then CLKOUT will remain low for two CLKIN periods. If RESIN is sampled high while CLKOUT is low (dashed line), then CLKOUT will not be affected.
 Pin names in parentheses apply to 80C186EC/80L188EC.

Figure 17. Warm RESET Waveforms

BUS CYCLE WAVEFORMS

Figures 18 through 24 present the various bus cycles that are generated by the processor. What is shown in the figure is the relationship of the various

bus signals to CLKOUT. These figures along with the information present in AC Specifications allow the user to determine all the critical timing analysis needed for a given application.

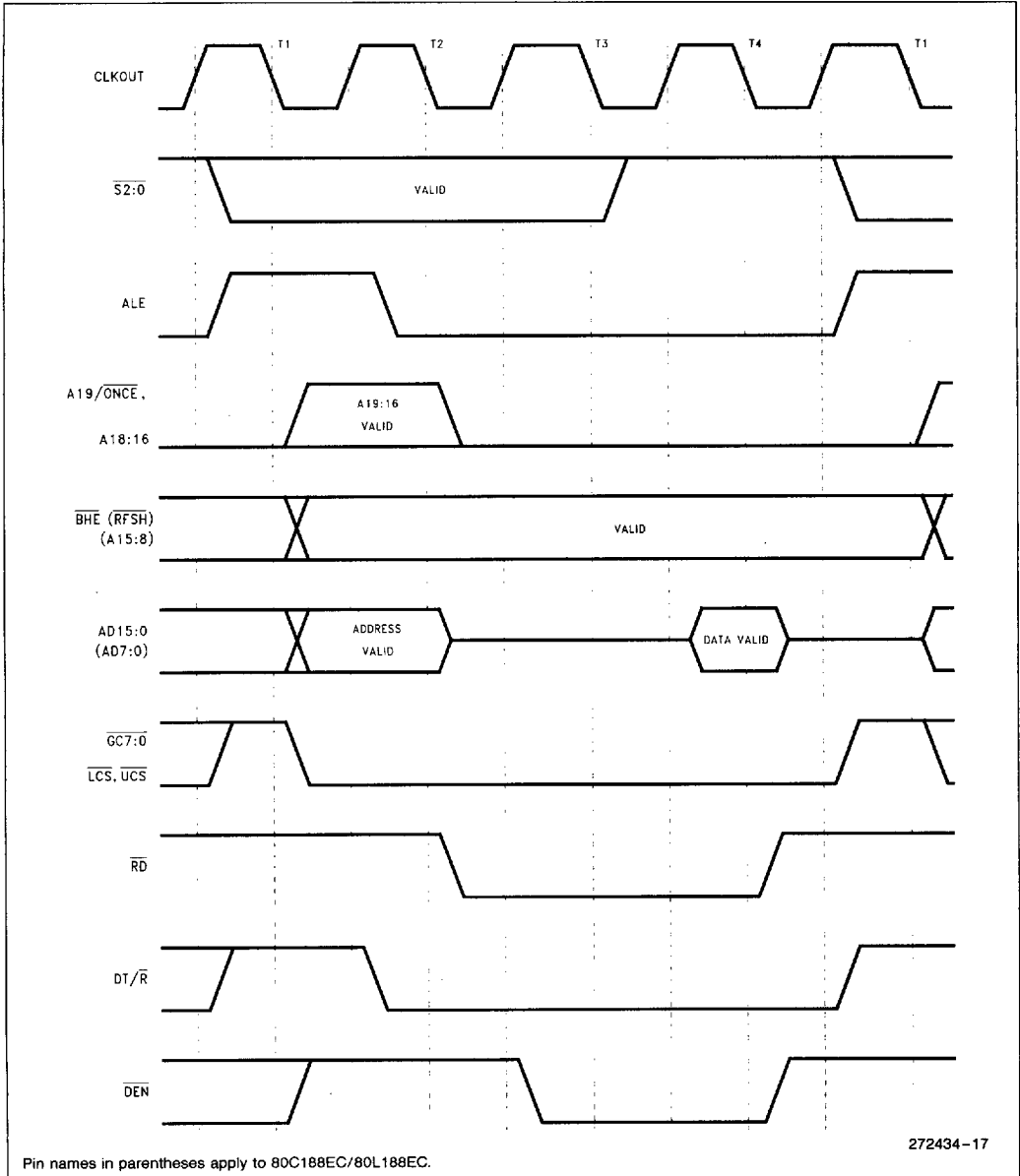

Figure 18. Memory Read, I/O Read, Instruction Fetch and Refresh Waveforms

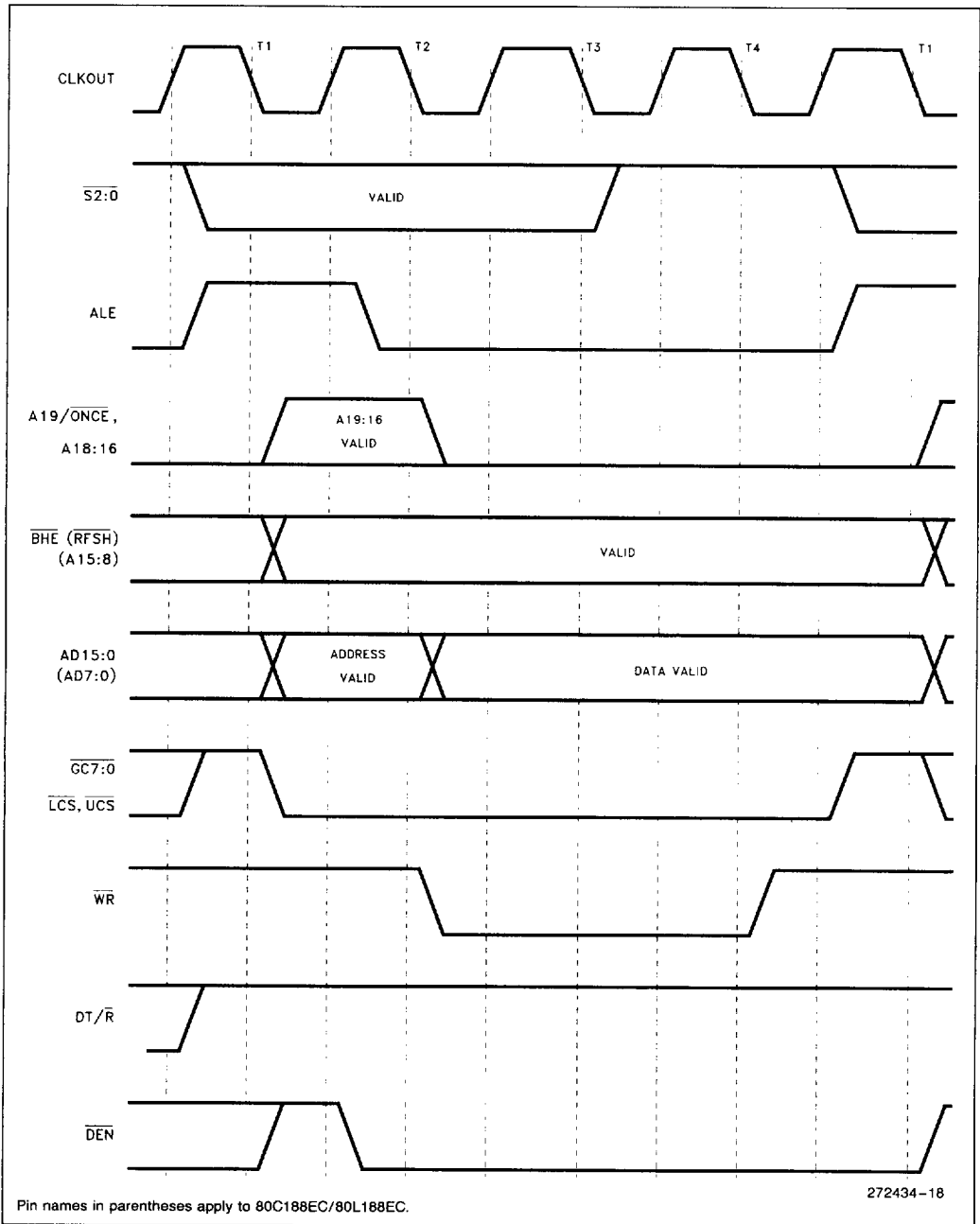

Figure 19. Memory Write and I/O Write Cycle Waveforms

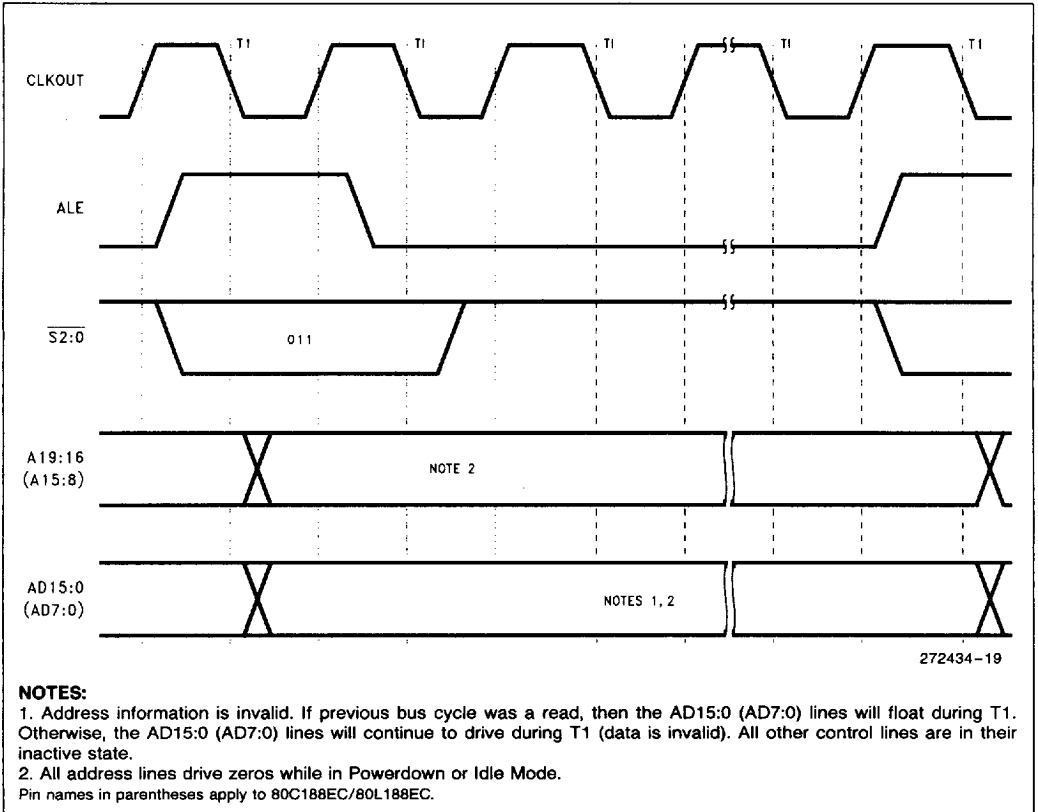

Figure 20. Halt Cycle Waveforms

1

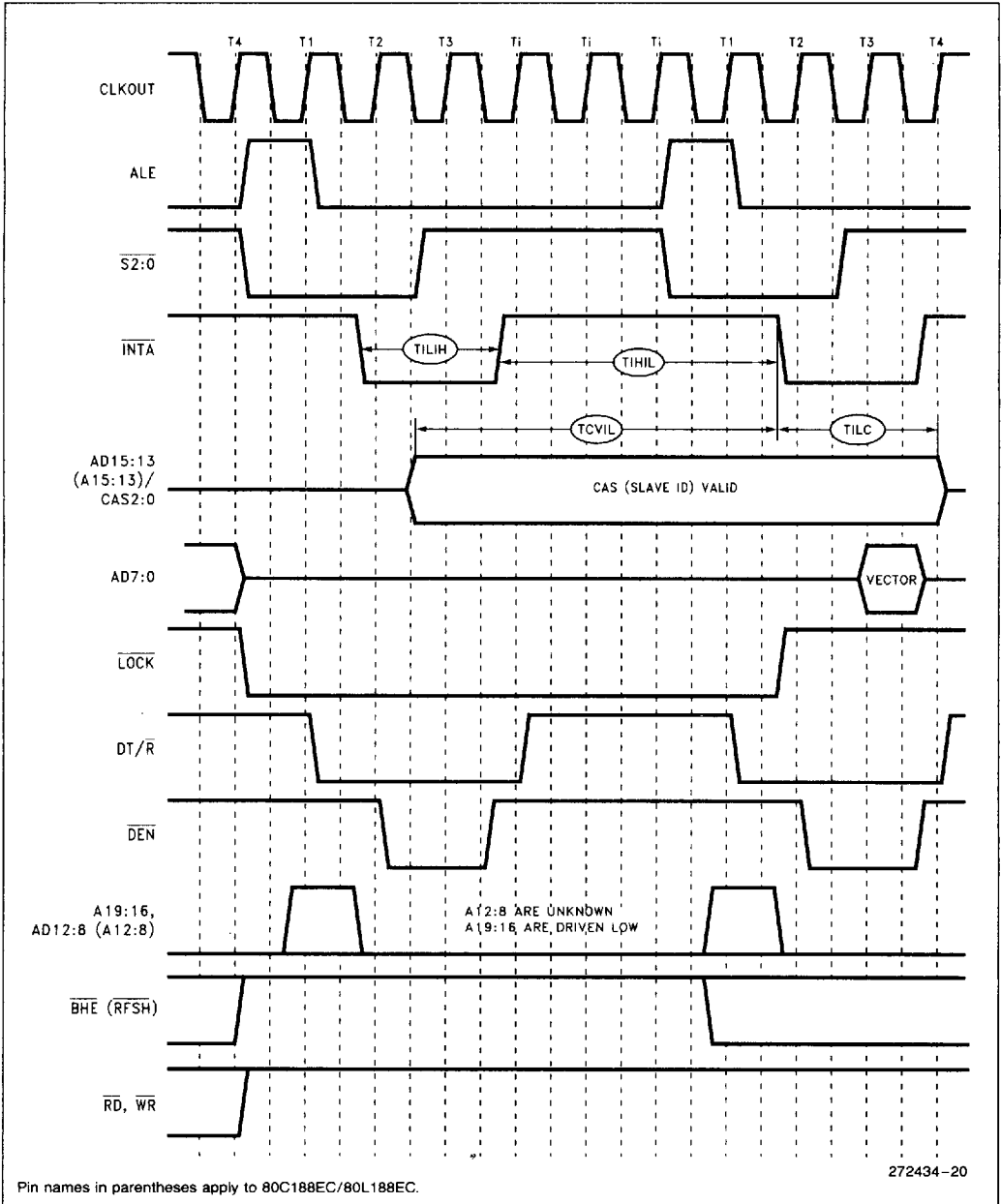
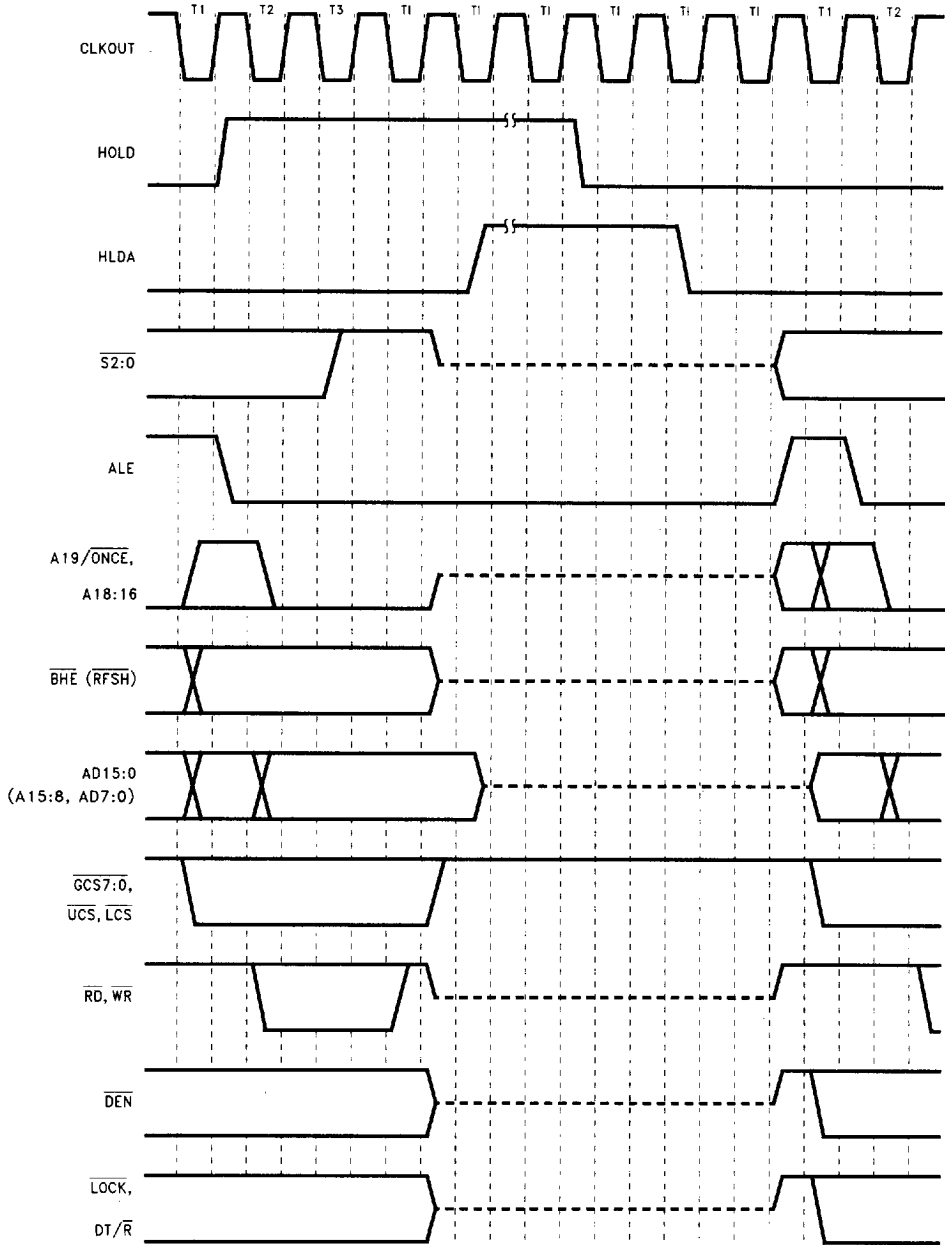

Figure 21. Interrupt Acknowledge Cycle Waveforms



Pin names in parentheses apply to 80C188EC/80L188EC.

272434-21

Figure 22. HOLD/HLDA Cycle Waveforms

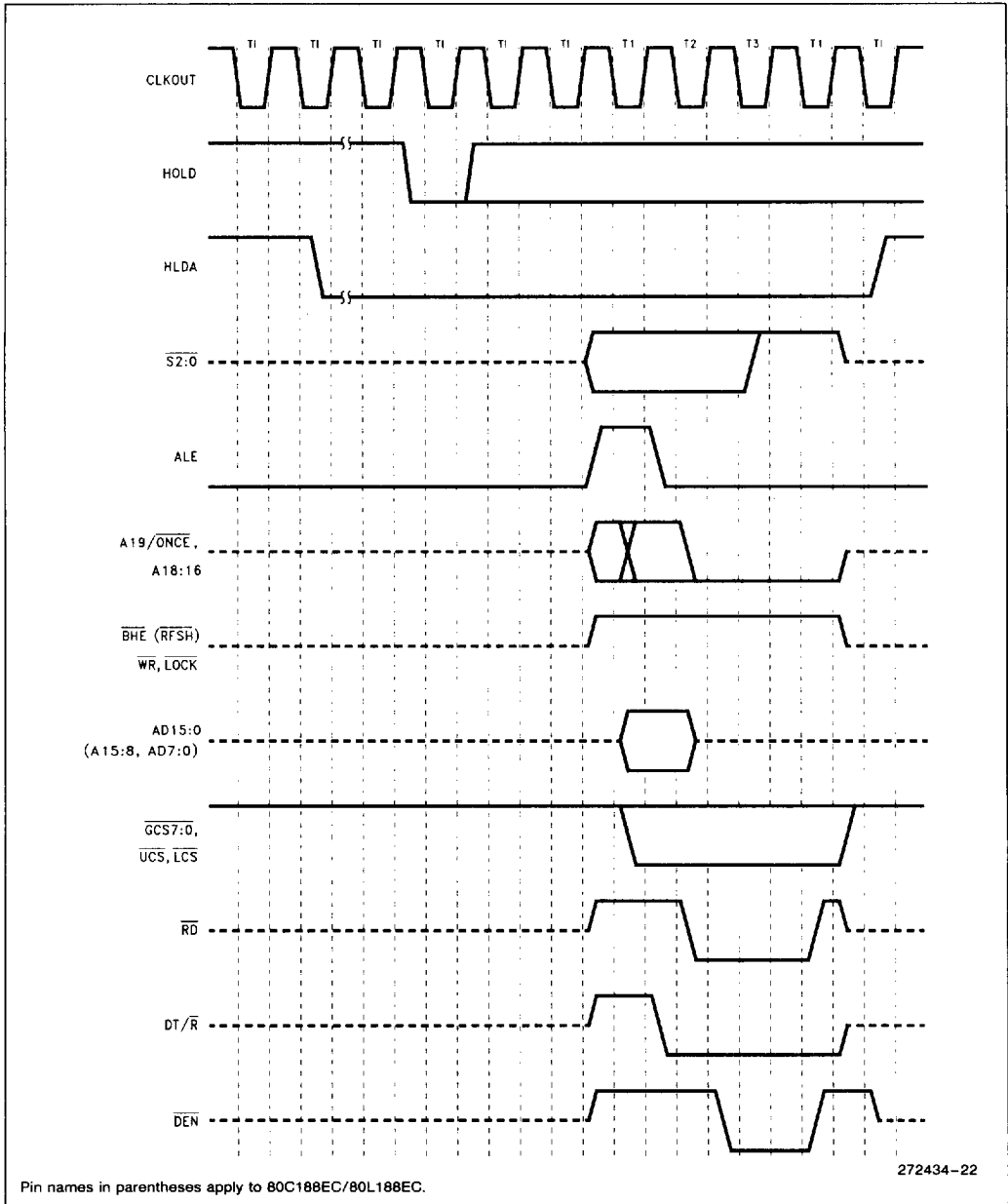
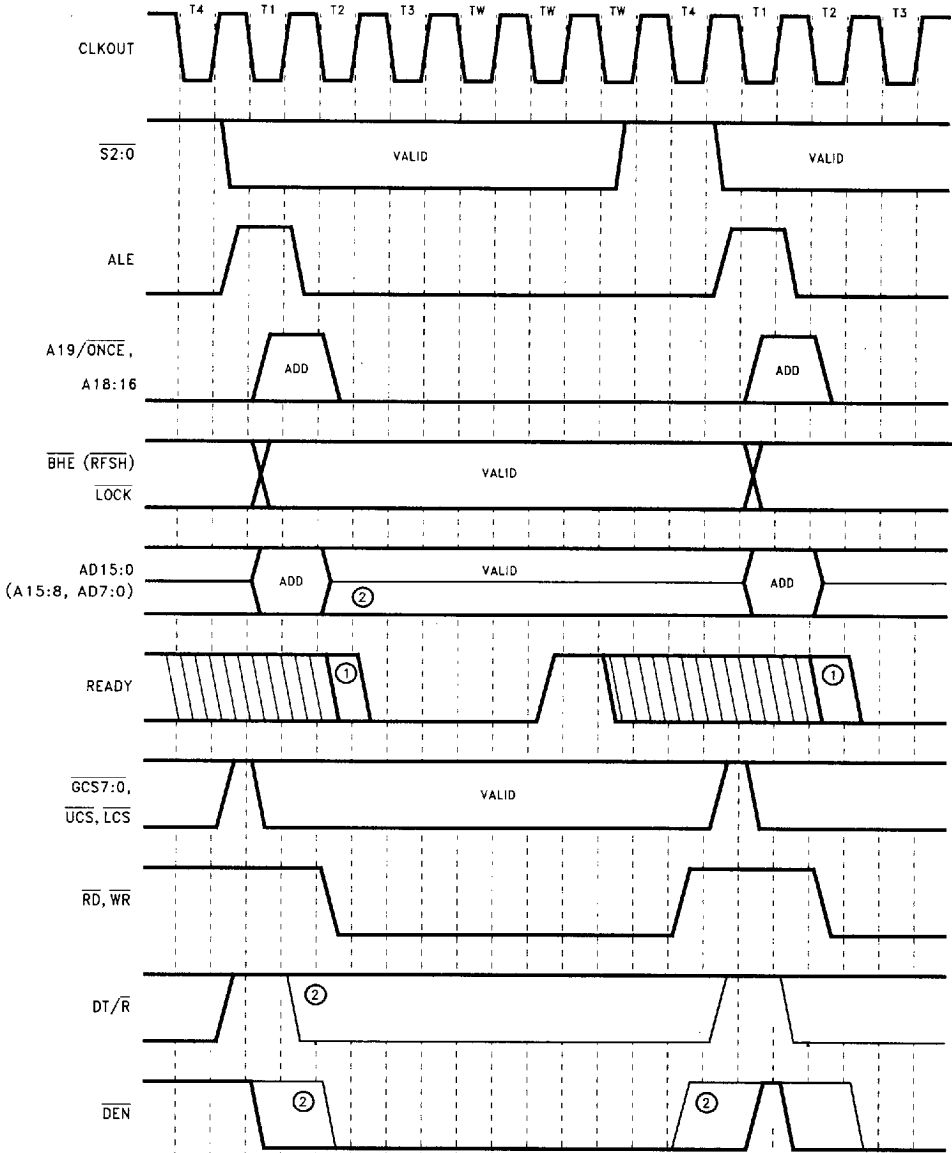

Figure 23. Refresh during HLDA Waveforms



272434-23

NOTES:

- 1. READY must be low by either edge to cause a wait state.
 - 2. Lighter lines indicate READ cycles, darker lines indicate WRITE cycles.
- Pin names in parentheses apply to 80C188EC/80L188EC.

Figure 24. READY Cycle Waveforms

80C186EC/80C188EC EXECUTION TIMINGS

A determination of program execution timing must consider the bus cycles necessary to prefetch instructions as well as the number of execution unit cycles necessary to execute instructions. The following instruction timings represent the **minimum** execution time in clock cycles for each instruction. The timings given are based on the following assumptions:

- The opcode, along with any data or displacement required for execution of a particular instruction, has been prefetched and resides in the queue at the time it is needed.
- No wait states or bus HOLDs occur.
- All word-data is located on even-address boundaries (80C186EC only).

All jumps and calls include the time required to fetch the opcode of the next instruction at the destination address.

All instructions which involve memory accesses can require one or two additional clocks above the minimum timings shown due to the asynchronous handshake between the bus interface unit (BIU) and execution unit.

With a 16-bit BIU, the 80C186EC has sufficient bus performance to ensure that an adequate number of prefetched bytes will reside in the queue (6 bytes) most of the time. Therefore, actual program execution time will not be substantially greater than that derived from adding the instruction timings shown.

The 80C188EC 8-bit BIU is limited in its performance relative to the execution unit. A sufficient number of prefetched bytes may not reside in the prefetch queue (4 bytes) much of the time. Therefore, actual program execution time will be substantially greater than that derived from adding the instruction timings shown.

INSTRUCTION SET SUMMARY

Function	Format	80C186EC Clock Cycles	80C188EC Clock Cycles	Comments
DATA TRANSFER				
MOV = Move:				
Register to Register/Memory	1 0 0 0 1 0 0 w mod reg r/m	2/12	2/12*	
Register/memory to register	1 0 0 0 1 0 1 w mod reg r/m	2/9	2/9*	
Immediate to register/memory	1 1 0 0 0 1 1 w mod 000 r/m data data if w = 1	12/13	12/13	8/16-bit
Immediate to register	1 0 1 1 w reg data data if w = 1	3/4	3/4	8/16-bit
Memory to accumulator	1 0 1 0 0 0 0 w addr-low addr-high	8	8*	
Accumulator to memory	1 0 1 0 0 0 1 w addr-low addr-high	9	9*	
Register/memory to segment register	1 0 0 0 1 1 1 0 mod 0 reg r/m	2/9	2/13	
Segment register to register/memory	1 0 0 0 1 1 0 0 mod 0 reg r/m	2/11	2/15	
PUSH = Push:				
Memory	1 1 1 1 1 1 1 1 mod 1 1 0 r/m	16	20	
Register	0 1 0 1 0 reg	10	14	
Segment register	0 0 0 reg 1 1 0	9	13	
Immediate	0 1 1 0 1 0 s 0 data data if s = 0	10	14	
PUSHA = Push All				
	0 1 1 0 0 0 0 0	36	66	
POP = Pop:				
Memory	1 0 0 0 1 1 1 1 mod 0 0 0 r/m	20	24	
Register	0 1 0 1 1 reg	10	14	
Segment register	0 0 0 reg 1 1 1 (reg ≠ 01)	8	12	
POPA = Pop All				
	0 1 1 0 0 0 0 1	61	83	
XCHG = Exchange:				
Register/memory with register	1 0 0 0 0 1 1 w mod reg r/m	4/17	4/17*	
Register with accumulator	1 0 0 1 0 reg	3	3	
IN = Input from:				
Fixed port	1 1 1 0 0 1 0 w port	10	10*	
Variable port	1 1 1 0 1 1 0 w	8	8*	
OUT = Output to:				
Fixed port	1 1 1 0 0 1 1 w port	9	9*	
Variable port	1 1 1 0 1 1 1 w	7	7*	
XLAT = Translate byte to AL	1 1 0 1 0 1 1 1	11	15	
LEA = Load EA to register	1 0 0 0 1 1 0 1 mod reg r/m	6	6	
LDS = Load pointer to DS	1 1 0 0 0 1 0 1 mod reg r/m	18	26	(mod ≠ 11)
LES = Load pointer to ES	1 1 0 0 0 1 0 0 mod reg r/m	18	26	(mod ≠ 11)
LAHF = Load AH with flags	1 0 0 1 1 1 1 1	2	2	
SAHF = Store AH into flags	1 0 0 1 1 1 1 0	3	3	
PUSHF = Push flags	1 0 0 1 1 1 0 0	9	13	
POPF = Pop flags	1 0 0 1 1 1 0 1	8	12	

Shaded areas indicate instructions not available in 8086/8088 microsystems.

NOTE:

*Clock cycles shown for byte transfers, for word operations, add 4 clock cycles for all memory transfers.

1

INSTRUCTION SET SUMMARY (Continued)

Function	Format	80C186EC Clock Cycles	80C188EC Clock Cycles	Comments
DATA TRANSFER (Continued)				
SEGMENT = Segment Override:				
CS	00101110	2	2	
SS	00110110	2	2	
DS	00111110	2	2	
ES	00100110	2	2	
ARITHMETIC				
ADD = Add:				
Reg./memory with register to either	000000d w mod reg r/m	3/10	3/10*	
Immediate to register/memory	100000s w mod 000 r/m data data if s w = 01	4/16	4/16*	
Immediate to accumulator	000010w data data if w = 1	3/4	3/4	8/16-bit
ADC = Add with carry:				
Reg./memory with register to either	000100d w mod reg r/m	3/10	3/10*	
Immediate to register/memory	100000s w mod 010 r/m data data if s w = 01	4/16	4/16*	
Immediate to accumulator	000101w data data if w = 1	3/4	3/4	8/16-bit
INC = Increment:				
Register/memory	1111111w mod 000 r/m	3/15	3/15*	
Register	01000 reg	3	3	
SUB = Subtract:				
Reg./memory and register to either	001010d w mod reg r/m	3/10	3/10*	
Immediate from register/memory	100000s w mod 101 r/m data data if s w = 01	4/16	4/16*	
Immediate from accumulator	001011w data data if w = 1	3/4	3/4*	8/16-bit
SBB = Subtract with borrow:				
Reg./memory and register to either	000110d w mod reg r/m	3/10	3/10*	
Immediate from register/memory	100000s w mod 011 r/m data data if s w = 01	4/16	4/16*	
Immediate from accumulator	000111w data data if w = 1	3/4	3/4*	8/16-bit
DEC = Decrement				
Register/memory	1111111w mod 001 r/m	3/15	3/15*	
Register	01001 reg	3	3	
CMP = Compare:				
Register/memory with register	0011101w mod reg r/m	3/10	3/10*	
Register with register/memory	0011100w mod reg r/m	3/10	3/10*	
Immediate with register/memory	100000s w mod 111 r/m data data if s w = 01	3/10	3/10*	
Immediate with accumulator	0011110w data data if w = 1	3/4	3/4	8/16-bit
NEG = Change sign register/memory				
	1111011w mod 011 r/m	3/10	3/10*	
AAA = ASCII adjust for add				
	00110111	8	8	
DAA = Decimal adjust for add				
	00100111	4	4	
AAS = ASCII adjust for subtract				
	00111111	7	7	
DAS = Decimal adjust for subtract				
	00101111	4	4	
MUL = Multiply (unsigned):				
Register-Byte	1111011w mod 100 r/m	26-28	25-28	
Register-Word		35-37	35-37	
Memory-Byte		32-34	32-34	
Memory-Word		41-43	41-43*	

Shaded areas indicate instructions not available in 8086/8088 microsystems.

NOTE:

*Clock cycles shown for byte transfers, for word operations, add 4 clock cycles for all memory transfers.

INSTRUCTION SET SUMMARY (Continued)

Function	Format	80C186EC Clock Cycles	80C188EC Clock Cycles	Comments				
ARITHMETIC (Continued)								
IMUL = Integer multiply (signed):	<table border="1"><tr><td>1111011w</td><td>mod 101 r/m</td></tr></table>	1111011w	mod 101 r/m					
1111011w	mod 101 r/m							
Register-Byte		25-28	25-28					
Register-Word		34-37	34-37					
Memory-Byte		31-34	32-34					
Memory-Word		40-43	40-43*					
IMUL = Integer immediate multiply (signed)	<table border="1"><tr><td>011010s1</td><td>mod reg r/m</td><td>data</td><td>data if s=0</td></tr></table>	011010s1	mod reg r/m	data	data if s=0	22-25/ 29-32	22-25/ 29-32	
011010s1	mod reg r/m	data	data if s=0					
DIV = Divide (unsigned):	<table border="1"><tr><td>1111011w</td><td>mod 110 r/m</td></tr></table>	1111011w	mod 110 r/m					
1111011w	mod 110 r/m							
Register-Byte		29	29					
Register-Word		38	38					
Memory-Byte		35	35					
Memory-Word		44	44*					
IDIV = Integer divide (signed):	<table border="1"><tr><td>1111011w</td><td>mod 111 r/m</td></tr></table>	1111011w	mod 111 r/m					
1111011w	mod 111 r/m							
Register-Byte		44-52	44-52					
Register-Word		53-61	53-61					
Memory-Byte		50-58	50-58					
Memory-Word		59-67	59-67*					
AAM = ASCII adjust for multiply	<table border="1"><tr><td>11010100</td><td>00001010</td></tr></table>	11010100	00001010	19	19			
11010100	00001010							
AAD = ASCII adjust for divide	<table border="1"><tr><td>11010101</td><td>00001010</td></tr></table>	11010101	00001010	15	15			
11010101	00001010							
CBW = Convert byte to word	<table border="1"><tr><td>10011000</td></tr></table>	10011000	2	2				
10011000								
CWD = Convert word to double word	<table border="1"><tr><td>10011001</td></tr></table>	10011001	4	4				
10011001								
LOGIC								
Shift/Rotate Instructions:								
Register/Memory by 1	<table border="1"><tr><td>1101000w</td><td>mod TTT r/m</td></tr></table>	1101000w	mod TTT r/m	2/15	2/15			
1101000w	mod TTT r/m							
Register/Memory by CL	<table border="1"><tr><td>1101001w</td><td>mod TTT r/m</td></tr></table>	1101001w	mod TTT r/m	5+n/17+n	5+n/17+n			
1101001w	mod TTT r/m							
Register/Memory by Count	<table border="1"><tr><td>1100000w</td><td>mod TTT r/m</td><td>count</td></tr></table>	1100000w	mod TTT r/m	count	5+n/17+n	5+n/17+n		
1100000w	mod TTT r/m	count						
	TTT Instruction							
	000 ROL							
	001 ROR							
	010 RCL							
	011 RCR							
	100 SHL/SAL							
	101 SHR							
	111 SAR							
AND = And:								
Reg/memory and register to either	<table border="1"><tr><td>001000dw</td><td>mod reg r/m</td></tr></table>	001000dw	mod reg r/m	3/10	3/10*			
001000dw	mod reg r/m							
Immediate to register/memory	<table border="1"><tr><td>1000000w</td><td>mod 100 r/m</td><td>data</td><td>data if w=1</td></tr></table>	1000000w	mod 100 r/m	data	data if w=1	4/16	4/16*	
1000000w	mod 100 r/m	data	data if w=1					
Immediate to accumulator	<table border="1"><tr><td>0010010w</td><td>data</td><td>data if w=1</td></tr></table>	0010010w	data	data if w=1	3/4	3/4*	8/16-bit	
0010010w	data	data if w=1						
TEST = And function to flags, no result:								
Register/memory and register	<table border="1"><tr><td>1000010w</td><td>mod reg r/m</td></tr></table>	1000010w	mod reg r/m	3/10	3/10			
1000010w	mod reg r/m							
Immediate data and register/memory	<table border="1"><tr><td>1111011w</td><td>mod 000 r/m</td><td>data</td><td>data if w=1</td></tr></table>	1111011w	mod 000 r/m	data	data if w=1	4/10	4/10*	
1111011w	mod 000 r/m	data	data if w=1					
Immediate data and accumulator	<table border="1"><tr><td>1010100w</td><td>data</td><td>data if w=1</td></tr></table>	1010100w	data	data if w=1	3/4	3/4	8/16-bit	
1010100w	data	data if w=1						
OR = Or:								
Reg/memory and register to either	<table border="1"><tr><td>000010dw</td><td>mod reg r/m</td></tr></table>	000010dw	mod reg r/m	3/10	3/10*			
000010dw	mod reg r/m							
Immediate to register/memory	<table border="1"><tr><td>1000000w</td><td>mod 001 r/m</td><td>data</td><td>data if w=1</td></tr></table>	1000000w	mod 001 r/m	data	data if w=1	4/16	4/16*	
1000000w	mod 001 r/m	data	data if w=1					
Immediate to accumulator	<table border="1"><tr><td>0000110w</td><td>data</td><td>data if w=1</td></tr></table>	0000110w	data	data if w=1	3/4	3/4*	8/16-bit	
0000110w	data	data if w=1						

Shaded areas indicate instructions not available in 8086/8088 microsystems.

NOTE:

*Clock cycles shown for byte transfers, for word operations, add 4 clock cycles for all memory transfers.

INSTRUCTION SET SUMMARY (Continued)

Function	Format	80C186EC Clock Cycles	80C188EC Clock Cycles	Comments
LOGIC (Continued)				
XOR = Exclusive or:				
Reg/memory and register to either	001100dw mod reg r/m	3/10	3/10*	
Immediate to register/memory	1000000w mod 110 r/m data data if w = 1	4/16	4/16*	
Immediate to accumulator	0011010w data data if w = 1	3/4	3/4	8/16-bit
NOT = Invert register/memory	1111011w mod 010 r/m	3/10	3/10*	
STRING MANIPULATION				
MOVS = Move byte/word	1010010w	14	14*	
CMPS = Compare byte/word	1010011w	22	22*	
SCAS = Scan byte/word	1010111w	15	15*	
LODS = Load byte/wd to AL/AX	1010110w	12	12*	
STOS = Store byte/wd from AL/AX	1010101w	10	10*	
INS = Input byte/wd from DX port	0110110w	14	14	
OUTS = Output byte/wd to DX port	0110111w	14	14	
Repeated by count in CX (REP/REPE/REPZ/REPNE/REPNZ)				
MOVS = Move string	11110010 1010010w	8+8n	8+8n*	
CMPS = Compare string	1111001z 1010011w	5+22n	5+22n*	
SCAS = Scan string	1111001z 1010111w	5+15n	5+15n*	
LODS = Load string	11110010 1010110w	6+11n	6+11n*	
STOS = Store string	11110010 1010101w	6+9n	6+9n*	
INS = Input string	11110010 0110110w	8+8n	8+8n*	
OUTS = Output string	11110010 0110111w	8+8n	8+8n*	
CONTROL TRANSFER				
CALL = Call:				
Direct within segment	11101000 disp-low disp-high	15	19	
Register/memory indirect within segment	11111111 mod 010 r/m	13/19	17/27	
Direct intersegment	10011010 segment offset segment selector	23	31	
Indirect intersegment	11111111 mod 011 r/m (mod ≠ 11)	38	54	
JMP = Unconditional jump:				
Short/long	11101011 disp-low	14	14	
Direct within segment	11101001 disp-low disp-high	14	14	
Register/memory indirect within segment	11111111 mod 100 r/m	11/17	11/21	
Direct intersegment	11101010 segment offset segment selector	14	14	
Indirect intersegment	11111111 mod 101 r/m (mod ≠ 11)	26	34	

Shaded areas indicate instructions not available in 8086/8088 microsystems.

NOTE:

*Clock cycles shown for byte transfers, for word operations, add 4 clock cycles for all memory transfers.

INSTRUCTION SET SUMMARY (Continued)

Function	Format	80C186EC Clock Cycles	80C188EC Clock Cycles	Comments	
CONTROL TRANSFER (Continued)					
RET = Return from CALL:					
Within segment	11000011	16	20		
Within seg adding immed to SP	11000010 data-low data-high	18	22		
Intersegment	11001011	22	30		
Intersegment adding immediate to SP	11001010 data-low data-high	25	33		
JE/JZ = Jump on equal/zero	01110100 disp	4/13	4/13	JMP not taken/JMP taken	
JL/JNGE = Jump on less/not greater or equal	01111100 disp	4/13	4/13		
JLE/JNGQ = Jump on less or equal/not greater	01111110 disp	4/13	4/13		
JB/JNAE = Jump on below/not above or equal	01110010 disp	4/13	4/13		
JBE/JNA = Jump on below or equal/not above	01110110 disp	4/13	4/13		
JP/JPE = Jump on parity/parity even	01111010 disp	4/13	4/13		
JO = Jump on overflow	01110000 disp	4/13	4/13		
JS = Jump on sign	01111000 disp	4/13	4/13		
JNE/JNZ = Jump on not equal/not zero	01110101 disp	4/13	4/13		
JNL/JGE = Jump on not less/greater or equal	01111101 disp	4/13	4/13		
JNLE/JG = Jump on not less or equal/greater	01111111 disp	4/13	4/13		
JNB/JAE = Jump on not below/above or equal	01110011 disp	4/13	4/13		
JNBE/JA = Jump on not below or equal/above	01110111 disp	4/13	4/13		
JNP/JPO = Jump on not par/par odd	01111011 disp	4/13	4/13		
JNO = Jump on not overflow	01110001 disp	4/13	4/13		
JNS = Jump on not sign	01111001 disp	4/13	4/13		
JCXZ = Jump on CX zero	11100011 disp	5/15	5/15		
LOOP = Loop CX times	11100010 disp	6/16	6/16		LOOP not taken/LOOP taken
LOOPZ/LOOPE = Loop while zero/equal	11100001 disp	6/16	6/16		
LOOPNZ/LOOPNE = Loop while not zero/equal	11100000 disp	6/16	6/16		
ENTER = Enter Procedure	11001000 data-low data-high L				
L = 0		15	19		
L = 1		25	29		
L > 1		22 + 16(n - 1)	26 + 20(n - 1)		
LEAVE = Leave Procedure	11001001	6	8		
INT = Interrupt:					
Type specified	11001101 type	47	47	if INT. taken/ if INT. not taken	
Type 3	11001100	45	45		
INTO = Interrupt on overflow	11001110	48/4	48/4		
IRET = Interrupt return	11001111	28	28		
BOUND = Detect value out of range	01100010 mod reg. r/m	33-35	33-35		

Shaded areas indicate instructions not available in 8086/8088 microsystems.

NOTE:

*Clock cycles shown for byte transfers, for word operations, add 4 clock cycles for all memory transfers.

1

PRELIMINARY

4826175 0162100 104

1-243

INSTRUCTION SET SUMMARY (Continued)

Function	Format	80C186EC Clock Cycles	80C188EC Clock Cycles	Comments
PROCESSOR CONTROL				
CLC = Clear carry	11111000	2	2	
CMC = Complement carry	11110101	2	2	
STC = Set carry	11111001	2	2	
CLD = Clear direction	11111100	2	2	
STD = Set direction	11111101	2	2	
CLI = Clear interrupt	11111010	2	2	
STI = Set interrupt	11111011	2	2	
HLT = Halt	11110100	2	2	
WAIT = Wait	10011011	6	6	if TEST = 0
LOCK = Bus lock prefix	11110000	2	2	
NOP = No Operation	10010000	3	3	

(TTT LLL are opcode to processor extension)

Shaded areas indicate instructions not available in 8086/8088 microsystems.

NOTE:

*Clock cycles shown for byte transfers, for word operations, add 4 clock cycles for all memory transfers.

The Effective Address (EA) of the memory operand is computed according to the mod and r/m fields:

if mod = 11 then r/m is treated as a REG field

if mod = 00 then DISP = 0*, disp-low and disp-high are absent

if mod = 01 then DISP = disp-low sign-extended to 16-bits, disp-high is absent

if mod = 10 then DISP = disp-high: disp-low

if r/m = 000 then EA = (BX) + (SI) + DISP

if r/m = 001 then EA = (BX) + (DI) + DISP

if r/m = 010 then EA = (BP) + (SI) + DISP

if r/m = 011 then EA = (BP) + (DI) + DISP

if r/m = 100 then EA = (SI) + DISP

if r/m = 101 then EA = (DI) + DISP

if r/m = 110 then EA = (BP) + DISP*

if r/m = 111 then EA = (BX) + DISP

DISP follows 2nd byte of instruction (before data if required)

*except if mod = 00 and r/m = 110 then EA = disp-high: disp-low.

EA calculation time is 4 clock cycles for all modes, and is included in the execution times given whenever appropriate.

Segment Override Prefix

0 0 1 reg 1 1 0

reg is assigned according to the following:

reg	Segment Register
00	ES
01	CS
10	SS
11	DS

REG is assigned according to the following table:

16-Bit (w = 1)	8-Bit (w = 0)
000 AX	000 AL
001 CX	001 CL
010 DX	010 DL
011 BX	011 BL
100 SP	100 AH
101 BP	101 CH
110 SI	110 DH
111 DI	111 BH

The physical addresses of all operands addressed by the BP register are computed using the SS segment register. The physical addresses of the destination operands of the string primitive operations (those addressed by the DI register) are computed using the ES segment, which may not be overridden.



ERRATA

An 80C186EC/80L186EC with a STEPID value of 0002H has no known errata. A device with a STEPID of 0002H can be visually identified by noting the **presence** of an "A" or "B" alpha character next to the FPO number or the absence of any alpha character. The FPO number location is shown in Figures 4, 5 and 6.

REVISION HISTORY

This data sheet replaces the following data sheets:

- 272072-003 80C186EC
- 272076-003 80C188EC
- 272332-001 80L186EC
- 272333-001 80L188EC
- 272373-001 SB80C188EC/SB80L188EC
- 272372-001 SB80C186EC/SB80L186EC

