

2N2219

Features

- Meets MIL 19500 /251
- Collector - Base Voltage 60 V
- Collector - Current 800 mA
- Medium Current, Bipolar Transistor

**SWITCHING
 TRANSISTOR
 JAN, JANTX, JANTXV**

**SMALL SIGNAL
 BIPOLAR
 NPN SILICON**

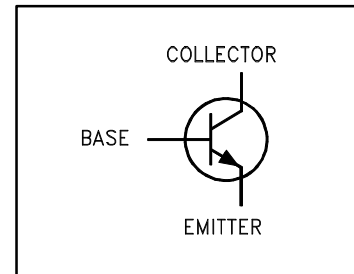
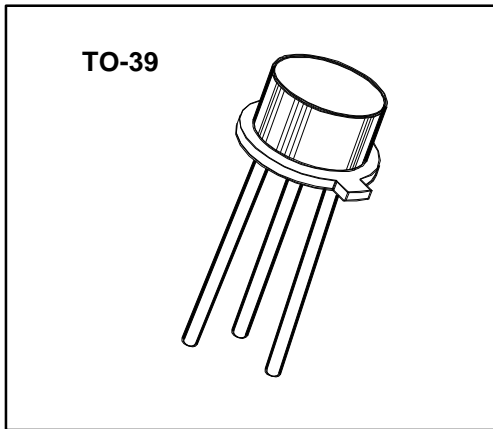

Maximum Ratings

RATING	SYMBOL	VALUE	UNIT
Collector - Emitter Voltage	V_{CEO}	30	Vdc
Collector - Base Voltage	V_{CBO}	60	Vdc
Emitter - Base Voltage	V_{EBO}	5	Vdc
Collector Current - Continuous	I_C	800	mAdc
Total Device Dissipation @ $T_A = 25\text{ }^\circ\text{C}$	P_D	0.8	WATTS
Derate above $25\text{ }^\circ\text{C}$		4.6	mW/ $^\circ\text{C}$
Total Device Dissipation @ $T_C = 25\text{ }^\circ\text{C}$	P_D	3.0	WATTS
Derate above $25\text{ }^\circ\text{C}$		17.0	mW/ $^\circ\text{C}$
Operating Junction & Storage Temperature Range	T_J, T_{stg}	-55 to +200	$^\circ\text{C}$

Thermal Characteristics

CHARACTERISTIC	SYMBOL	MAX	UNIT
Thermal Resistance, Junction to Ambient	$R\theta_{JA}$	217	$^\circ\text{C/W}$
Thermal Resistance, Junction to Case	$R\theta_{JC}$	59	$^\circ\text{C/W}$

2N2219

Electrical Characteristics ($T_A = 25^\circ\text{C}$ unless otherwise noted)

OFF CHARACTERISTIC	SYMBOL	MIN	MAX	UNIT
Collector - Emitter Breakdown Voltage (1) ($I_C = 10 \text{ mA dc}, I_B = 0$)	$V(\text{BR})_{\text{CEO}}$	30		Vdc
Collector - Base Breakdown Voltage ($I_C = 10 \mu\text{Adc}, I_E = 0$)	$V(\text{BR})_{\text{CBO}}$	60		Vdc
Emitter - Base Breakdown Voltage ($I_E = 10 \mu\text{Adc}, I_C = 0$)	$V(\text{BR})_{\text{EBO}}$	5		Vdc
Collector - Emitter Cutoff Current ($V_{\text{CE}} = 30 \text{ Vdc}$)	I_{CES}		10	nAdc
Collector - Base Cutoff Current ($V_{\text{CB}} = 50 \text{ Vdc}, I_E = 0$)	I_{CBO}		10	nAdc
			10	μAdc
Emitter - Base Cutoff Current ($V_{\text{EB}} = 4 \text{ Vdc}$)	I_{EBO}		10	nAdc
			10	μAdc

ON CHARACTERISTIC	SYMBOL	MIN	MAX	UNIT
DC Current Gain	h_{FE}			
($I_C = 0.1 \text{ mA dc}, V_{\text{CE}} = 10 \text{ Vdc}$) (1)		35		
($I_C = 1 \text{ mA dc}, V_{\text{CE}} = 10 \text{ Vdc}$) (1)		50	325	
($I_C = 10 \text{ mA dc}, V_{\text{CE}} = 10 \text{ Vdc}$) (1)		75		
($I_C = 150 \text{ mA dc}, V_{\text{CE}} = 10 \text{ Vdc}$) (1)		100	300	
($I_C = 500 \text{ mA dc}, V_{\text{CE}} = 10 \text{ Vdc}$) (1)		30		
($I_C = 10 \text{ mA dc}, V_{\text{CE}} = 10 \text{ Vdc}, T_J = -55^\circ\text{C}$) (1)		15		
Collector - Emitter Saturation Voltage ($I_C = 150 \text{ mAdc}, I_B = 15 \text{ mAdc}$) (1)	$V_{\text{CE}(\text{sat})}$		0.4	Vdc
($I_C = 500 \text{ mAdc}, I_B = 50 \text{ mAdc}$) (1)			1.6	Vdc
Base - Emitter Saturation Voltage ($I_C = 150 \text{ mAdc}, I_B = 15 \text{ mAdc}$) (1)	$V_{\text{BE}(\text{sat})}$	0.6	1.3	Vdc
($I_C = 500 \text{ mAdc}, I_B = 50 \text{ mAdc}$) (1)			2.6	Vdc

1. Pulse Test: Pulse Width $\leq 300 \mu\text{s}$, Duty Cycle $\leq 2\%$

2N2219

Electrical Characteristics ($T_A = 25^\circ\text{C}$ unless otherwise noted)

SMALL - SIGNAL CHARACTERISTICS	SYMBOL	MIN	MAX	UNIT
Output Capacitance	C_{obo}			
($V_{CB} = 10 \text{ Vdc}$, $I_E = 0$, $100\text{kHz} \leq f \leq 1 \text{ MHz}$)			8.0	pF
Input Capacitance	C_{ibo}			
($V_{EB} = 0.5 \text{ Vdc}$, $I_C = 0$, $100\text{kHz} \leq f \leq 1 \text{ MHz}$)			25	pF

SWITCHING CHARACTERISTICS	SYMBOL	MIN	MAX	UNIT
Turn - On Time	t_{on}			
($V_{CC} = 30 \text{ Vdc}$, $I_C = 150 \text{ mAdc}$, $I_{B1} = 15 \text{ mAdc}$) (See FIGURE 1)			40	ns
Turn - Off Time	t_{off}			
($V_{CC} = 30 \text{ Vdc}$, $I_C = 150 \text{ mAdc}$, $I_{B1} = - I_{B2} = 15 \text{ mAdc}$) (See FIGURE 2)			250	ns

Small - Signal AC Characteristics ($T_A = 25^\circ\text{C}$)

LOW FREQUENCY	SYMBOL	MIN	MAX	UNIT
Common - Emitter Forward Current Transfer Ratio	h_{fe}			
($I_C = 1 \text{ mA}$, $V_{CE} = 10 \text{ V}$, $f = 1\text{kHz}$)		50		
HIGH FREQUENCY				
Common - Emitter Forward Current Transfer Ratio	$ h_{fe} $			
($I_C = 20 \text{ mA}$, $V_{CE} = 20 \text{ V}$, $f = 100 \text{ MHz}$)		2.5	12	

Spice Model (based upon typical device characteristics) *1

Q2N2219 NPN (IS = 21.2f XTI = 3.0 EG = 1.11 VAF = 157.4 BF = 196.6 ISE = 67.07 f
 + NE = 1.6 IKF = 1.537 NK = 1.02 XTB = 1.5 BR = 1.0 ISC = 1.709 p
 + NC = 1.437 IKR = 0.9876 RC = 0.0 CJC = 19.4p MJC = 0.3333 VJC = 0.75
 + FC = 0.5 CJE = 29.6p MJE = 0.3333 VJE = 0.75 TR = 300.2 n TF = 562.6p
 + ITF = 1.0 XTF = 0.0 VTF = 10.0)

*1. Microsemi Corp. claims no responsibility for misapplication of Spice Model information. Spice modeling should be used as a precursor guide to in-circuit performance. Actual performance is the responsibility of the user/designer.

2N2219

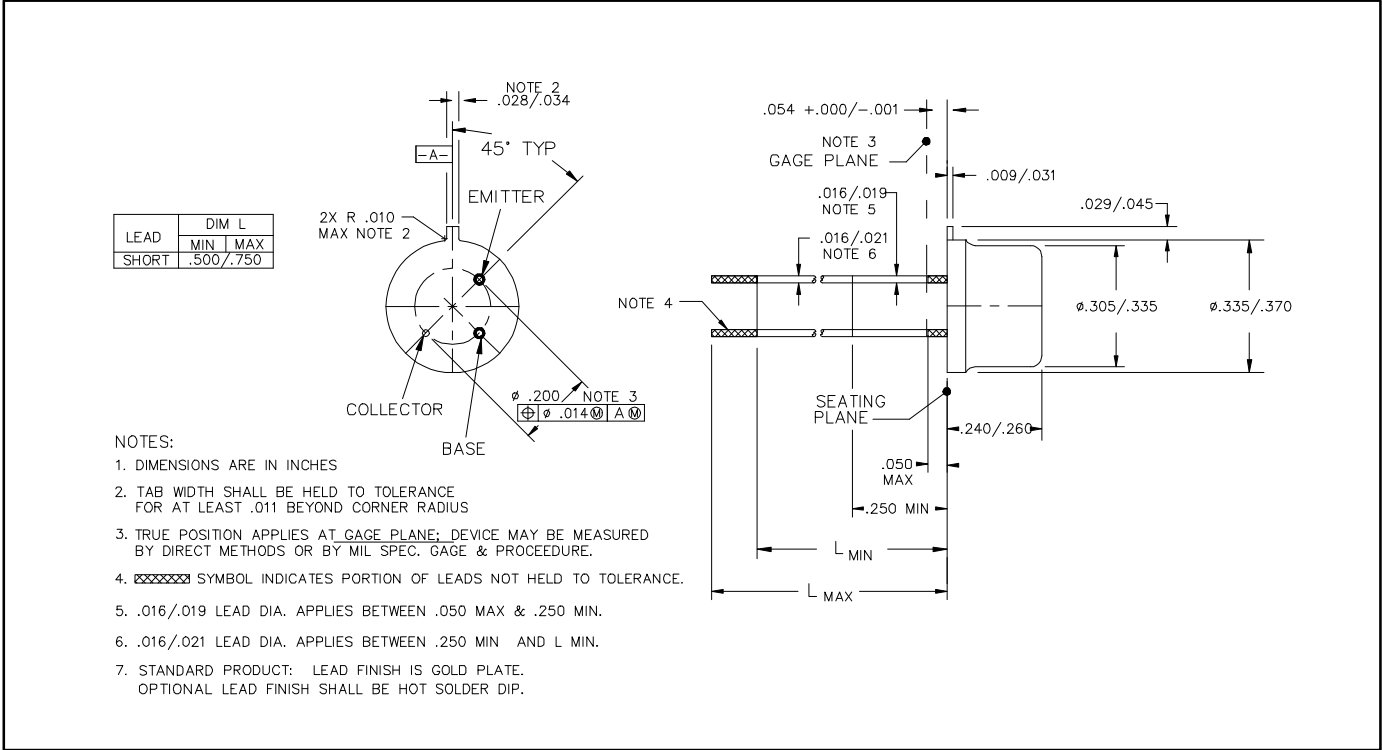

TO-39 CASE OUTLINE

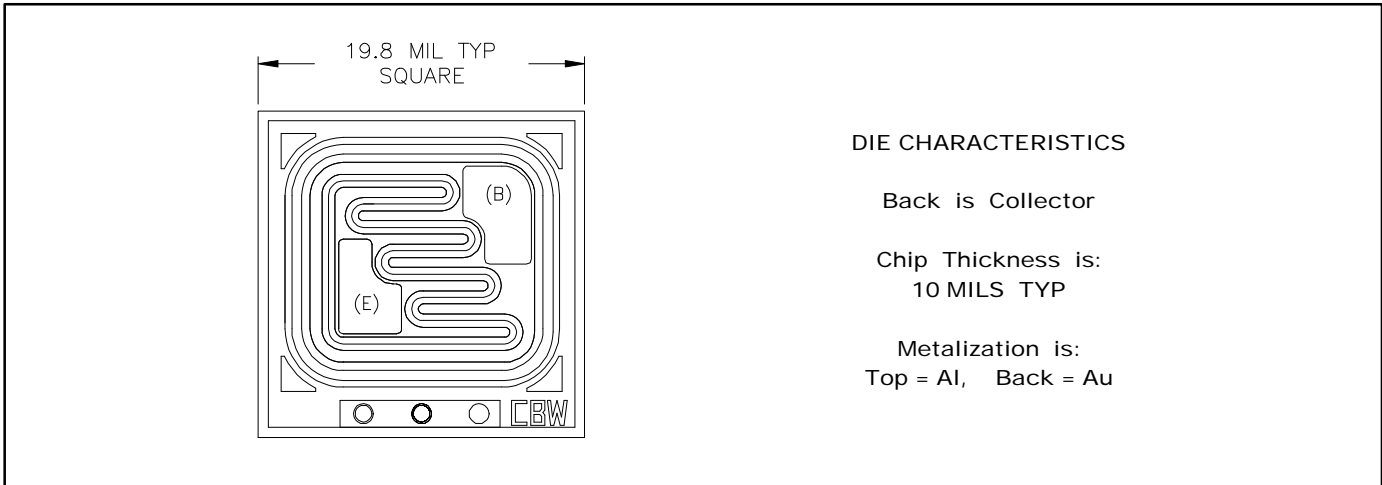

DIE OUTLINE

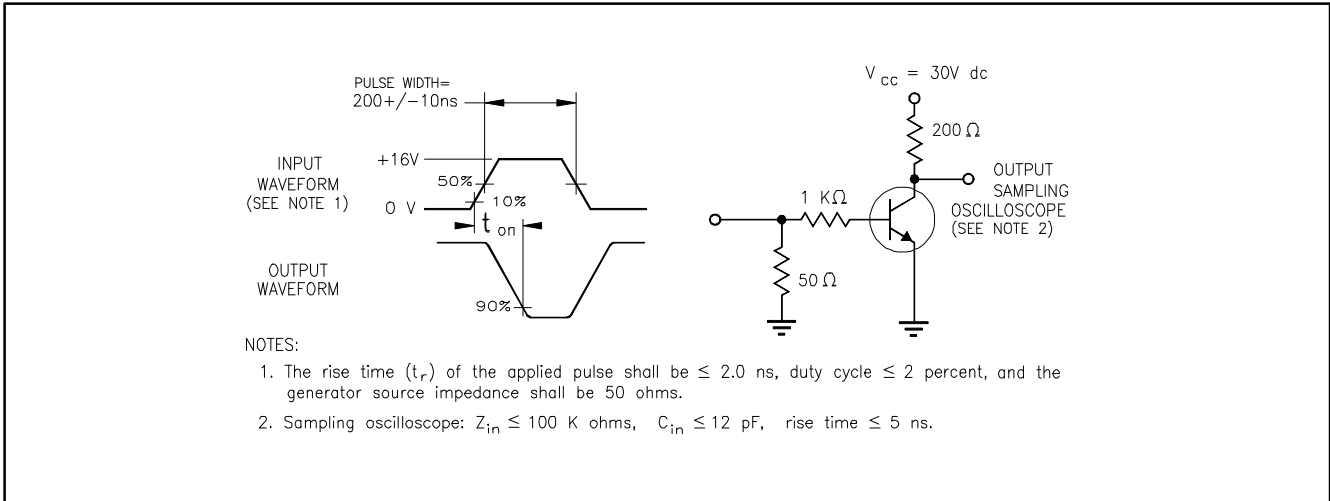

FIGURE 1 Saturated Turn-on Time Test Circuit

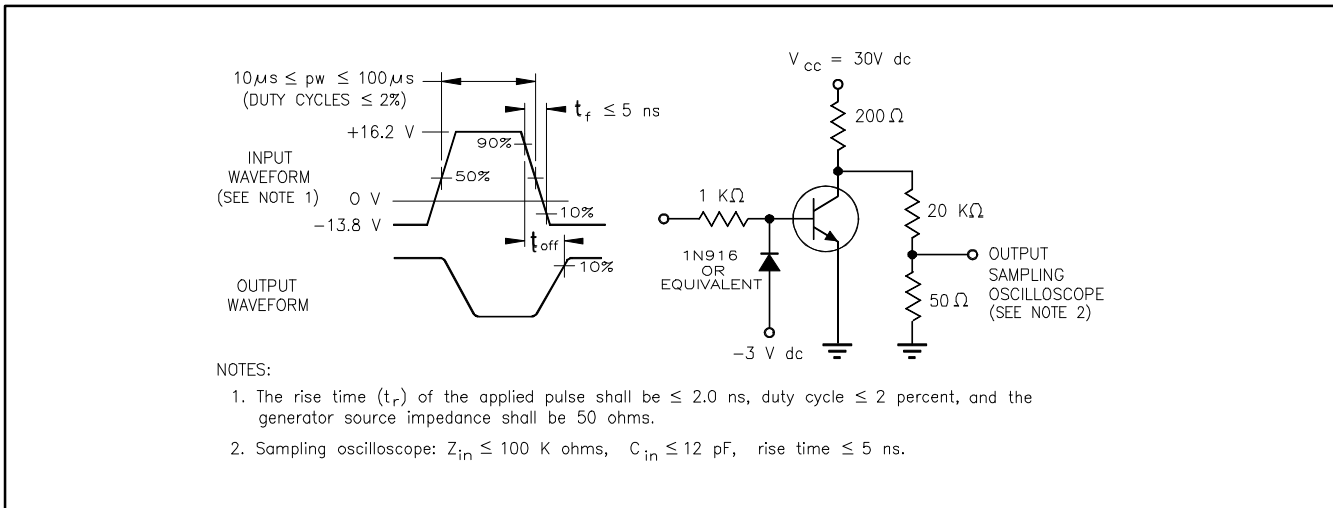

FIGURE 2 Saturated Turn-off Time Test Circuit

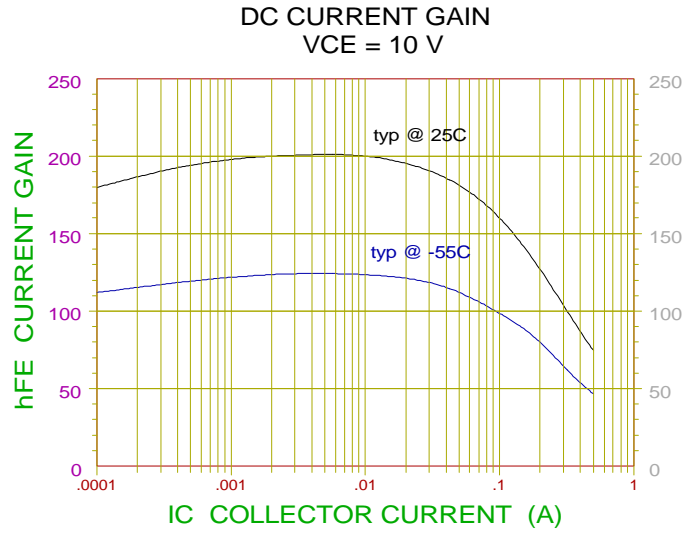

FIGURE 3

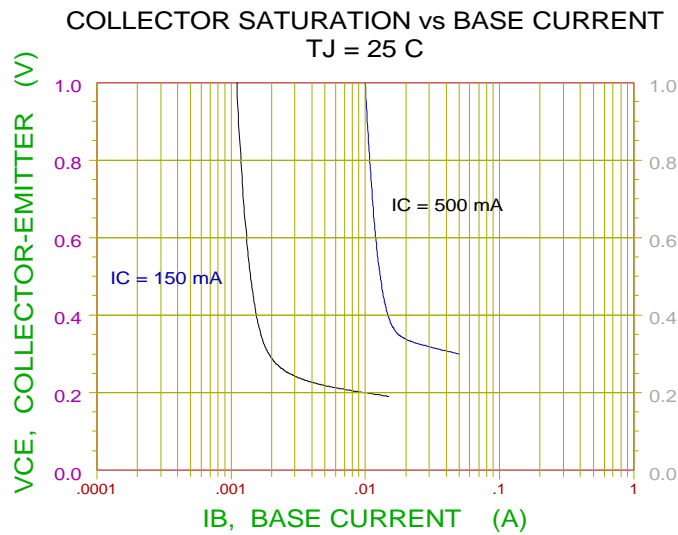

FIGURE 4

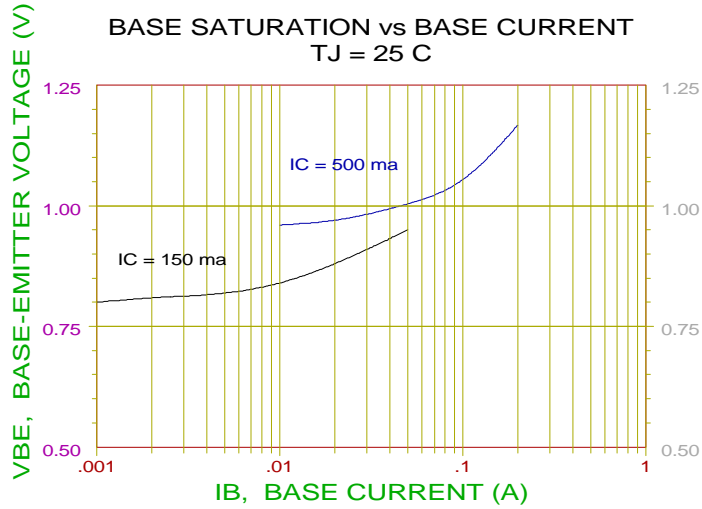

FIGURE 5

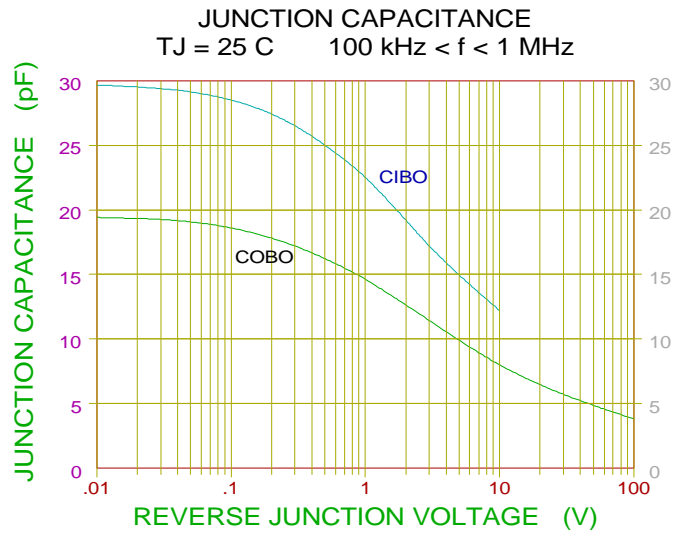

FIGURE 6

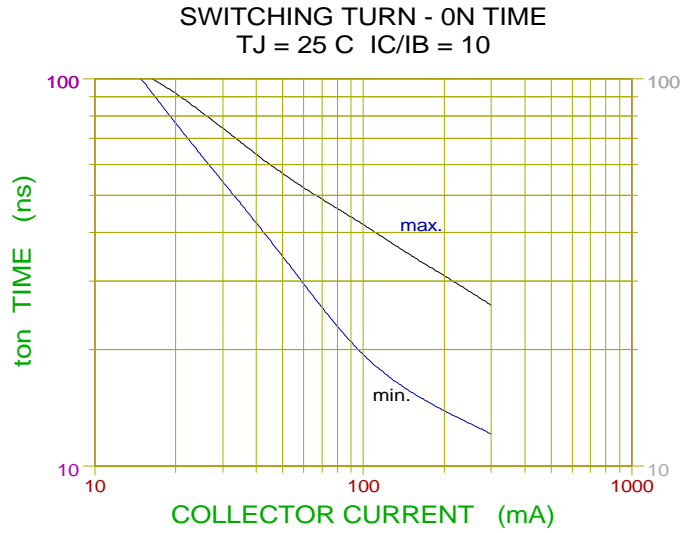

FIGURE 7

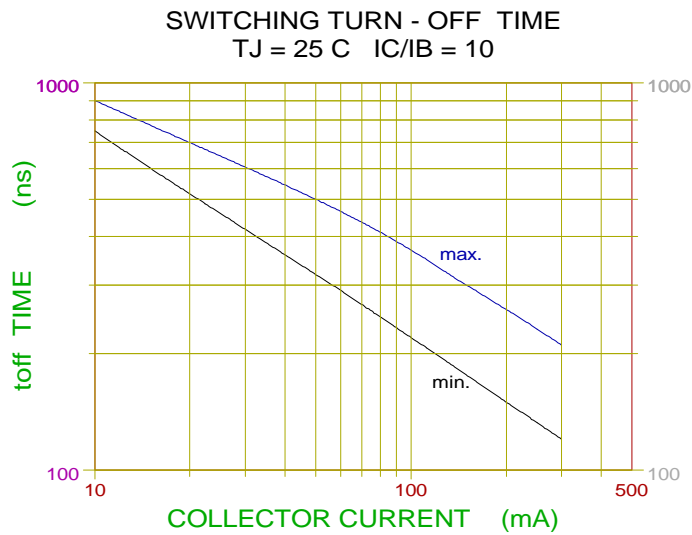

FIGURE 8

2N2219

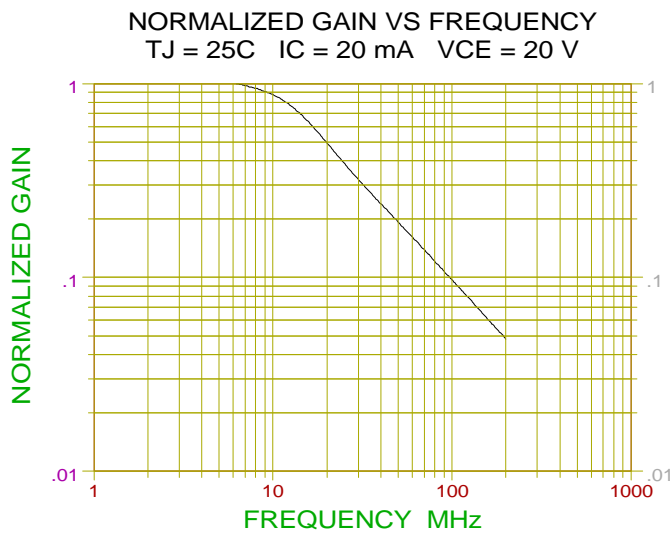

FIGURE 9