

**3A LOW DROPOUT POSITIVE  
 FIXED 3.3V REGULATOR**

**FEATURES**

- Guaranteed < 1.3V Dropout at Full Load Current
- Fast Transient Response
- 1% Voltage Reference Initial Accuracy
- Output Current Limiting
- Built-In Thermal Shutdown

**APPLICATIONS**

- Standard 3.3V Chip Set and Logic Applications

**DESCRIPTION**

The IRU1030-33 is a low dropout three-terminal fixed 3.3V output regulator with minimum of 3A output current capability. This product is specifically designed to provide well regulated supply for low voltage IC applications requiring 3.3V output. The IRU1030-33 is guaranteed to have <1.3V dropout at full load current making it ideal to provide well regulated output with supply voltage as low as 4.6V input.

**TYPICAL APPLICATION**

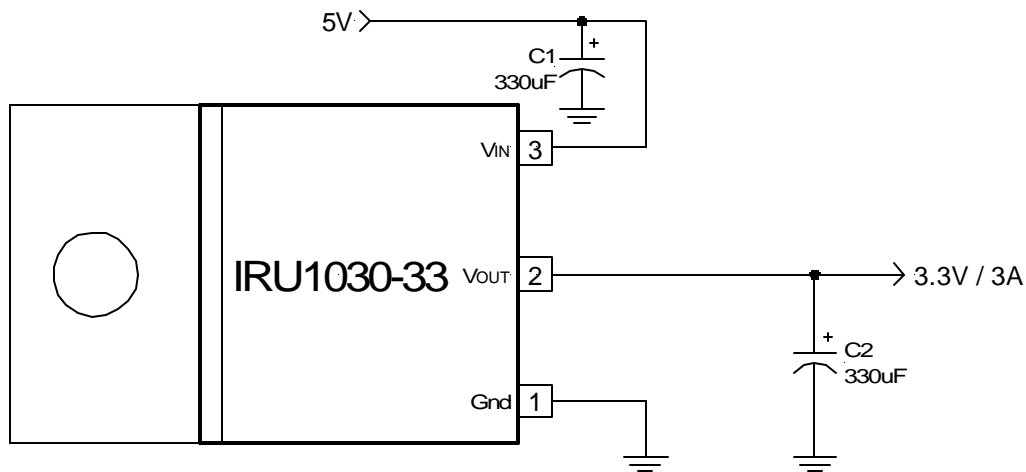

Figure 1 - Typical application of IRU1030-33.

**TYPICAL APPLICATION**

T <sub>J</sub> (°C)	3-PIN PLASTIC TO-220 (T)	3-PIN PLASTIC TO-263 (M)	2-PIN PLASTIC Ultra Thin-Pak™ (P)	2-PIN PLASTIC TO-252 (D-Pak)
0 To 150	IRU1030-33CT	IRU1030-33CM	IRU1030-33CP	IRU1030-33CD

**ABSOLUTE MAXIMUM RATINGS**

Input Voltage ( $V_{IN}$ ) .....	7V
Power Dissipation .....	Internally Limited
Storage Temperature Range .....	-65°C To 150°C
Operating Junction Temperature Range .....	0°C To 150°C

**PACKAGE INFORMATION**

3-PIN PLASTIC TO-220 (T)	3-PIN PLASTIC TO-263 (M)	2-PIN PLASTIC ULTRA THIN-PAK™ (P)	2-PIN PLASTIC TO-252 (D-Pak)
<p><math>\theta_{JT}=2.7^{\circ}\text{C/W}</math> <math>\theta_{JA}=60^{\circ}\text{C/W}</math></p>	<p><math>\theta_{JA}=35^{\circ}\text{C/W}</math> for 1" Square pad</p>	<p><math>\theta_{JA}=70^{\circ}\text{C/W}</math> for 1" Square pad</p>	<p><math>\theta_{JA}=70^{\circ}\text{C/W}</math> for 0.5" Sq pad</p>

**ELECTRICAL SPECIFICATIONS**

Unless otherwise specified, these specifications apply over  $C_{IN}=1\mu\text{F}$ ,  $C_{OUT}=10\mu\text{F}$ , and  $T_J=0$  to  $150^{\circ}\text{C}$ . Typical values refer to  $T_J=25^{\circ}\text{C}$ .

PARAMETER	SYM	TEST CONDITION	MIN	TYP	MAX	UNITS
Output Voltage	$V_O$	$I_O=10\text{mA}$ , $T_J=25^{\circ}\text{C}$ , $V_{IN}=5\text{V}$ $I_O=10\text{mA}$ , $V_{IN}=5\text{V}$	3.267 3.234	3.300 3.300	3.333 3.366	V
Line Regulation		$I_O=10\text{mA}$ , $4.7\text{V}<V_{IN}<7\text{V}$			0.2	%
Load Regulation (Note 1)		$V_{IN}=5\text{V}$ , $V_{ADJ}=0$ , $10\text{mA}<I_O<3\text{A}$			0.4	%
Dropout Voltage (Note 2)	$\Delta V_O$	Note 2, $I_O=3\text{A}$		1.1	1.3	V
Current Limit		$V_{IN}=5\text{V}$ , $\Delta V_O=100\text{mV}$	3.1			A
Minimum Load Current (Note 3)		$V_{IN}=5\text{V}$		5	10	mA
Thermal Regulation		30ms Pulse, $V_{IN}-V_O=3\text{V}$ , $I_O=3\text{A}$		0.01	0.02	%/W
Ripple Rejection		$f=120\text{Hz}$ , $C_O=25\mu\text{F}$ Tantalum, $I_O=1.5\text{A}$ , $V_{IN}-V_O=3\text{V}$	60	70		dB
Adjust Pin Current Change		$I_O=10\text{mA}$ , $V_{IN}-V_O=1.5\text{V}$ , $T_J=25^{\circ}\text{C}$		0.2	5	$\mu\text{A}$
Temperature Stability		$V_{IN}=5\text{V}$ , $V_{ADJ}=0\text{V}$ , $I_O=10\text{mA}$		0.5		%
Long Term Stability		$T_J=125^{\circ}\text{C}$ , 1000Hrs		0.3	1	%
RMS Output Noise		$T_J=25^{\circ}\text{C}$ , $10\text{Hz}<f<10\text{KHz}$		0.003		% $V_O$

**Note 1:** Low duty cycle pulse testing with Kelvin connections is required in order to maintain accurate data.

**Note 2:** Dropout voltage is defined as the minimum differential voltage between  $V_{IN}$  and  $V_{OUT}$  required to maintain regulation at  $V_{OUT}$ . It is measured when the output voltage drops 1% below its nominal value.

**Note 3:** Minimum load current is defined as the minimum current required at the output in order for the output voltage to maintain regulation. Typically the resistor dividers are selected such that it automatically maintains this current.

**PIN DESCRIPTIONS**

PIN #	PIN SYMBOL	PIN DESCRIPTION
1	Gnd	This pin must be connected to ground plane using a low inductance short connection.
2	V <sub>OUT</sub>	The output of the regulator. A minimum of 10μF capacitor must be connected from this pin to ground to insure stability.
3	V <sub>IN</sub>	The input pin of the regulator. Typically a large storage capacitor is connected from this pin to ground to insure that the input voltage does not sag below the minimum drop out voltage during the load transient response. This pin must always be 1.3V higher than V <sub>OUT</sub> in order for the device to regulate properly.

**BLOCK DIAGRAM**

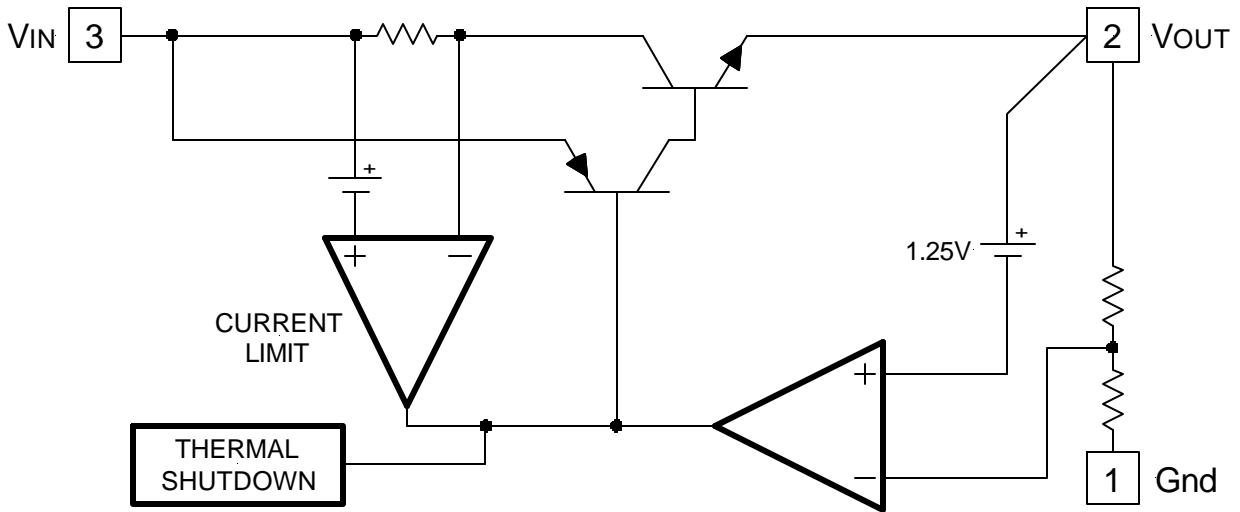

Figure 2 - Simplified block diagram of the IRU1030-33.

**APPLICATION INFORMATION**

**Stability**

The IRU1030-33 requires the use of an output capacitor as part of the frequency compensation in order to make the regulator stable. Typical designs for microprocessor applications use standard electrolytic capacitors with a typical ESR in the range of 50 to 100mΩ and an output capacitance of 500 to 1000μF. Fortunately as the capacitance increases, the ESR decreases resulting in a fixed RC time constant. The IRU1030-33 takes advantage of this phenomena in making the overall regulator loop stable. For most applications a minimum of 100μF aluminum electrolytic capacitor such as Sanyo MVGX series, Panasonic FA series as well as the Nichicon PL series insures both stability and good transient response.

**(D) TO-252 Package  
 2-Pin**



SYMBOL	MIN	MAX
A	6.477	6.731
B	5.004	5.207
C	0.686	0.838
D	7.417	8.179
E	9.703	10.084
F	0.635	0.889
G	2.286 BSC	
H	4.521	4.623
J	Ø1.52	Ø1.62
K	2.184	2.388
L	0.762	0.864
M	1.016	1.118
N	5.969	6.223
O	1.016	1.118
P	0	0.102
Q	0.534	0.686
R	R0.31 TYP	
R1	R0.51 TYP	
S	0.428	0.588

NOTE: ALL MEASUREMENTS  
 ARE IN MILLIMETERS.

**(M) TO-263 Package  
 3-Pin**

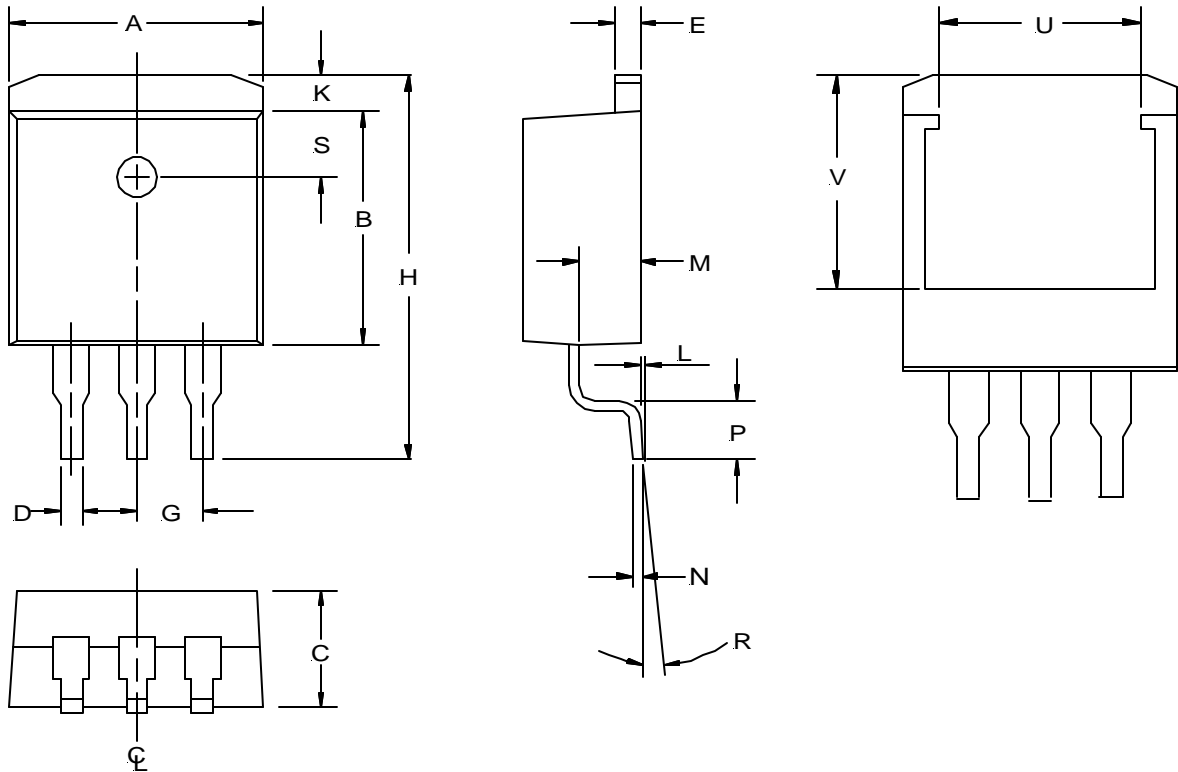

SYMBOL	MIN	MAX
A	10.05	10.312
B	8.28	8.763
C	4.31	4.572
D	0.66	0.91
E	1.14	1.40
G	2.54 REF	
H	14.73	15.75
K	1.40	1.68
L	0.00	0.254
M	2.49	2.74
N	0.33	0.58
P	2.286	2.794
R	0°	8°
S	2.41	2.67
U	6.50 REF	
V	7.75 REF	

NOTE: ALL MEASUREMENTS  
 ARE IN MILLIMETERS.

**(P) Ultra Thin-Pak™  
 2-Pin**

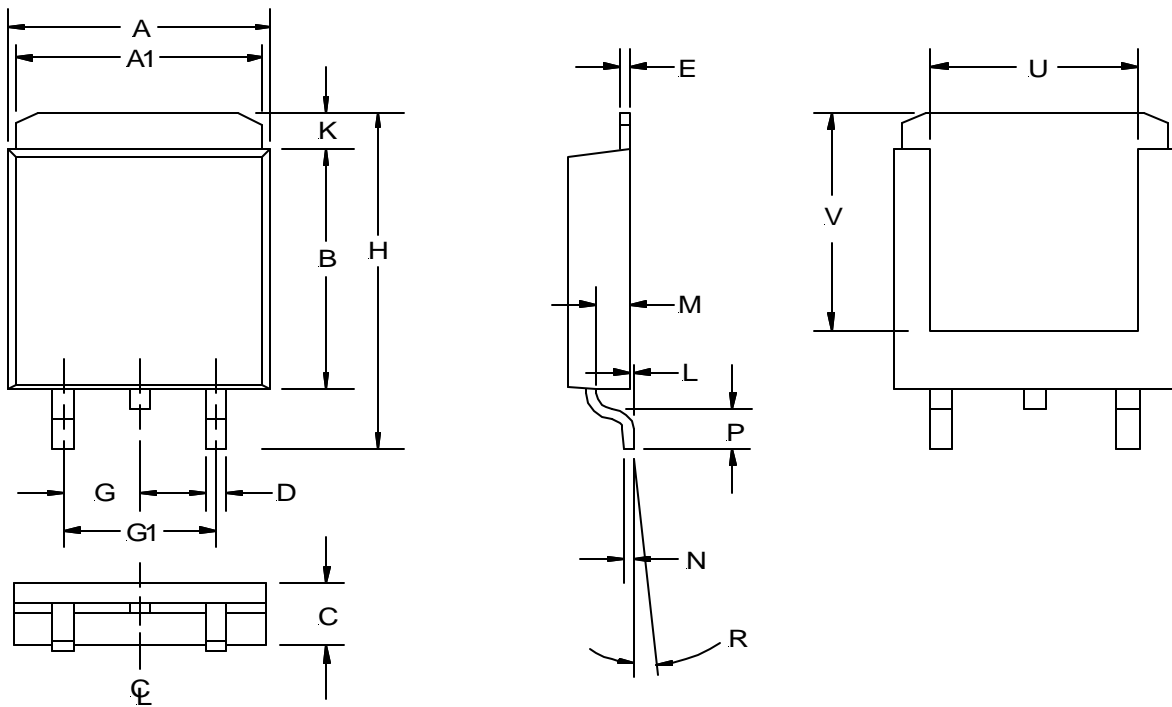

SYMBOL	MIN	MAX
A	5.91	6.17
A1	5.54	5.79
B	6.02	6.27
C	1.70	2.03
D	0.63	0.79
E	0.17	0.33
G	2.16	2.41
G1	4.45	4.70
H	9.42	9.68
K	0.76	1.27
L	0.02	0.13
M	0.89	1.14
N	0.25	0.25
P	0.94	1.19
R	2°	6°
U	2.92	3.30
V	5.08 NOM	

NOTE: ALL MEASUREMENTS  
 ARE IN MILLIMETERS.

**(T) TO-220 Package  
 3-Pin**

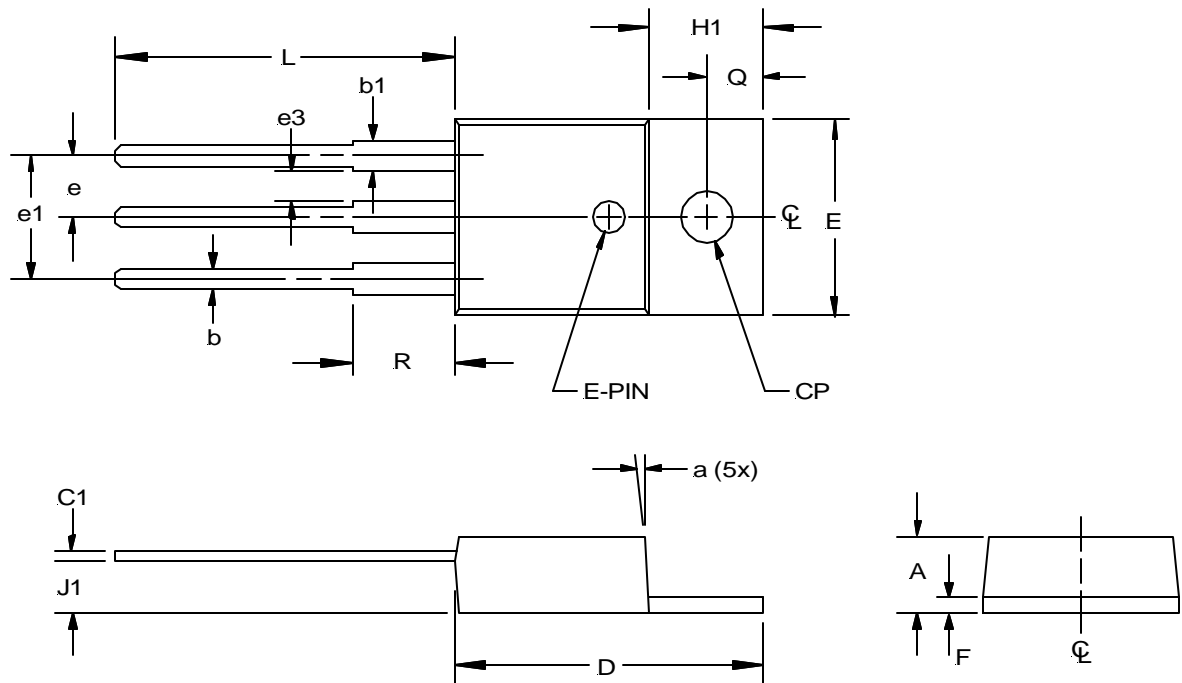

SYMBOL	MIN	MAX
A	4.06	4.83
a	3°	7.5°
b	0.63	1.02
b1	1.14	1.52
C1	0.38	0.56
CP	3.71D	3.96D
D	14.22	15.062
E	9.78	10.54
e	2.29	2.79
e1	4.83	5.33
e3	1.14	1.40
F	1.14	1.40
H1	5.94	6.55
J1	2.29	2.92
L	13.716	14.22
Q	2.62	2.87
R	5.588	6.17

NOTE: ALL MEASUREMENTS  
 ARE IN MILLIMETERS.

**PACKAGE SHIPMENT METHOD**

PKG DESIG	PACKAGE DESCRIPTION	PIN COUNT	PARTS PER TUBE	PARTS PER REEL	T & R Orientation
D	TO-252, (D-Pak)	2	75	2500	Fig A
M	TO-263	3	50	750	Fig B
P	Ultra Thin-Pak™	2	75	2500	Fig C
T	TO-220	3	50	---	---

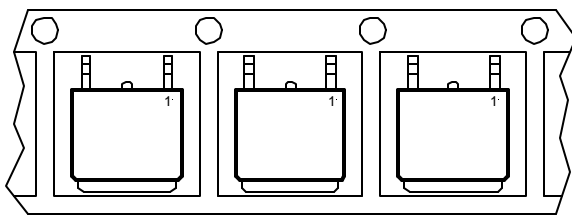

Feed Direction  
Figure A

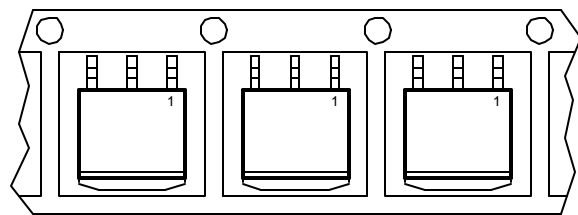

Feed Direction  
Figure B

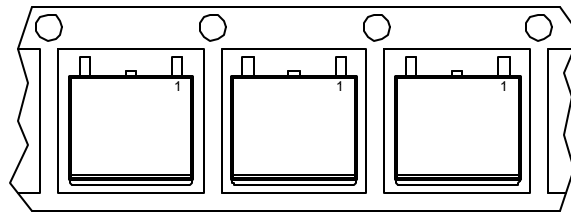

Feed Direction  
Figure C