

PLEASE CHECK WWW.MOLEX.COM FOR LATEST PART INFORMATION

Part Number: [0875691012](#)
Status: **Active**
Overview: milligrd
Description: 2.00mm (.079") Strain Relief for Dual Row IDT, 12 circuits

Documents:

[3D Model](#) [Product Specification PS-87568-004 \(PDF\)](#)
[Drawing \(PDF\)](#) [RoHS Certificate of Compliance \(PDF\)](#)

General

Product Family	Accessories
Series	87569
Component Type	Strain Relief
Overview	milligrd
Product Literature Order No	987650-1991
Product Name	Milli-Grid™

Physical

Circuits (Loaded)	12
Color - Resin	Black
Gender	N/A
Material - Resin	High Temperature Thermoplastic
Number of Rows	2
Packaging Type	Bag

Material Info

Reference - Drawing Numbers

Product Specification	PS-87568-004
Sales Drawing	SD-87569-008

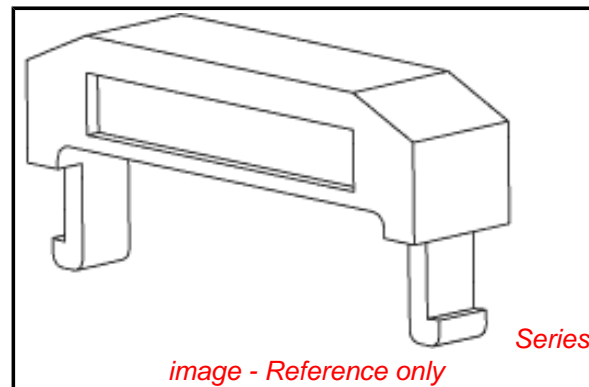

EU RoHS

**ELV and RoHS
Compliant**
**REACH SVHC
Contains SVHC: No**
**Halogen-Free
Status**

China RoHS



Not Reviewed

**Need more information on product
environmental compliance?**

Email productcompliance@molex.com
 For a multiple part number RoHS Certificate of
 Compliance, [click here](#)

Please visit the [Contact Us](#) section for any
 non-product compliance questions.

Search Parts in this Series

[87569Series](#)

Use With

PCB Receptacle

ENGINEERING NUMBER	CKT. SIZE	A	B	C
87569-1010	10	15.40	12.20	14.25
87569-1012	12	17.40	14.20	16.25
87569-1014	14	19.40	16.20	18.25
87569-1016	16	21.40	18.20	20.25
87569-1020	20	25.40	22.20	24.25
87569-1022	22	27.40	24.20	26.25
87569-1024	24	29.40	26.20	28.25
87569-1026	26	31.40	28.20	30.25
87569-1030	30	35.40	32.20	34.25
87569-1032	32	37.40	34.20	36.25
87569-1034	34	39.40	36.20	38.25
87569-1040	40	45.40	42.20	44.25
87569-1044	44	49.40	46.20	48.25
87569-1050	50	55.40	52.20	54.25

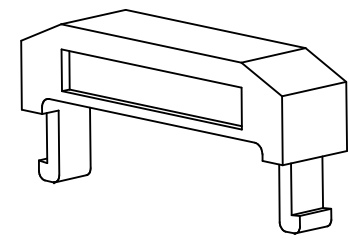
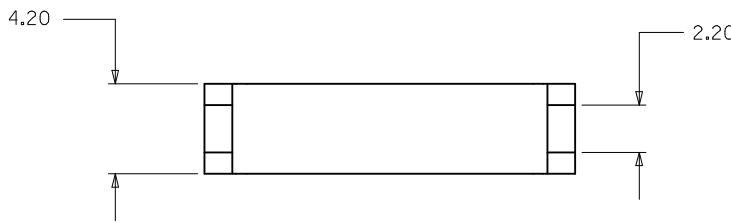
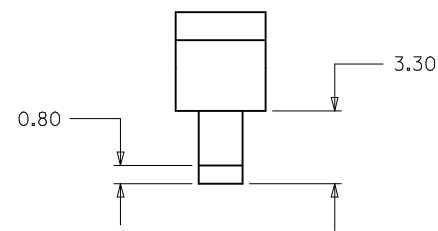
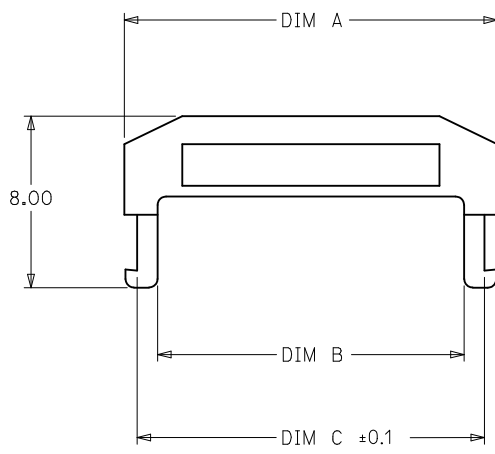

87569 - 1 0 * *
 ↳ CKT. SIZE

NOTES

1. MATERIAL : THERMOPLASTIC, UL94V-0 BLACK
2. FOR ILLUSTRATION PURPOSES A 12 CIRCUIT SIZE PART IS SHOWN.
3. FOR ALL OTHER CIRCUIT SIZES CONTACT FACTORY.

ADD 32CKT OPTION EC NO: S2010-0273 DRWN:SKANG CHKD:ATSEE APPR:MLONG	2009/09/28 2009/11/13 2009/11/17	DESCRIPTION REV	QUALITY SYMBOLS	GENERAL TOLERANCES (UNLESS SPECIFIED)		DIMENSION STYLE MM ONLY		SCALE NTS	DESIGN UNITS METRIC	THIRD ANGLE PROJECTION		
			$\nabla_A = 0$ $\nabla_C = 0$ $\nabla_F = 0$	4 PLACES	mm	INCH	DRAWN BY MSAKTHI	DATE 1999/02/25	TITLE MGRID, 2MM DUAL ROW IDT			
				3 PLACES	± ---	± ---	CHECKED BY JSGOH	DATE 1999/07/19				
				2 PLACES	± 0.2	± ---	APPROVED BY MLONG	DATE 2009/11/13	MATERIAL NO. SEE TABLE		DOCUMENT NO. SD-87569-008	SHEET NO. 1 OF 1
DRAFT WHERE APPLICABLE MUST REMAIN WITHIN DIMENSIONS				ANGULAR ± 3 °		THIS DRAWING CONTAINS INFORMATION THAT IS PROPRIETARY TO MOLEX INCORPORATED AND SHOULD NOT BE USED WITHOUT WRITTEN PERMISSION						