

PLEASE CHECK WWW.MOLEX.COM FOR LATEST PART INFORMATION

Part Number: [0351503609](#)
Status: **Active**
Overview: [versablade](#)
Description: 7.30mm (.287") Pitch Wire-to-Wire VersaBlade™ Hybrid Receptacle Housing, without Mounting Ears, 6 Circuits, Polyester Carbonate UL94V-0, Yellow, Glow Wire Compatible

Documents:

[3D Model](#) [RoHS Certificate of Compliance \(PDF\)](#)
[Drawing \(PDF\)](#)

Agency Certification

CSA	LR19980
TUV	R72090206
UL	E29179

General

Product Family	Crimp Housings
Series	35150
Comments	Polarized to Mating Part, Positive Lock
Overview	versablade
Product Name	VersaBlade™

Physical

Breakaway	No
Circuits (maximum)	6
Color - Resin	Yellow
Flammability	94V-0
Gender	Male
Glow-Wire Compliant	Yes
Keying to Mating Part	None
Lock to Mating Part	Yes
Material - Resin	Polyester Alloy
Number of Rows	2
Packaging Type	Bag
Panel Mount	No
Pitch - Mating Interface (in)	0.287 In
Pitch - Mating Interface (mm)	7.30 mm
Pitch - Term. Interface (in)	0.287 In
Pitch - Term. Interface (mm)	7.30 mm
Polarized to Mating Part	Yes
Ports	1
Stackable	No
Temperature Range - Operating	-40°C to +120°C

Material Info

Reference - Drawing Numbers

Sales Drawing	SD-35150-060
---------------	--------------

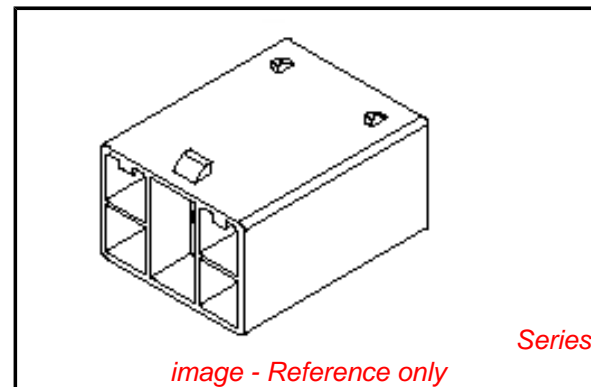

EU RoHS

ELV and RoHS Compliant
REACH SVHC
 Not Reviewed
Halogen-Free Status
Not Reviewed

China RoHS



Need more information on product environmental compliance?

Email productcompliance@molex.com
 For a multiple part number RoHS Certificate of Compliance, [click here](#)

Please visit the [Contact Us](#) section for any non-product compliance questions.

Search Parts in this Series

[35150Series](#)

Mates With

[35151061*](#) Plug Housings

Use With

VersaBlade™ Crimp Terminals, [35745](#) , [35746](#) , [35747](#)

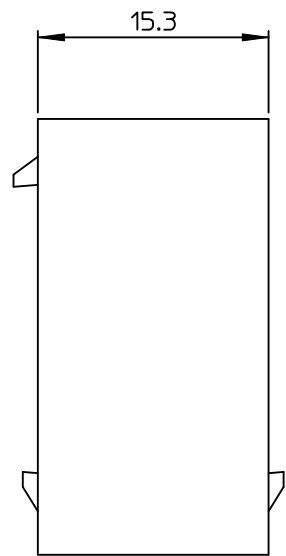
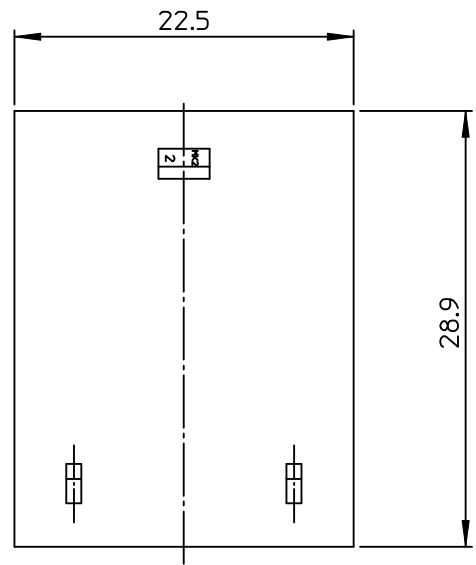
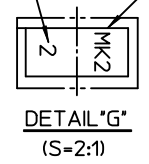
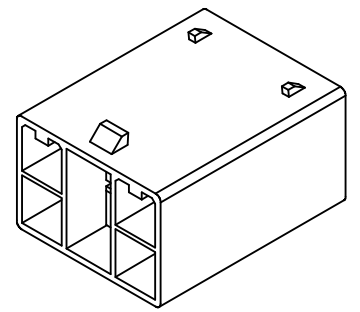
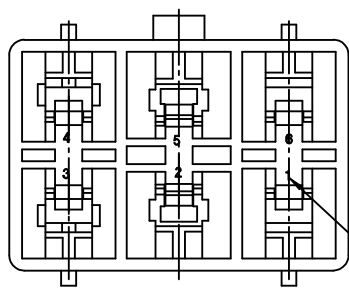
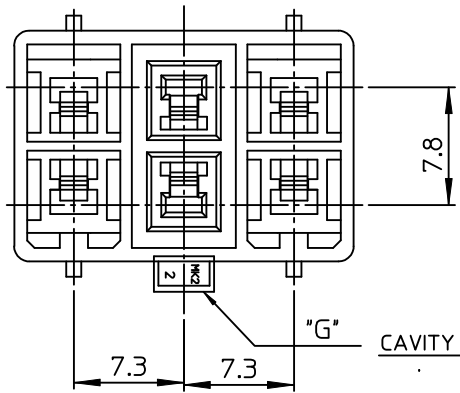

MATERIAL	MATERIAL NO.	ENG NO.	COLOR
POLYESTER(P.B.T) (UL94V-0)	351500600	35150-0600	NATURAL
	351500604	35150-0604	BLUE
PC/PET (UL94V-0)	351500609	35150-0609	NATURAL
	351503609	35150-3609	YELLOW

- NOTES
- MATED HOUSING : 35151-061*
35150-039* (TPA)
 - APPLICABLE TERMINAL : 35745-0*10 (3,4 CIRCUIT)
35746-0*10 (2,5 CIRCUIT)
35747-0*10 (1,6 CIRCUIT)



REVISED EC NO: KOR2009-0026 DRAWN: JHPARK01 2008/09/25 CHKD: WY. YANG 2008/11/25 APPR: YUNSIKKIM 2008/11/25	QUALITY SYMBOLS ▽=0 ▽=0	GENERAL TOLERANCES (UNLESS SPECIFIED)		DIMENSION STYLE MM ONLY		SCALE 2:1	DESIGN UNITS METRIC	THIRD ANGLE PROJECTION		
		4 PLACES	± ---	± ---	DRAWN BY	DATE	TITLE 7.3 PITCH W/W CONN. MALE HSG-6P(W/O EAR)			
		3 PLACES	± ---	± ---	BK. CHOI	1993/05/19				
		2 PLACES	± 0.3	± ---	CHECKED BY	DATE	MOLEX INCORPORATED			
1 PLACE	± 0.3	± ---	BK. CHOI	1993/05/19						
		ANGULAR ± 1 °		APPROVED BY	DATE	MATERIAL NO.		DOCUMENT NO.		
		DRAFT WHERE APPLICABLE MUST REMAIN WITHIN DIMENSIONS		CW. LEE 1993/05/19		SEE TABLE		SD-35150-060		
				SIZE A3		THIS DRAWING CONTAINS INFORMATION THAT IS PROPRIETARY TO MOLEX INCORPORATED AND SHOULD NOT BE USED WITHOUT WRITTEN PERMISSION		SHEET NO. 1 OF 01		