

BTR-7920G / BTR-7920-SPG / BTR-7920AG / BTR-7920A-SPG

1490 nm TX / 1310 nm RX , 3.3V / 1.25 Gb/s **RoHS Compliant Single-Fiber Transceiver**

FEATURES

- | Bi-Directional Single-Fiber Transceiver
- | Compliant with IEEE 802.3ah 1000BASE-BX
- | 1490 nm DFB LD Transmitter
- | 1310 nm Receiver
- | 14 dB Power Budget At Least
- | Link distance up to 20 km
- | Industry Standard 1 x 9 Footprint
- | Single +3.3 V Power Supply
- | RoHS Compliant
- | 0 to 70°C Operating: BTR-7920G
- | -20 to 85°C Operating: BTR-7920AG
- | LVPECL Differential Inputs and Outputs
- | LVPECL Signal Detect Output: BTR-7920G
- | LVTTTL Signal Detect Output: BTR-7920CG
- | Wave Solderable and Aqueous Washable
- | Class 1 Laser International Safety Standard IEC- 60825 Compliant

APPLICATIONS

- | WDM 1.25 Gb/s Links
- | SONET/SDH Equipment Interconnect
- | Fiber Channel 1.063 Gb/s Links

DESCRIPTION

The BTR-7920G series is high performance module for single fiber communications by using 1490 nm transmitter and 1310 nm receiver. The transmitter section uses a multiple quantum well laser and is a class 1 laser compliant according to International Safety Standard IEC-60825. The receiver section is designed to receive 1310 nm and block 1490 nm signal. This feature is suitable for IEEE 802.3ah 1000BASE-BX and ITU-T 983.3 application. The receiver section uses an integrated 1310 nm detector preamplifier (IDP) mounted in an optical header and a limiting post-amplifier IC. A PECL logic interface simplifies interface to external circuitry.

LASER SAFETY

This single mode transceiver is a Class 1 laser product. It complies with IEC-60825 and FDA 21 CFR 1040.10 and 1040.11. The transceiver must be operated within the specified temperature and voltage limits. The optical ports of the module shall be terminated with an optical connector or with a dust plug.

ORDER INFORMATION

P/No.	1000 BASE	Bit Rate (Gb/s)	Distance (km)	TX (nm)	RX (nm)	Voltage (V)	Package	Temp (°C)	TX Power (dBm)	RX Sens. (dBm)	RoHS Compliant
BTR-7920G	BX	1.25	20	1490 DFB	1310	3.3	1X9	0 to 70	-3 to -8	-22	Yes
BTR-7920AG	BX	1.25	20	1490 DFB	1310	3.3	1X9	-20 to 85	-3 to -8	-22	Yes

- Note: 1. BTR-XXXX is 1X9 SC receptacle type package.
 2. BTR-XXXX-APBBB is 1X9 pigtail type package with different connector, A=S is SC connector, A=F is FC connector, A=T is ST connector, A=L is LC connector, A=M is MU connector; BBB is the length of fiber in cm.

Absolute Maximum Ratings					
Parameter	Symbol	Min	Max	Units	Notes
Storage Temperature	Tstg	-40	85	°C	
Operating Temperature	Topr	0 -20	70 85	°C	BTR-7920G BTR-7920AG/air flow 1m/sec
Soldering Temperature	---		260	°C	10 seconds on leads only
Power Supply Voltage	Vcc	0	3.6	V	
Input Voltage	---	GND	Vcc	V	
Output Current	Iout	0	30	mA	

Recommended Operating Conditions					
Parameter	Symbol	Min	Typ	Max	Units / Notes
Power Supply Voltage	Vcc	3.13	3.3	3.47	V
Operating Temperature	Topr	0 -20		70 85	°C / BTR-7920G °C / BTR-7920AG
Data Rate			1250	1300	Mb/s
Power Supply Current	Icc			280	mA

Transmitter Specifications (0°C < Topr < 70°C, 3.13V < Vcc < 3.47V)						
Parameter	Symbol	Min	Typ	Max	Units	Notes
Optical						
Optical Transmit Power	Po	-8	---	-3	dBm	1
Output Center Wavelength	λ	1480		1500	nm	
Output Spectrum Width	$\Delta\lambda$	---	---	1	nm	-20 dB Width
Extinction Ratio	ER	9.0	---	---	dB	
Output Eye	Compliant with IEEE 802.3z					
Optical Rise Time	t _r			0.26	ns	20% to 80% Values
Optical Fall Time	t _f			0.26	ns	20% to 80% Values
Relative Intensity Noise	RIN			-120	dB/Hz	
Total Jitter	TJ			0.227	ns	2
Electrical						
Data Input Current – Low	I _{IL}	-350			μA	
Data Input Current – High	I _{IH}			350	μA	
Differential Input Voltage	V _{IH} - V _{IL}	300			mV	
Data Input Voltage – Low	V _{IL} - V _{CC}	-2.0		-1.58	V	3
Data Input Voltage -- High	V _{IH} - V _{CC}	-1.1		-0.74	V	3

- Notes: 1. Output power is power coupled into a 9/125 μm single mode fiber.
 2. Measured with a 2⁷-1 PRBS.
 3. These inputs are compatible with 10K, 10KH and 100K ECL and LVPECL inputs.

Receiver Specifications (0°C < Topr < 70°C, 3.13 V < Vcc < 3.47V)						
Parameter	Symbol	Min	Typ	Max	Units	Notes
Optical						
Sensitivity	---	---	---	-22	dBm	1
Maximum Input Power	Pin	-3	---	---	dBm	
Signal Detect -- Asserted	Pa	---	---	-22	dBm	Transition: low to high
Signal Detect -- Deasserted	Pd	-31	---	---	dBm	Transition: high to low
Signal detect -- Hysteresis		1.0	---		dB	
Wavelength of Operation		1260		1360	nm	2
Optical Return Loss	ORL	14			dB	
Electrical						
Data Output Voltage – Low	V _{OL} - V _{CC}	-2.0		-1.58	V	3
Data Output Voltage – High	V _{OH} - V _{CC}	-1.1		-0.74	V	3
SD Output Voltage -- Low	V _{OL} - V _{CC}	-2.0		-1.58	V	BTR-7920G
SD Output Voltage -- High	V _{OH} - V _{CC}	-1.1		-0.74	V	
SD Output Voltage -- Low	V _{OL}	0		0.8	V	BTR-7920CG
SD Output Voltage -- High	V _{OH}	2.0		V _{cc} +0.3	V	

Notes: 1. Minimum sensitivity and saturation levels at BER 1E-12 for a 2⁷-1 PRBS.
 2. At least 30 dB optical isolation for the wavelength 1480 to 1580 nm.
 3. These outputs are compatible with 10K, 10KH and 100K ECL and LVPECL outputs.

CONNECTION DIAGRAM

Receiver Signal Ground	1 (Rx GND)	○
Receiver Data Out	2 (RD+)	N/C
Receiver Data Out Bar	3 (RD-)	
Signal Detect	4 (SD)	
Receiver Power Supply	5 (Rx Vcc)	TOP VIEW
Transmitter Power Supply	6 (Tx Vcc)	
Transmitter Data In Bar	7 (TD-)	
Transmitter Data In	8 (TD+)	N/C
Transmitter Signal Ground	9 (Tx GND)	○

PIN	Symbol	Notes
1	Rx GND	Directly connect this pin to the receiver ground plane
2	RD+	See recommended circuit schematic
3	RD-	See recommended circuit schematic
4	SD	Active high on this indicates a received optical signal
5	Rx Vcc	+3.3V dc power for the receiver section
6	Tx Vcc	+3.3V dc power for the transmitter section
7	TD-	See recommended circuit schematic
8	TD+	See recommended circuit schematic
9	Tx GND	Directly connect this plan to the transmitter ground plane

RECOMMENDED CIRCUIT SCHEMATIC

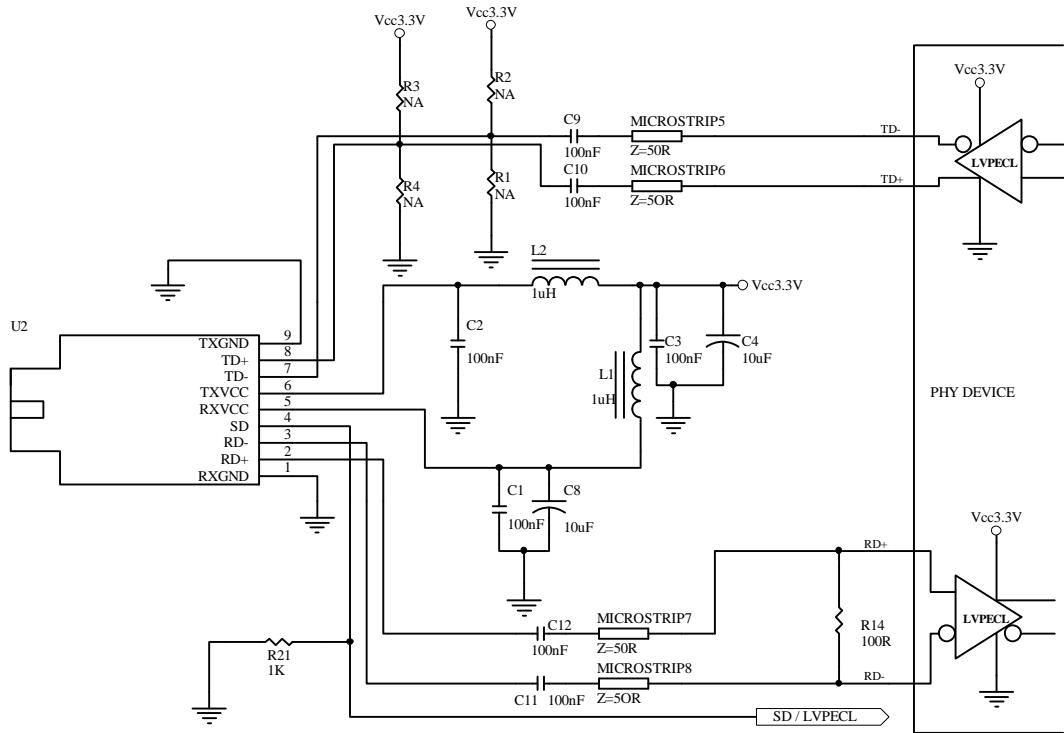

The split-load terminations for ECL signals need to be located at the input of devices receiving those ECL signals. The power supply filtering is required for good EMI performance. Use short tracks from the inductor L1/L2 to the module Rx Vcc and Tx Vcc. A GND plane under the module is required for good EMI and sensitivity performance.

PACKAGE DIAGRAM

Units in mm

1) Pigtail Type

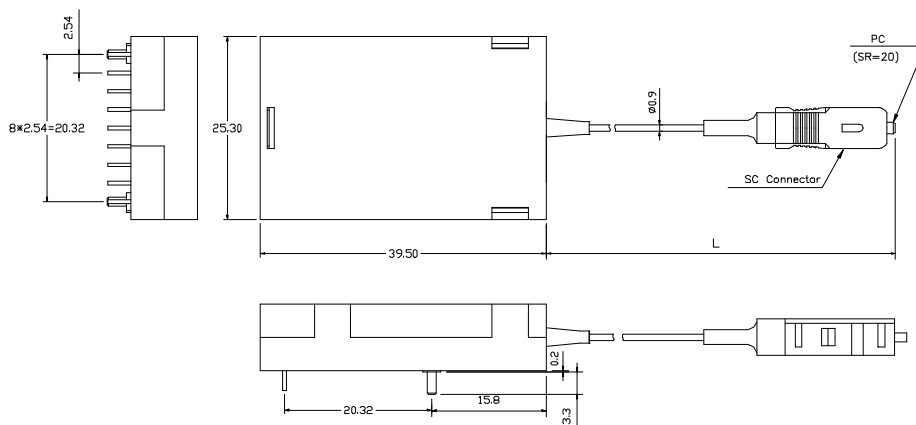

BTR-7920-SP50G / BTR-7920C-SP50G

Note: Length L is 50 ± 3 cm. Other pigtail's length is available upon request.

2) Receptacle Type

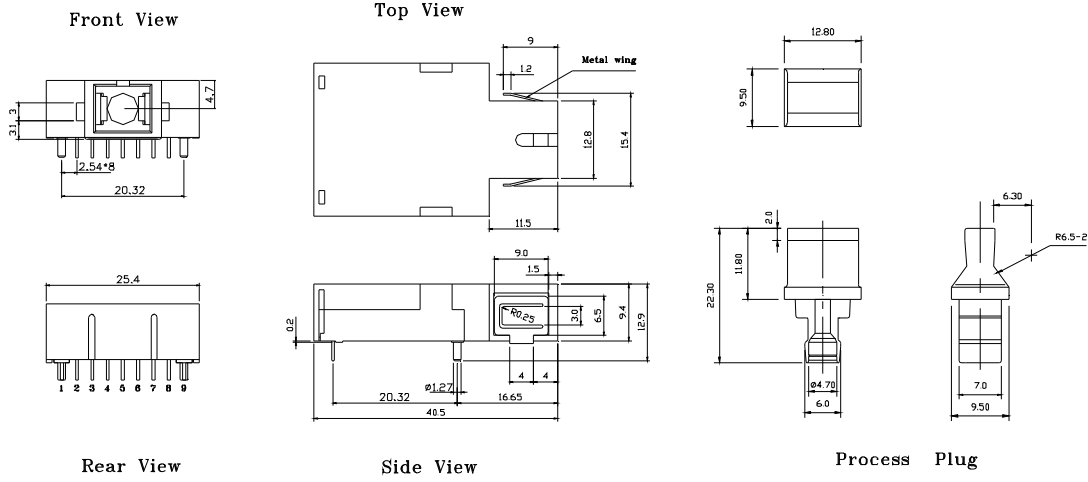

BTR-7920G / BTR-7920CG

Note: Specifications subject to change without notice.