

Spec. No.	RSK-116	P.:1/4
Date	Sep 12,2001	
Version	First	

液晶之友 电话: 020-33819057
[Http://www.lcdfriends.com](http://www.lcdfriends.com)

PRELIMINARY SPECIFICATION

Product name : 2-Electrode GDT

Type : R28-351-BHL



OKAYA ELECTRIC INDUSTRIES CO., LTD.

Spec. No.	RSK-116
Date	Sep 12,2001
Version	First

1. Scope This specification covers 2-Electrode GDT (Gas Discharge Tube) R28-351-BHL.

2. Type designation

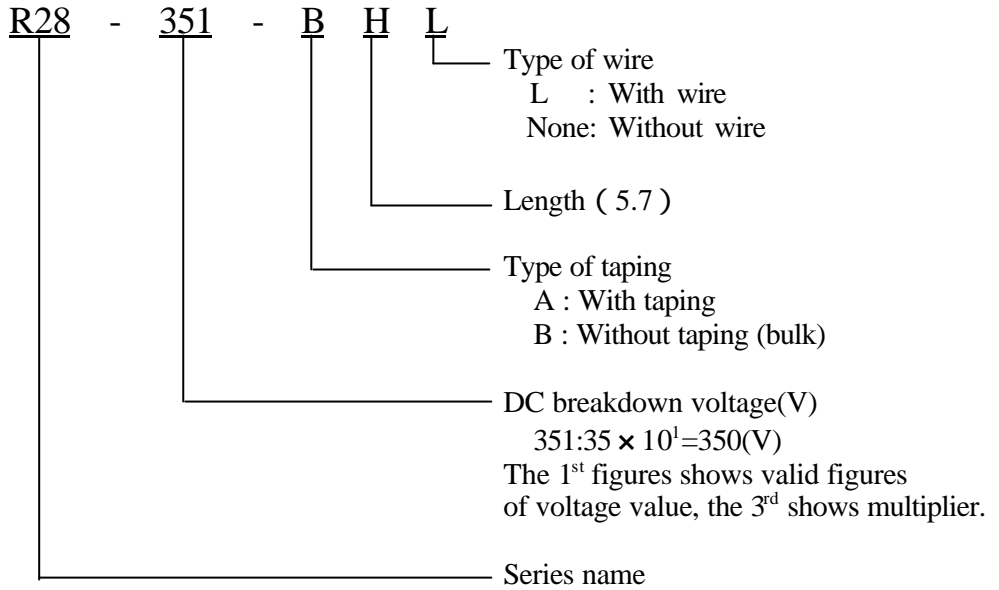

3. Appearance · Structure

- 3-1 Appearance Scratches, rust, dirt that affect the use of the product in a damaging way are not allowed
- 3-2 Dimension Refer to drawing 4R-4219-Y05
- 3-3 Display and contents Not easily to disappear, to be visible

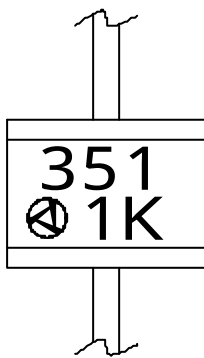
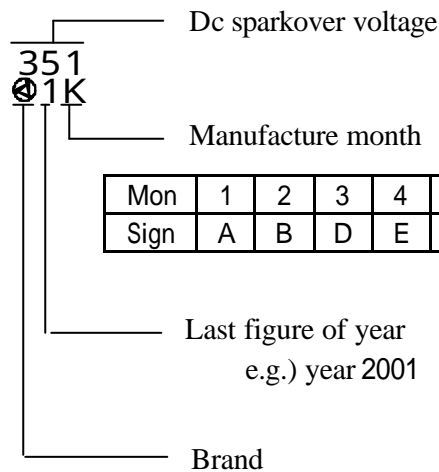

Fig.1 Example of marking



Mon	1	2	3	4	5	6	7	8	9	10	11	12
Sign	A	B	D	E	F	G	H	J	K	L	M	N

- 3-4 Materials Ceramic, alloy of iron and nickle, cp wire, etc.
No radioactive substance is used in this product.



Spec. No.	RSK-116	P:3/4
Date	Sep 12,2001	
Version	First	

4 . Electrical characteristics

No.	Item	Test condition	Spec.			Units	
			Min.	Typ.	Max.		
1	DC sparkover voltage	100V/s to 500V/s	280	350	420	V	
2	Impulse sparkover voltage	100V/ μ s	-	-	600	V	
3	Insulation resistance	DC100V	10^{10}	-	-	Ω	
4	Capacitance	1MHz	-	-	2.0	pF	
5	Impulse life test	10/1000 μ s 200A 1000 times interval 60s	DC sparkover voltage	245	350	455	V
			Impulse sparkover voltage	-	-	900	V
			Insulation resistance	10^8	-	-	Ω
6	Alternating discharge current	7Arms-1s \times 10times @50Hz interval 30s	DC sparkover voltage	260	350	525	V
			Impulse sparkover voltage	-	-	900	V
			Insulation resistance	10^8	-	-	Ω
7	Impulse discharge current	8/20 μ s 7.5kA 10 times interval 60s	DC sparkover voltage	260	350	525	V
			Impulse sparkover voltage	-	-	900	V
			Insulation resistance	10^8	-	-	Ω

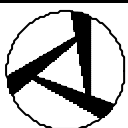

OKAYA ELECTRIC INDUSTRIES CO., LTD.

Spec. No.	RSK-117
Date	Sep 12, 2001
Version	First

5 . Operating condition

Operating temperature -40 to +90
 Storage temperature -20 to +100

6 . Packing

Put 50pcs of R28 series and 1pc of product label in a vinyl bag of specified size, seal the bag with a stapler, put bags of quantity required into a box, pack and attach product label on the box.

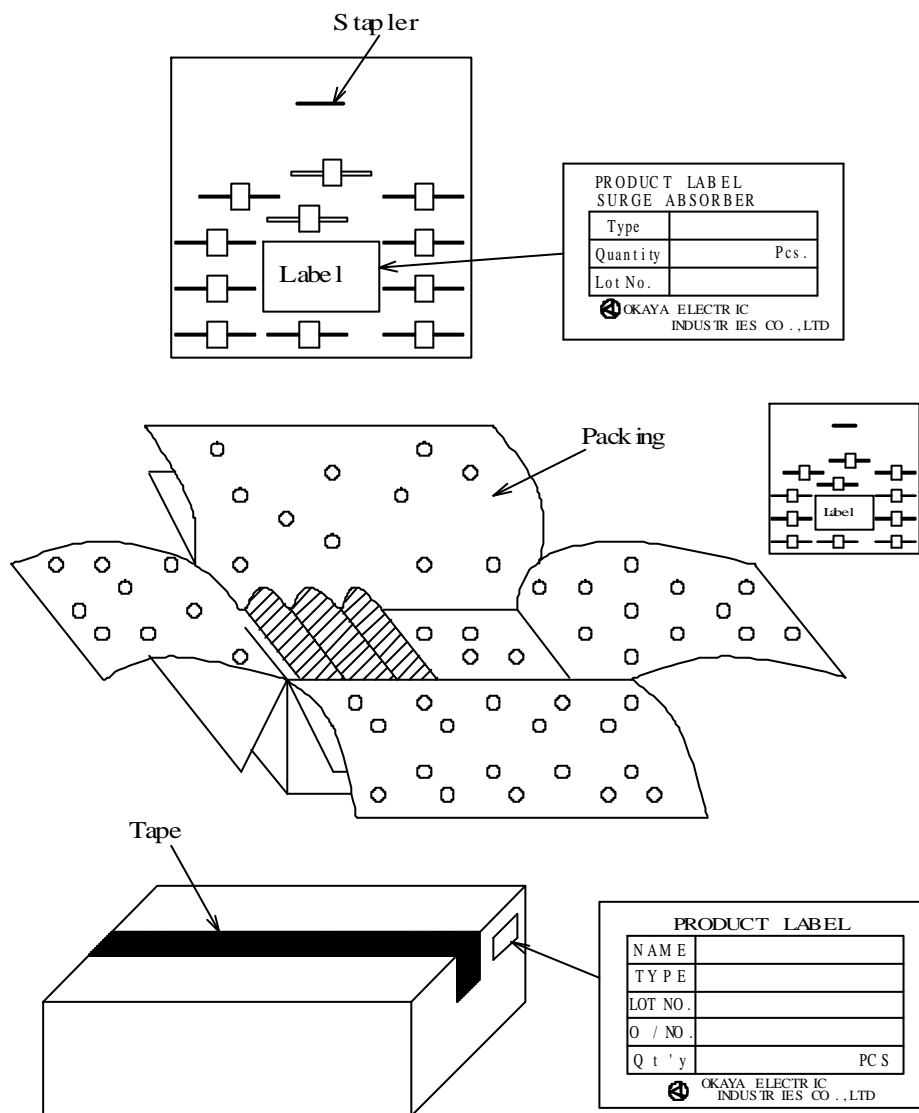

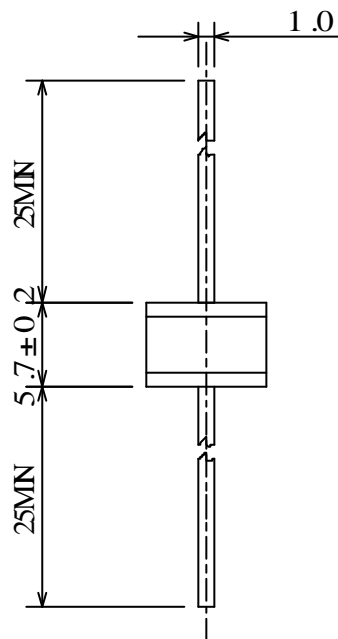
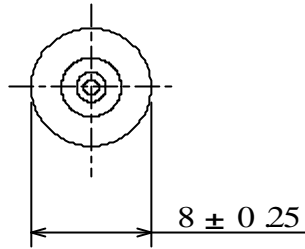

Weight : approx . 2g

Ver.	Rev. data	History of rev.	Date	Scale	Product name	
			Sep 12 , 2001	2:1	2- Electrode GD T	
					Type name	
					Outline dimension (8.0×5.7)	
					Drawing No.	
OKAYA ELECTRIC INDUSTRIES CO . , LTD					4R-4219-Y05	4