

Power Management Switch ICs for PCs and Digital Consumer Products

2ch High Side Switch ICs for USB Devices and Memory Cards



BD6512F, BD6513F, BD6516F, BD6517F, BD2042AFJ, BD2052AFJ

No.11029EBT11

●Description

High side switch for USB is a high side switch having over current protection used in power supply line of universal serial bus (USB). Its switch unit has two channels of N-channel power MOSFET, and current of 500mA as USB standard can be flown to the respective channels. And, over current detection circuit, thermal shutdown circuit, under voltage lockout and soft start circuit are built in.

●Features

- 1) Dual N-MOS high side switch
- 2) Continuous current load 0.5A
- 3) Control input logic
 - Active-Low
 - Active-High
- 4) Soft start circuit
- 5) Over current detection
- 6) Thermal shutdown
- 7) Under voltage lockout
- 8) Open drain error flag output
- 9) Reverse-current protection when switch off
- 10) Flag output delay filter built in

●Applications

USB hub in consumer appliances, Car accessory, PC, PC peripheral equipment, and so forth

●Lineup

Parameter	BD6512F	BD6513F	BD6516F	BD6517F	BD2052AFJ	BD2042AFJ	Unit
Over current detection	1.65	1.65	-	-	-	-	A
Output current at short	-	-	1.65	1.65	1.0	1.0	A
On resistance	100	100	110	110	100	100	mΩ
Control input logic	High	Low	High	Low	High	Low	-
Reverse current flow blocking at switch off	-	-	○	○	○	○	-
Flag output delay filter	-	-	○	○	○	○	-

●Absolute Maximum Ratings

◎BD6512F/BD6513F/BD6516F/BD6517F

Parameter	Symbol	Ratings	Unit
Supply voltage	V _{DD}	-0.3 to 6.0	V
CTRL voltage	V _{CTRL}	-0.3 to V _{DD} +0.3	V
Flag voltage	V _{FLAG}	-0.3 to 6.0	V
Output voltage	V _{OUT}	-0.3 to V _{DD} +0.3 (BD6512F/ BD6513F)	V
		-0.3 to 6.0 (BD6516F/ BD6517F)	V
Storage temperature	T _{STG}	-55 to 150	°C
Power dissipation *1	P _d	560 *1	mW

◎BD2042AFJ/ BD2052AFJ

Parameter	Symbol	Ratings	Unit
Supply voltage	V _{IN}	-0.3 to 6.0	V
EN,/EN voltage	V _{EN} , V _{/EN}	-0.3 to 6.0	V
/OC voltage	V _{/OC}	-0.3 to 6.0	V
/OC current	I _{S/OC}	10	mA
OUT voltage	V _{OUT}	-0.3 to 6.0	V
Storage temperature	T _{STG}	-55 to 150	°C
Power dissipation *1	P _d	560*1	mW

*1 This value decreases 4.48mW/°C above Ta=25°C.

* Resistance radiation design is not doing.

●Operating conditions

◎BD6512F/BD6513F/BD6516F/BD6517F

Parameter	Symbol	Ratings	Unit
Supply voltage	V _{DD}	3.0 to 5.5	V
Operation temperature	T _{OPR}	-25 to 85	°C
Continuous output current	I _{LO}	0 to 500	mA

◎BD2042AFJ/ BD2052AFJ

Parameter	Symbol	Ratings	Unit
Supply voltage	V _{IN}	2.7 to 5.5	V
Operation temperature	T _{OPR}	-40 to 85	°C
Continuous output current	I _{LO}	0 to 500	mA

●Electrical characteristics

◎BD6512F/BD6513F (V_{DD} =5V, Ta=25°C, unless otherwise specified.)

Parameter	Symbol	Limits			Unit	Condition
		Min.	Typ.	Max.		
Operating current	I _{DD}	-	85	120	μA	V _{CTRL} =5V(BD6512F), 0V(BD6513F) OUT=OPEN
		-	0.01	2	μA	V _{CTRL} =0V(BD6512F), 5V(BD6513F) OUT=OPEN
Control input voltage	V _{CTRL}	-	-	0.7	V	CTRL Low Level Input
		2.5	-	-	V	CTRL High Level Input
Control input current	I _{CTRL}	-1	0.01	1	μA	V _{CTRL} =0V or 5V
On resistance	R _{ON}	-	100	130	mΩ	V _{DD} =5V, I _{OUT} =500mA
		-	120	160	mΩ	V _{DD} =3.3V, I _{OUT} =500mA
Turn on delay	T _{RD}	100	600	2000	μs	R _L =10Ω
Turn on rise time	T _R	200	1500	6000	μs	R _L =10Ω
Turn off delay	T _{FD}	-	3	20	μs	R _L =10Ω
Turn off fall time	T _F	-	1	20	μs	R _L =10Ω
UVLO threshold voltage	V _{UVLOH}	2.3	2.5	2.7	V	V _{DD} increasing
	V _{UVLOL}	2.1	2.3	2.5	V	V _{DD} decreasing
Thermal shutdown threshold	T _{TS}	-	135	-	°C	
Flag output resistance	R _{FLAG}	-	16	40	Ω	I _{FLAG} =5mA
Flag off current	I _{FLAG}	-	0.01	1	μA	
Current limit threshold	I _{THLIM}	1.25	1.65	2.20	A	
Over current limit level	I _{LIM}	0.6	1.1	1.6	A	

◎BD6516F/BD6517F (V_{DD} =5V, Ta=25°C, unless otherwise specified.)

Parameter	Symbol	Limits			Unit	Condition
		Min.	Typ.	Max.		
Current consumption	I _{DD}	-	100	140	μA	V _{CTRL} =5V(BD6516F), 0V(BD6517F) OUT=OPEN
		-	0.01	2	μA	V _{CTRL} =0V(BD6516F), 5V(BD6517F) OUT=OPEN
CTRL input voltage	V _{CTRL}	-	-	0.7	V	Low level input voltage
		2.5	-	-	V	High level input voltage
CTRL input current	I _{CTRL}	-1	0.01	1	μA	V _{CTRL} =0V or 5V
FLAG output resistance	R _{FLAG}	-	250	450	Ω	I _{FLAG} =1mA
FLAG output leak current	I _{FLAG}	-	0.01	1	μA	V _{FLAG} =5V
FLAG output delay	T _{DFL}	-	1	4	ms	
ON resistance	R _{ON}	-	110	150	mΩ	V _{DD} =5V, I _{OUT} =500mA
		-	140	180	mΩ	V _{DD} =3.3V, I _{OUT} =500mA
Short circuit output current	I _{SC}	1.2	1.65	2.2	A	V _{OUT} =0V
Output leak current	I _{LEAK}	-	-	10	μA	V _{CTRL} =0V(BD6516F), 5V(BD6517F)
Thermal shutdown threshold	T _{TS}	-	135	-	°C	At T _j increase
Output rise time	T _{ON1}	100	1300	4000	μs	R _L =10Ω
Output turn on delay time	T _{ON2}	200	1500	6000	μs	R _L =10Ω
Output fall time	T _{OFF1}	-	1	20	μs	R _L =10Ω
Output turn off delay time	T _{OFF2}	-	3	20	μs	R _L =10Ω

©BD2042AFJ/BD2052AFJ ($V_{DD} = 5V$, $T_a = 25^\circ C$, unless otherwise specified.)

Parameter	Symbol	Limits			Unit	Condition
		Min.	Typ.	Max.		
Operating Current	I_{DD}	-	110	140	μA	$V_{/EN} = 0V$, OUT = OPEN (BD2042AFJ) $V_{/EN} = 5V$, OUT = OPEN (BD2052AFJ)
Standby Current	I_{STB}	-	0.01	1	μA	$V_{/EN} = 5V$, OUT = OPEN (BD2042AFJ) $V_{/EN} = 0V$, OUT = OPEN (BD2052AFJ)
/EN input voltage	$V_{/EN,EN}$	2.0	-	-	V	High input
		-	-	0.8	V	Low input
		-	-	0.4	V	Low input $2.7V \leq V_{IN} \leq 4.5V$
/EN input current	$I_{/EN,EN}$	-1.0	0.01	1.0	μA	$V_{/EN,EN} = 0V$ or $V_{/EN,EN} = 5V$
/OC output LOW voltage	$V_{/OC}$	-	-	0.5	V	$I_{/OC} = 5mA$
/OC output leak current	$I_{L/OC}$	-	0.01	1	μA	$V_{/OC} = 5V$
ON resistance	R_{ON}	-	100	130	$m\Omega$	$I_{OUT} = 500mA$
Output current at short	I_{SC}	0.7	1.0	1.3	A	$V_{IN} = 5V$, $V_{OUT} = 0V$, $C_L = 100\mu F$ (RMS)
Output rise time	T_{ON1}	-	1.8	10	ms	$R_L = 10\Omega$, $C_L = OPEN$
Output turn on time	T_{ON2}	-	2.1	20	ms	
Output fall time	T_{OFF1}	-	1	20	μs	
Output turn off time	T_{OFF2}	-	3	40	μs	
UVLO threshold	V_{TUVH}	2.1	2.3	2.5	V	Increasing V_{IN}
	V_{TUVL}	2.0	2.2	2.4	V	Decreasing V_{IN}

● Measurement circuit

©BD6512F/ BD6513F/ BD6516F/ BD6517F

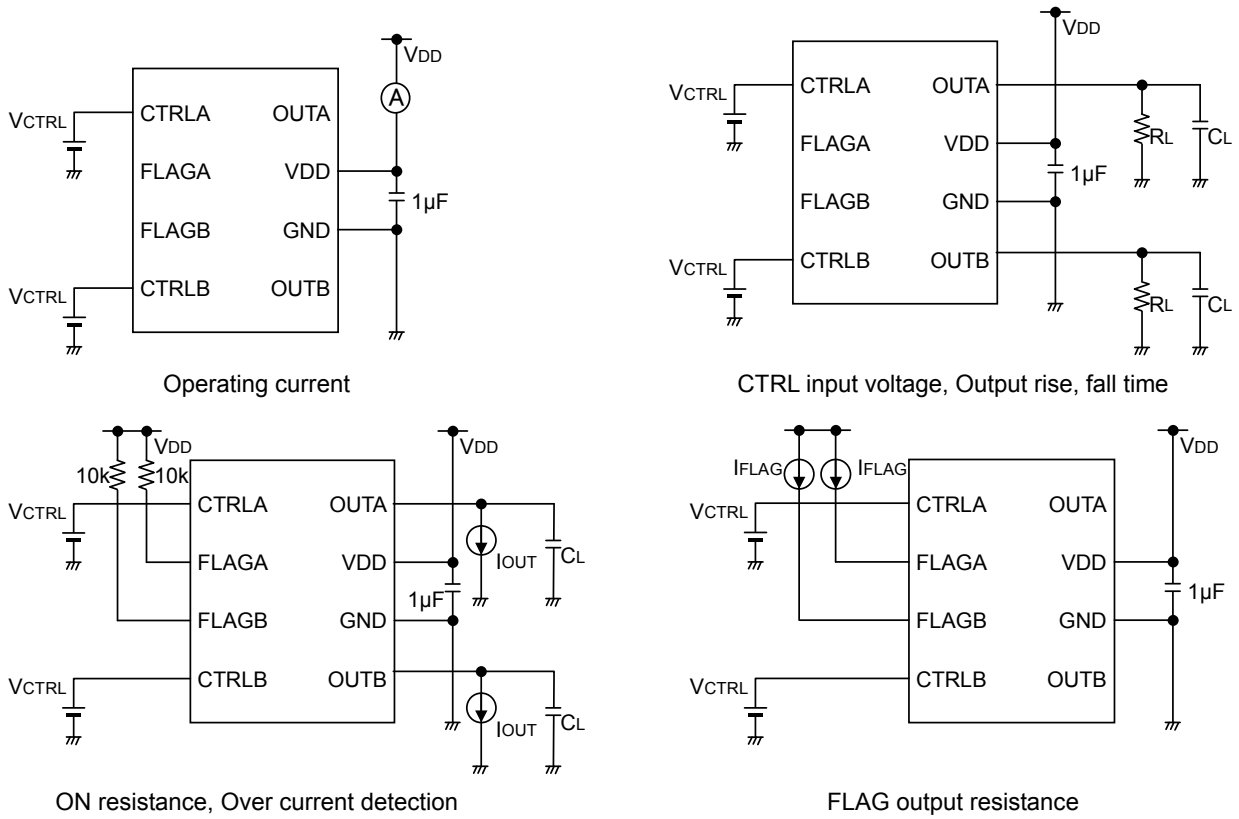

©BD2042AFJ/ BD2052AFJ

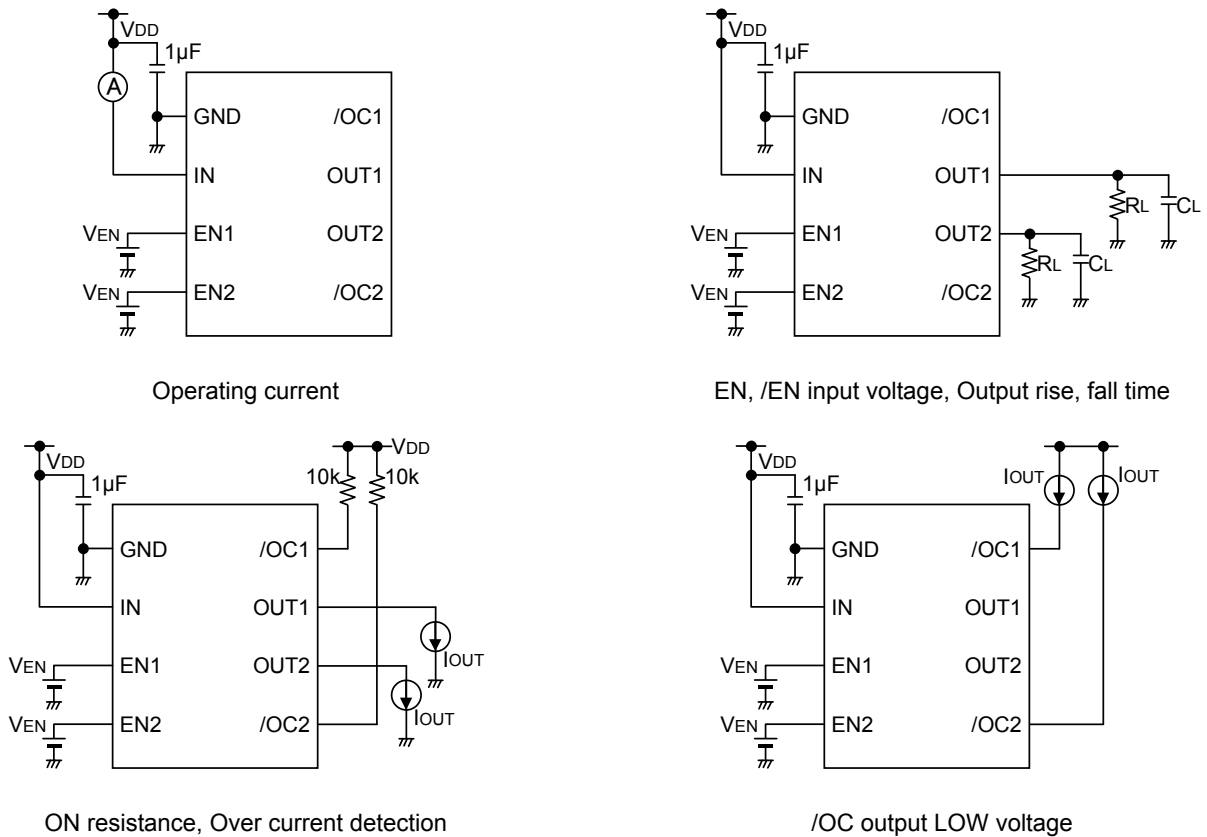
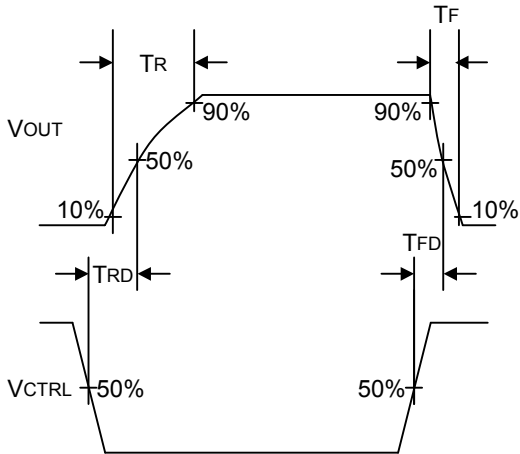

Fig.1 Measurement circuit

● Timing diagram

©BD6513F



©BD6512F

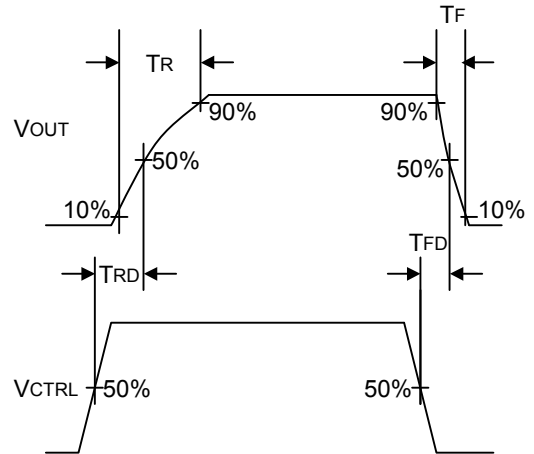

©BD6515F/BD2042AFJ

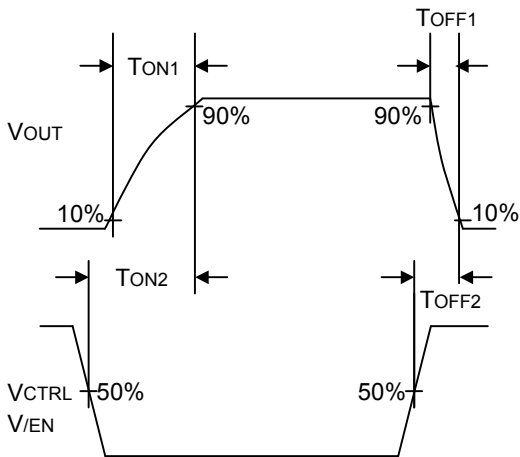

©BD6516F/BD2052AFJ

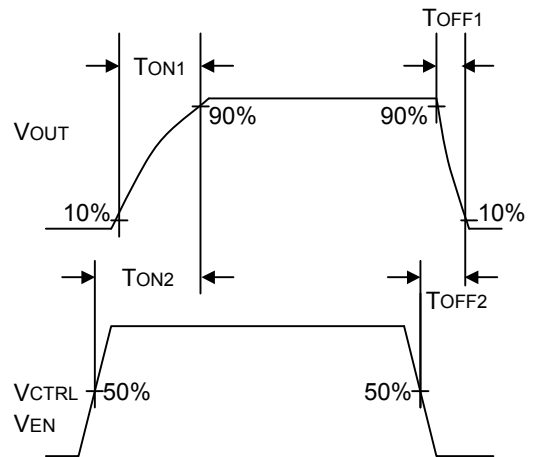

Fig.2 Timing diagram

●Reference data

◎BD6512F/ BD6513F

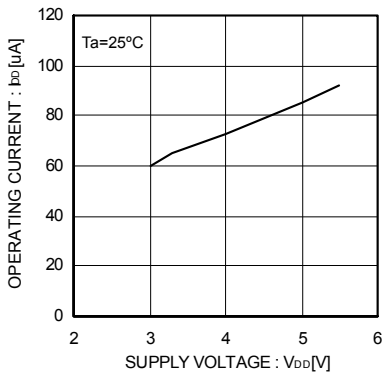

Fig.3 Operating current

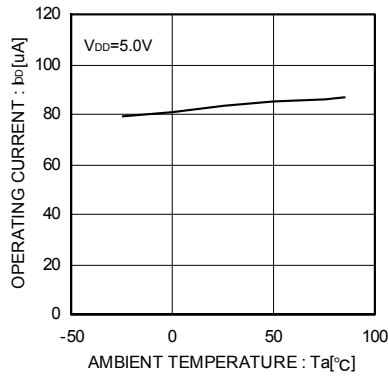

Fig.4 Operating current

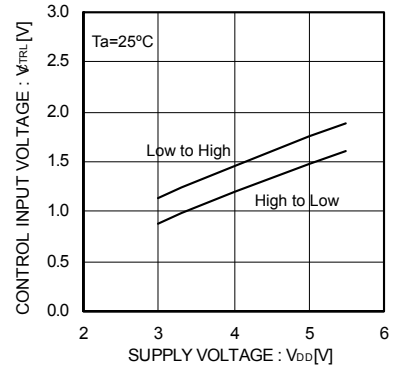

Fig.5 CTRL input voltage

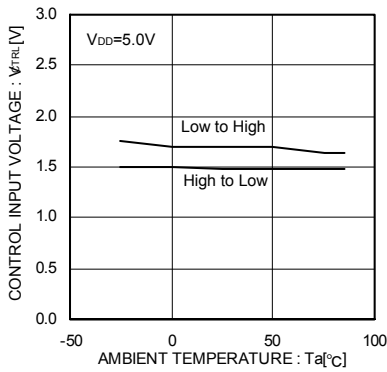

Fig.6 CTRL input voltage

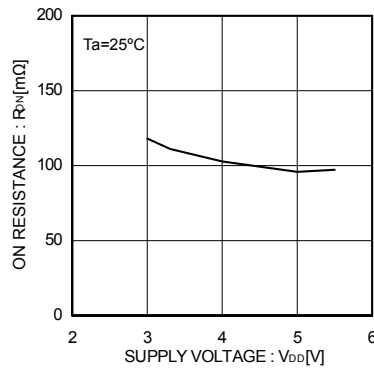

Fig.7 ON resistance

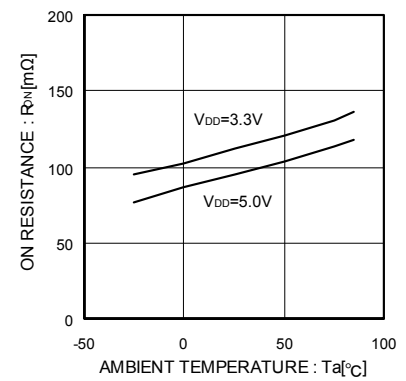

Fig.8 ON resistance

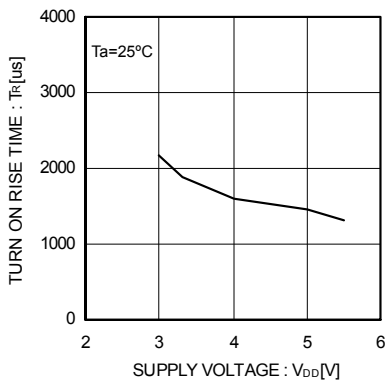

Fig.9 Output rise time

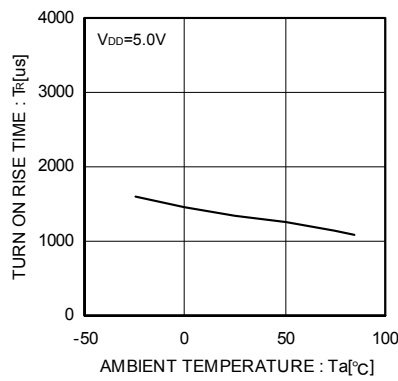

Fig.10 Output rise time

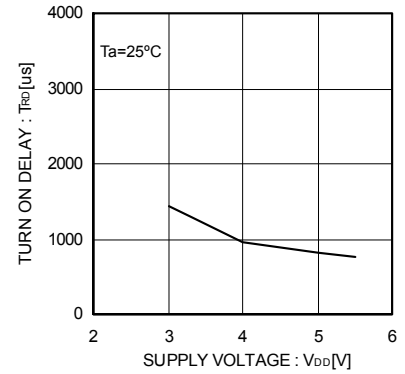

Fig.11 Output rise delay time

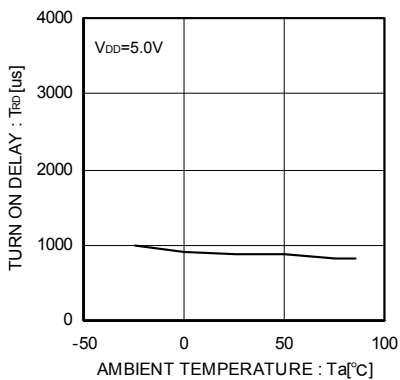

Fig.12 Output rise delay time

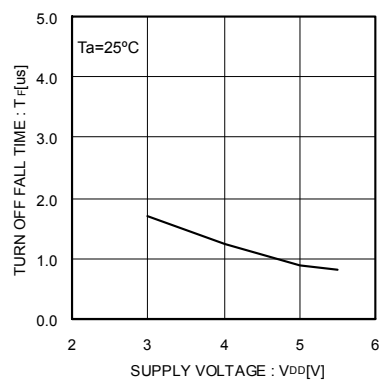

Fig.13 Output fall time

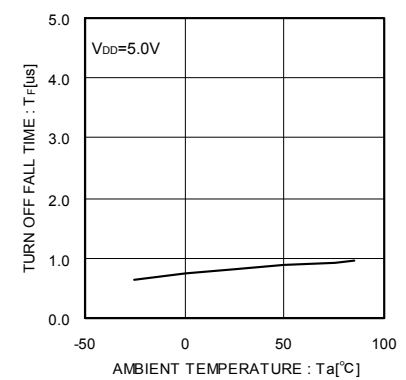

Fig.14 Output fall time

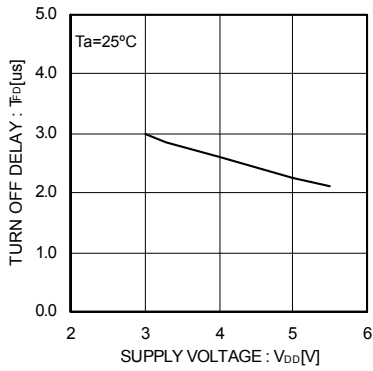

Fig.15 Output fall delay time

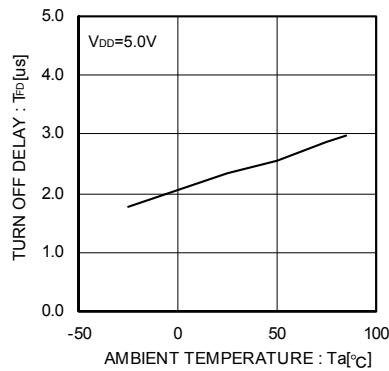

Fig.16 Output fall delay time

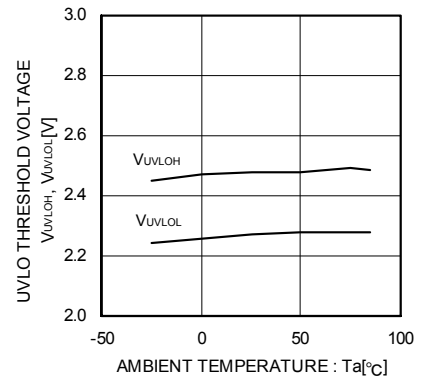

Fig.17 UVLO threshold voltage

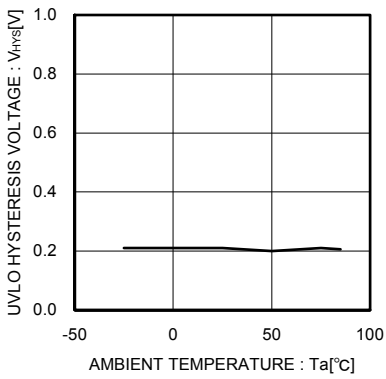

Fig.18 UVLO hysteresis voltage

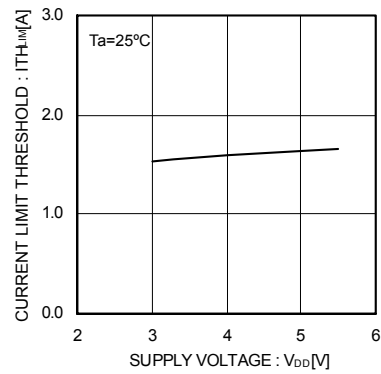

Fig.19 Over current threshold

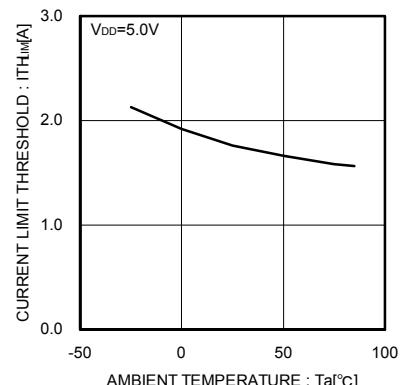

Fig.20 Over current threshold

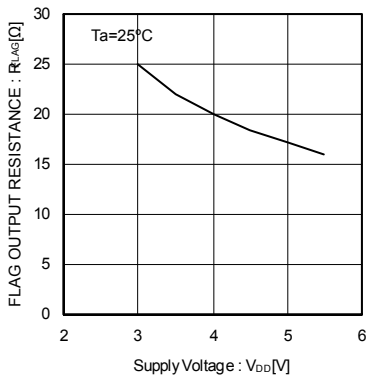

Fig.21 Flag output resistance

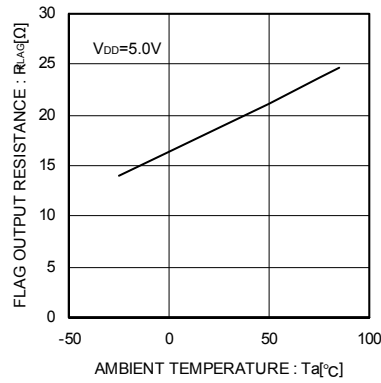

Fig.22 Flag output resistance

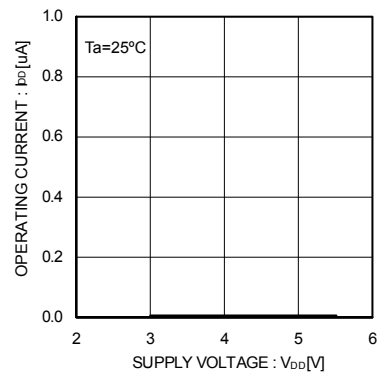

Fig.23 Operating current CTRL Disable

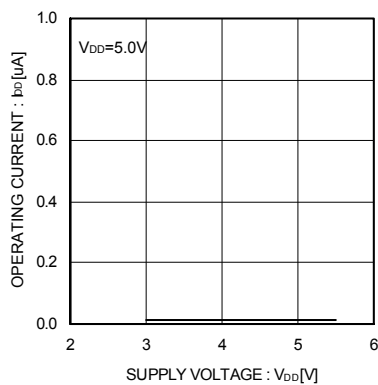

Fig.24 Operating current CTRL Disable

●Reference data

◎BD6516F/ BD6517F

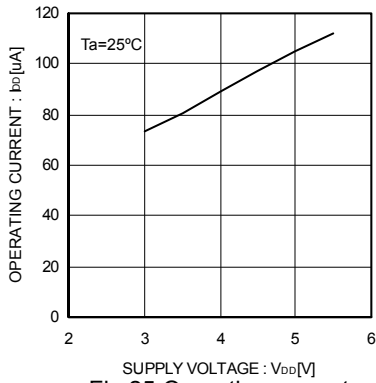

Fig.25 Operating current

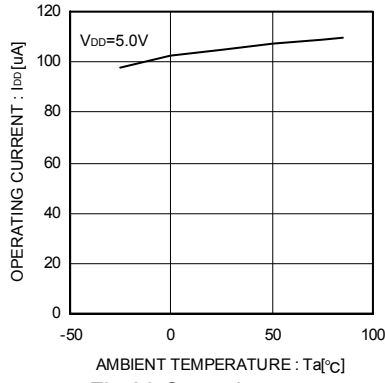

Fig.26 Operating current

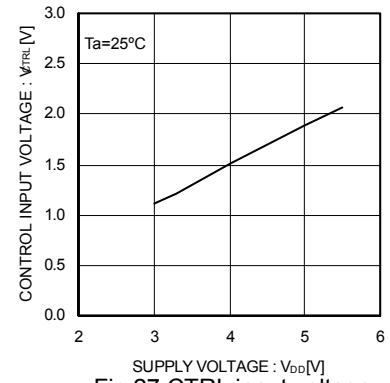

Fig.27 CTRL input voltage (BD6516F)

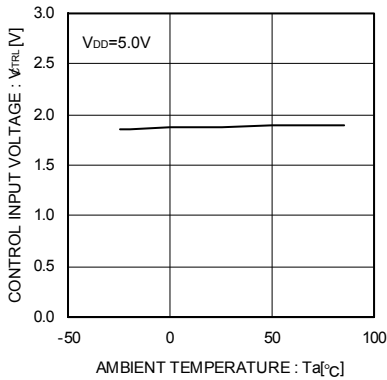

Fig.28 CTRL input voltage (BD6516F)

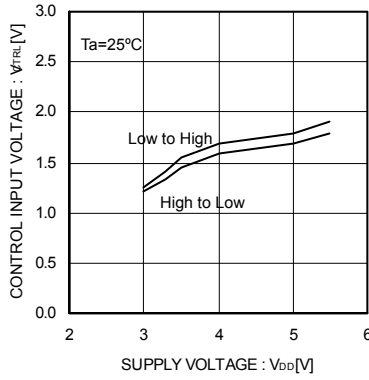

Fig.29 CTRL input voltage (BD6517F)

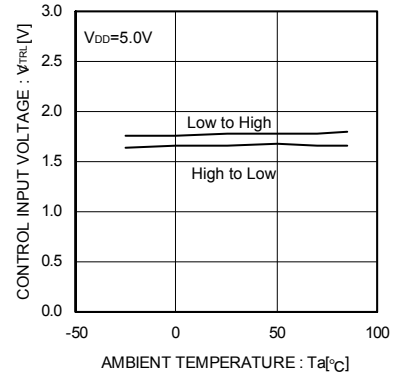

Fig.30 CTRL input voltage (BD6517F)

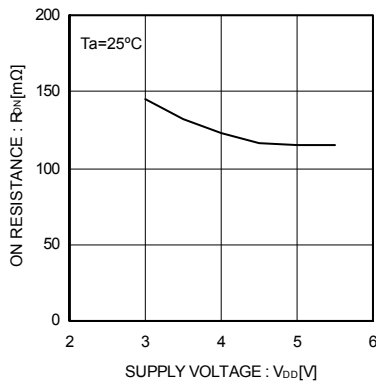

Fig.31 ON resistance

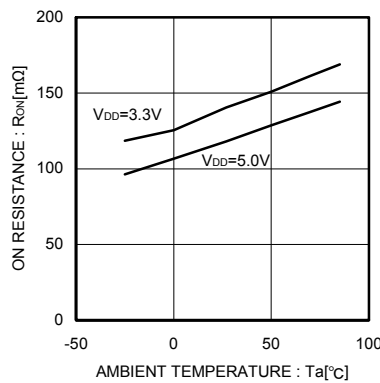

Fig.32 ON resistance

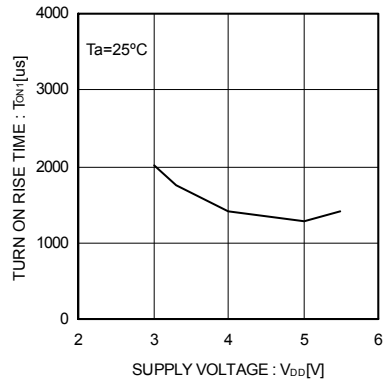

Fig.33 Output rise time

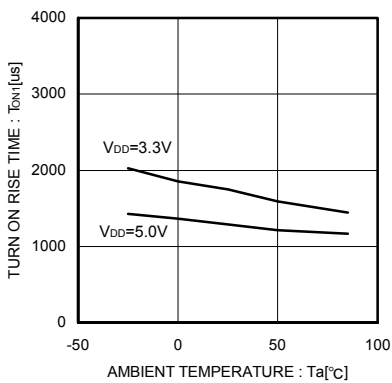

Fig.34 Output rise time

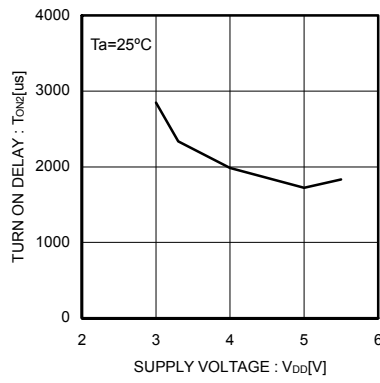

Fig.35 Output rise delay time

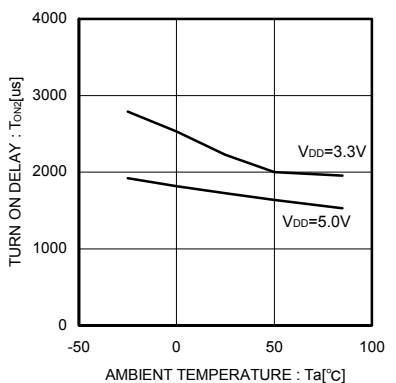

Fig.36 Output rise delay time

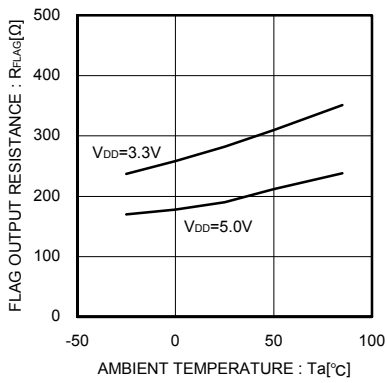

Fig.37 Flag output resistance

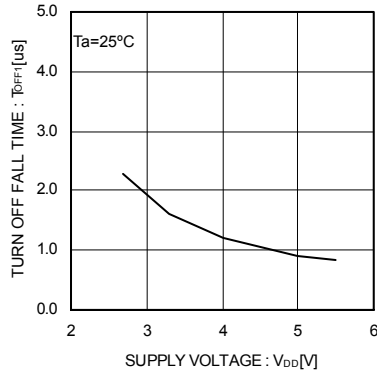

Fig.38 Output fall time

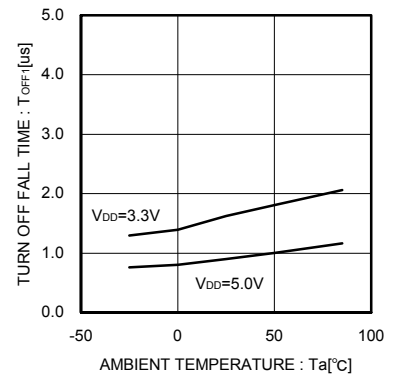

Fig.39 Output fall time

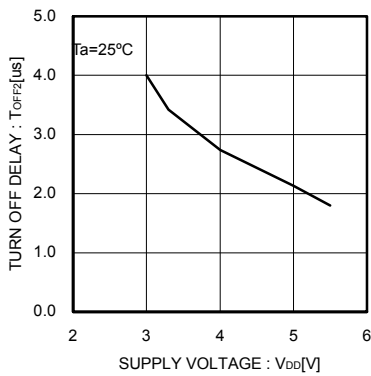

Fig.40 Output fall delay time

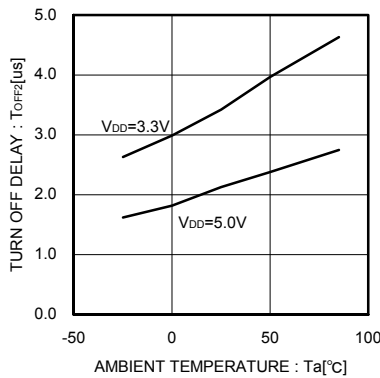

Fig.41 Output fall delay time

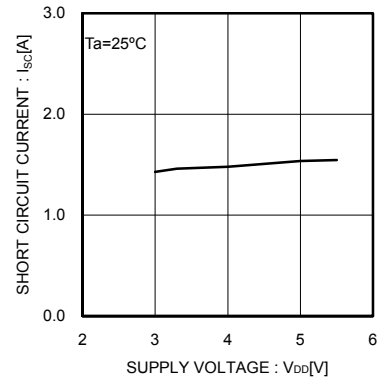

Fig.42 Shortcircuit output current

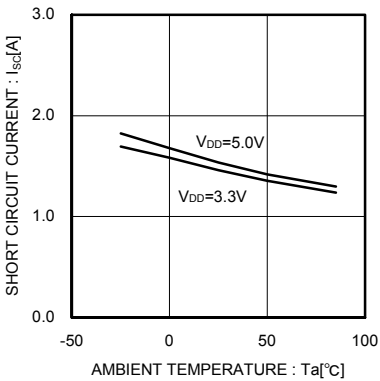

Fig.43 Shortcircuit output current

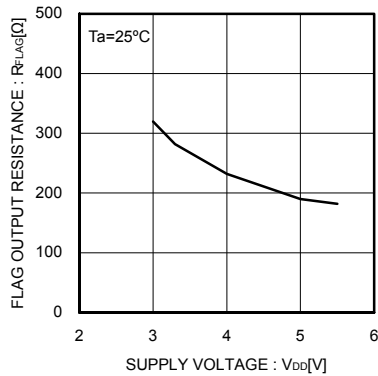

Fig.44 Flag output resistance

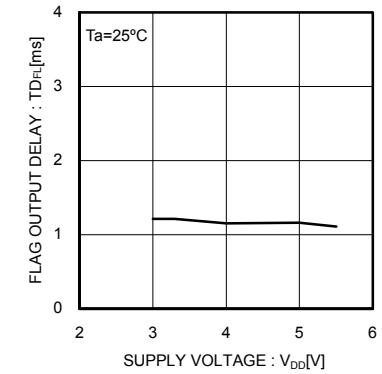

Fig.45 Flag output delay

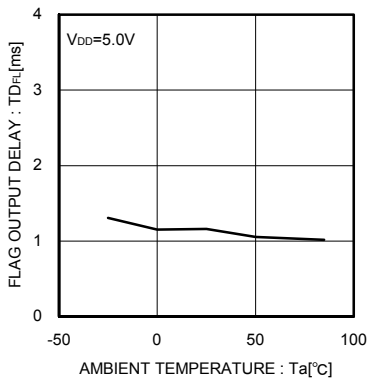

Fig.46 Flag output delay

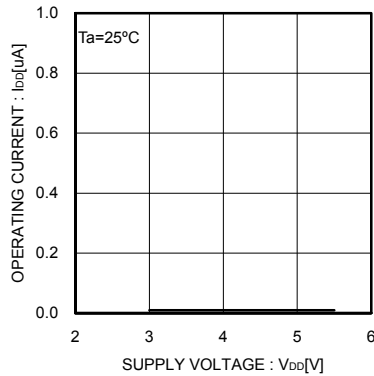

Fig.47 Operating current CTRL Disable

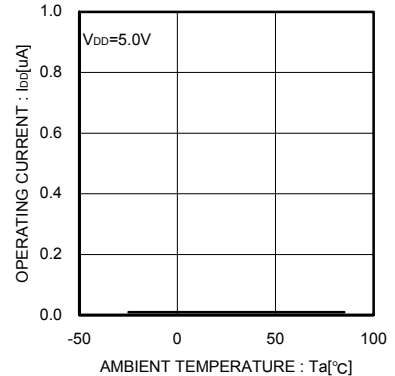

Fig.48 Operating current CTRL Disable

●Reference data

©BD2042AFJ/ BD2052AFJ

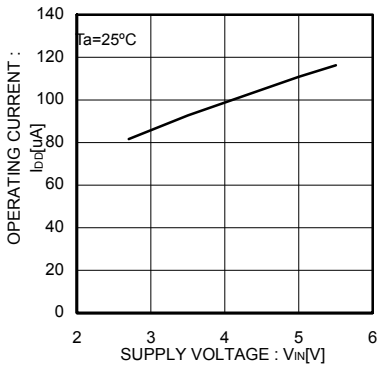

Fig.49 Operating current EN,/EN Enable

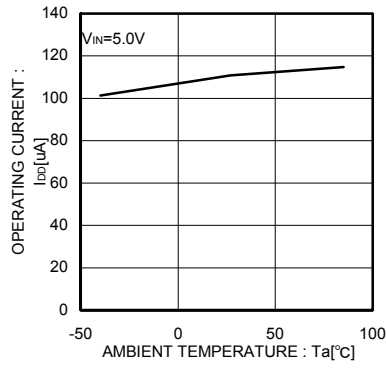

Fig.50 Operating current EN,/EN Enable

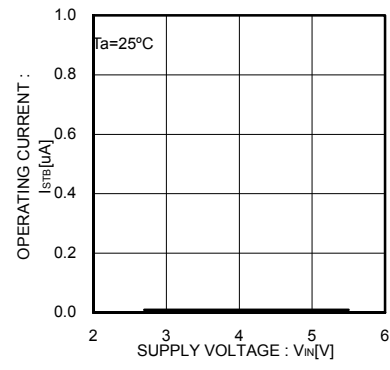

Fig.51 Operating current EN,/EN Disable

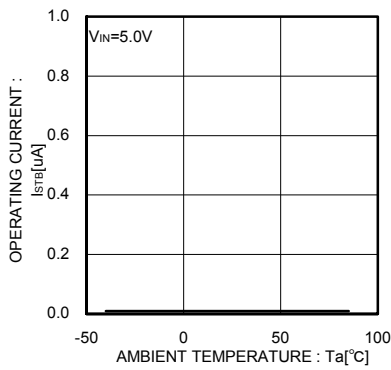

Fig.52 Operating current EN,/EN Disable

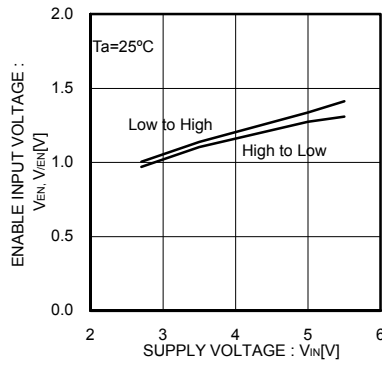

Fig.53 EN,/EN input voltage

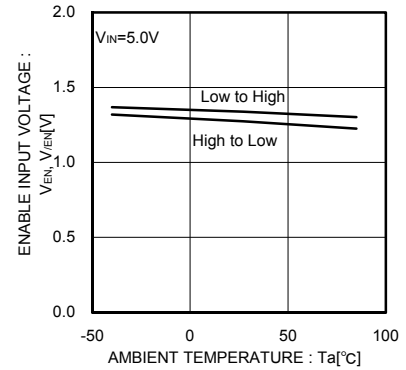

Fig.54 EN,/EN input voltage

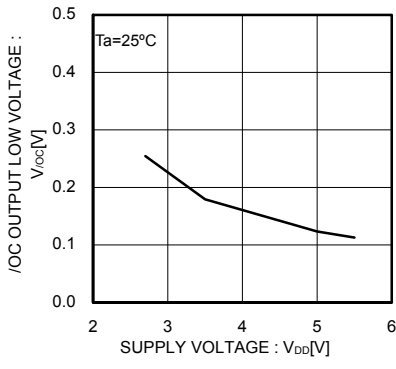

Fig.55 /OC output LOW voltage

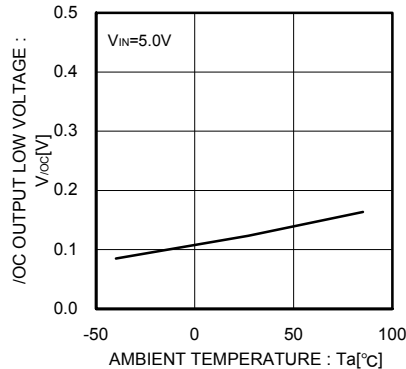

Fig.56 /OC output LOW voltage

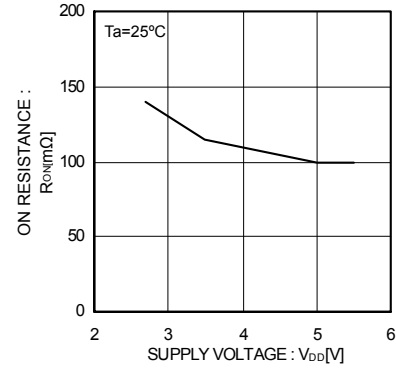

Fig.57 ON resistance

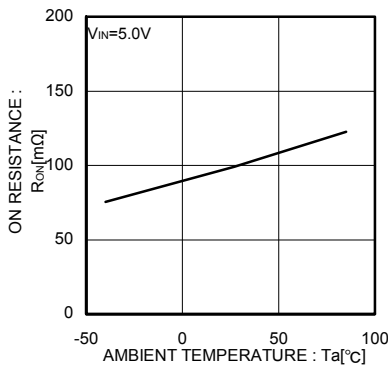

Fig.58 ON resistance

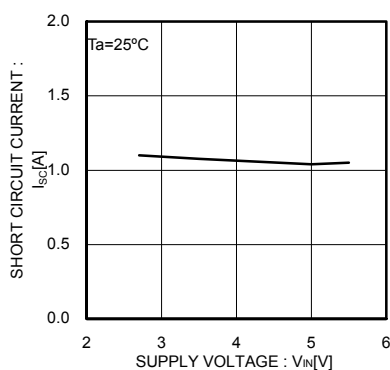

Fig.59 Output current at shortcircuit

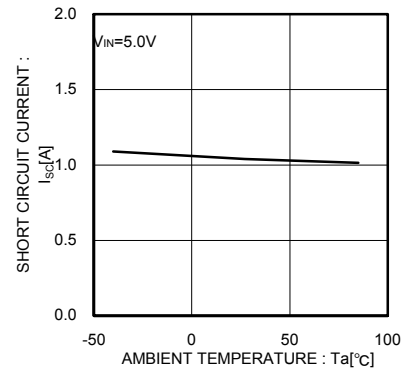

Fig.60 Output current at shortcircuit

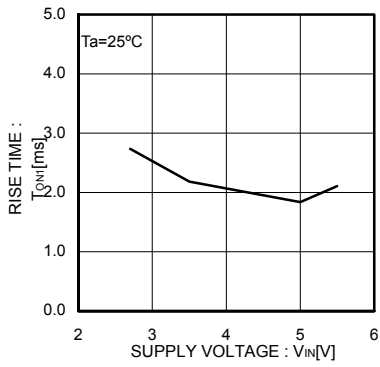

Fig.61 Output rise time

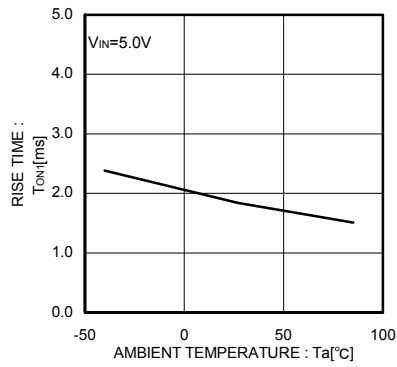

Fig.62 Output rise time

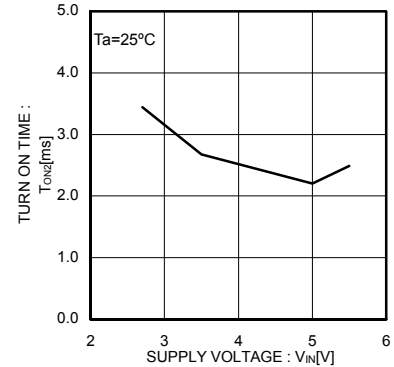

Fig.63 Output turn on time

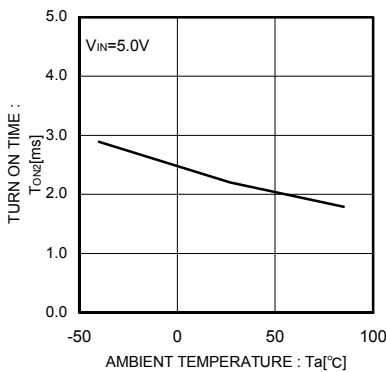

Fig.64 Output turn on time

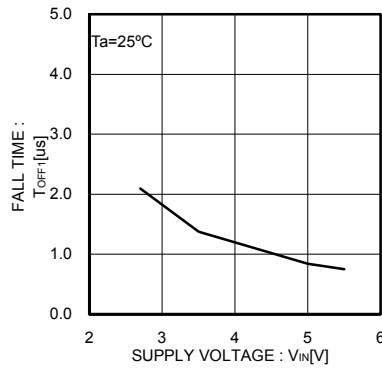

Fig.65 Output fall time

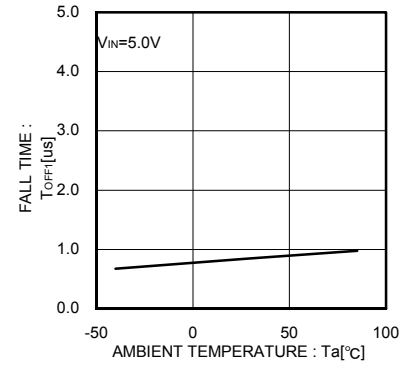

Fig.66 Output fall time

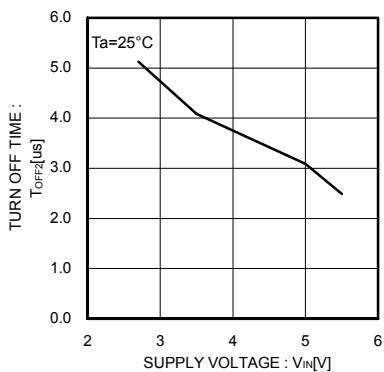

Fig.67 Output turn off time

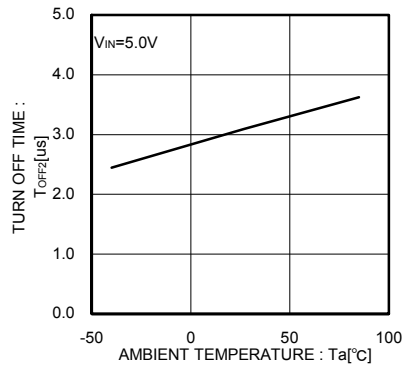

Fig.68 Output turn off time

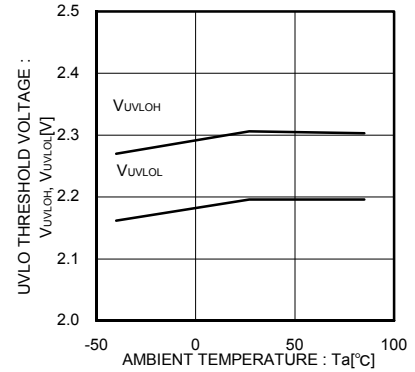

Fig.69 UVLO threshold voltage

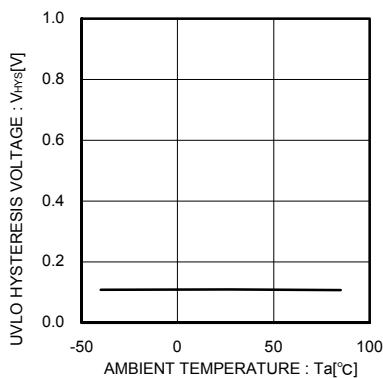

Fig.70 UVLO hysteresis voltage

● Waveform data

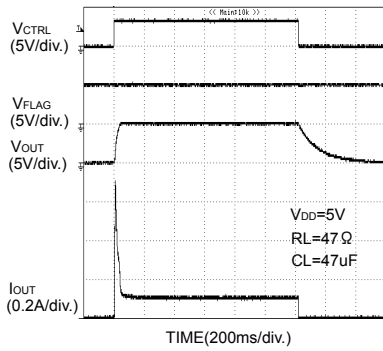

Fig.71 Output rise, fall characteristic (BD6512F)

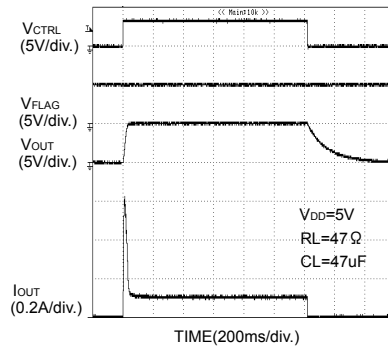

Fig.72 Output rise, fall characteristic (BD6516F)

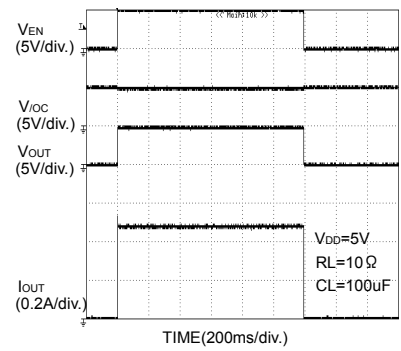

Fig.73 Output rise, fall characteristic (BD2052AFJ)

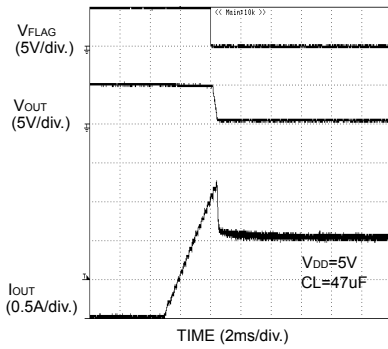

Fig.74 Over current response Ramped load (BD6512F)

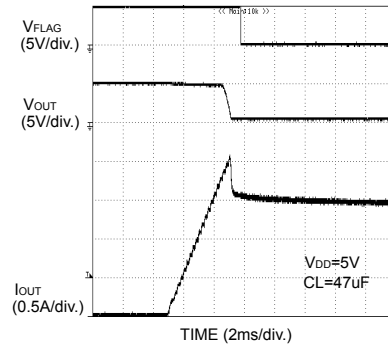

Fig.75 Over current response Ramped load (BD6516F)

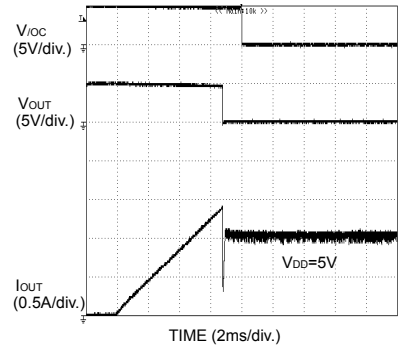

Fig.76 Over current response Ramped load (BD2052AFJ)

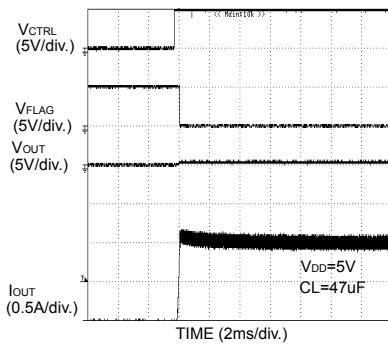

Fig.77 Over current response Enable to shortcircuit (BD6512F)

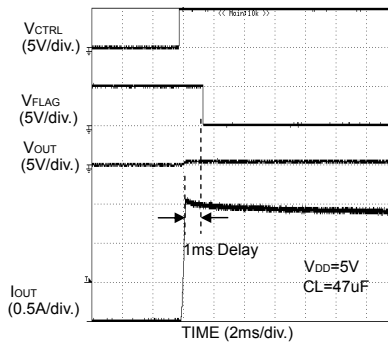

Fig.78 Over current response Enable to shortcircuit (BD6516F)

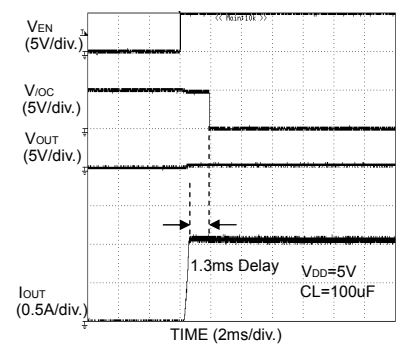

Fig.79 Over current response Enable to shortcircuit (BD2052AFJ)

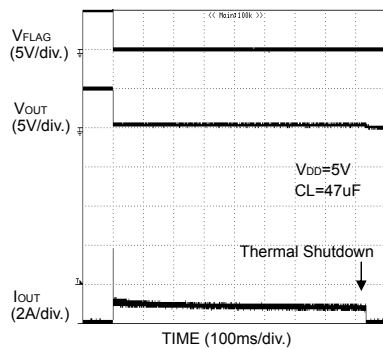

Fig.80 Over current response Output shortcircuit at Enable (BD6512F)

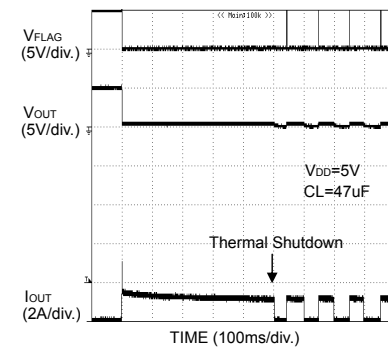

Fig.81 Over current response Output shortcircuit at Enable (BD6516F)

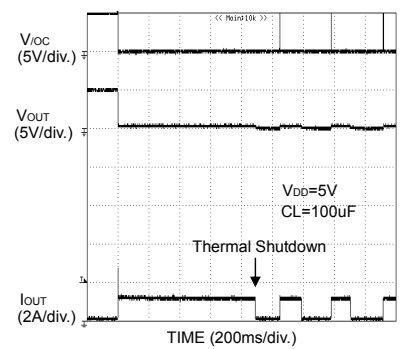

Fig.82 Over current response Output shortcircuit at Enable (BD2052AFJ)

Regarding the output rise/fall and over current detection characteristics of BD6513F, BD6517F, BD2042AFJ refer to the characteristic of BD6512F, BD6516F, BD2052AFJ.

●Block diagram

©BD6512F/ BD6513F/ BD6516F/ BD6517F

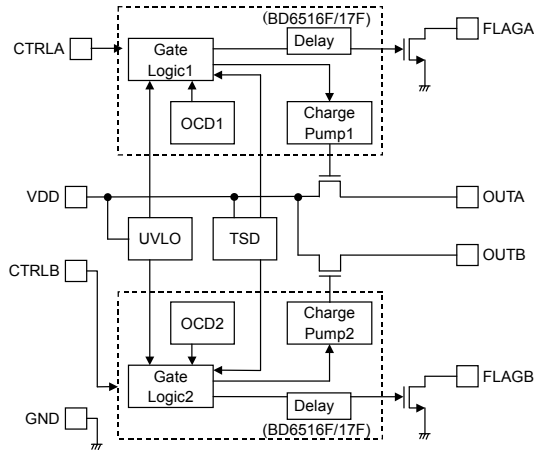

Fig.83 Block diagram

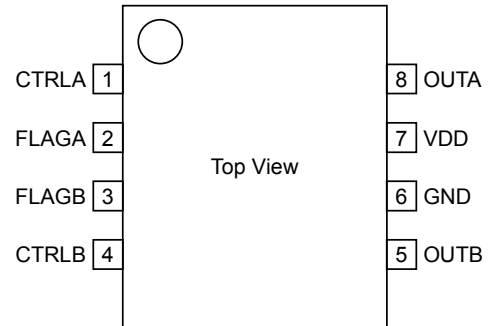

Fig.84 Pin Configuration

●Pin description

©BD6512F/ BD6513F/ BD6516F/ BD6517F

Pin No.	Symbol	I / O	Pin function
1, 4	CTRLA CTRLB	I	Enable input. Switch on at Low level. (BD6513F/BD6517F) Switch on at High level. (BD6512F/BD6516F) High level input > 2.5V, Low level input < 0.7V.
2, 3	FLAGA FLAGB	O	Error flag output. Low at over current, thermal shutdown. Open drain output.
5, 8	OUTB OUTA	O	Switch output.
6	GND	I	Ground.
7	VDD	I	Power supply input. Input terminal to the switch and power supply input terminal of the internal circuit.

●I/O circuit

©BD6512F/ BD6513F/ BD6516F/ BD6517F

Symbol	Pin No.	Equivalent circuit (BD6512F/ BD6513F)	Equivalent circuit (BD6516F/ BD6517F)
CTRLA CTRLB	1, 4		
FLAGA FLAGB	2, 3		
OUTA OUTB	5, 8		

●Block diagram

©BD2042AFJ/BD2052AFJ

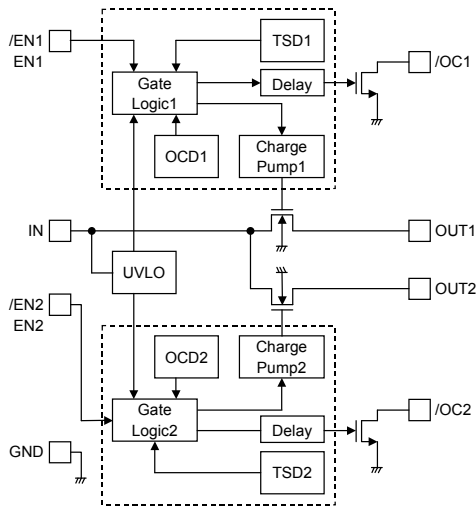

Fig.85 Block diagram

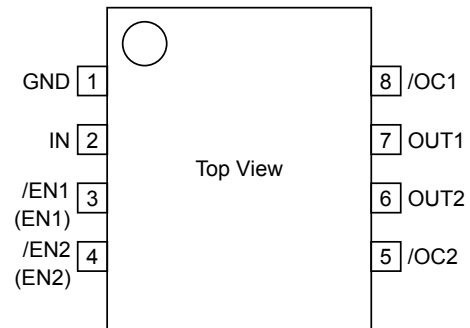

Fig.86 Pin Configuration

●Pin description

©BD2042AFJ/BD2052AFJ

Pin No.	Symbol	I / O	Pin function
1	GND	I	Ground.
2	IN	I	Power supply input. Input terminal to the switch and power supply input terminal of the internal circuit.
3, 4	/EN, EN	I	Enable input. Switch on at Low level. (BD2042AFJ) Switch on at High level. (BD2052AFJ) High level input > 2.0V, Low level input < 0.8V.
5, 8	/OC	O	Error flag output. Low at over current, thermal shutdown. Open drain output.
6, 7	OUT	O	Switch output.

●I/O circuit

©BD2042AFJ/BD2052AFJ

Symbol	Pin No	Equivalent circuit
/EN1(EN1) /EN2(EN2)	3, 4	
/OC1 /OC2	5, 8	
OUT1 OUT2	6, 7	

●Functional description

1. Switch operation

VDD(IN) pin and OUT pin are connected to the drain and the source of switch MOSFET respectively. And the VDD(IN) pin is used also as power source input to internal control circuit.

When the switch is turned on from CTRL(EN) control input, VDD(IN) and OUT is connected. In a normal condition, current flows from VDD to OUT. If voltage of OUT is higher than VDD, current flows from OUT to VDD, since the switch is bidirectional.

◎BD6512F/ BD6513F

There is a parasitic diode between the drain and the source of switch MOSFET. Therefore, even when the switch is off, if the voltage of OUT is higher than that of VDD, current flows from OUT to VDD.

◎BD6516F/BD6517F/BD2042AFJ/BD2052AFJ

There is not parasitic diode, it is possible to prevent current from flowing reversely from OUT to VDD.

2. Thermal shutdown (TSD)

Thermal shut down circuit turns off the switch and outputs an error flag when the junction temperature in chip exceeds a threshold temperature. The thermal shut down circuit works when either of two control signals is active.

In BD6512F/BD6513F/BD6516F/BD6517F, the switches of both OUTA and OUTB become off and error flags are output to the both. BD2042AFJ/ BD2052AFJ have dual thermal shutdown threshold. Since thermal shutdown works at a lower junction temperature when an overcurrent occurs, only the switch of an overcurrent state become off and error flag is output.

◎BD6512F/BD6513F

The switch off status of the thermal shut down is latched. Therefore, even when the junction temperature goes down, switch off and error flag output status are maintained. To release the latch, it is necessary to input a signal to switch off to CTRL pin or make UVLO status. When the switch on signal is input or UVLO is released, the switch on and error flag output are recovered.

◎BD6516F/BD6517F/BD2042AFJ/BD2052AFJ

Thermal shut down action has hysteresis. Therefore, when the junction temperature goes down, switch on and error flag output automatically recover. However, until cause of junction temperature increase such as output shortcircuit is removed or the switch is turned off, thermal shut down detection and recovery are repeated.

3. Over current detection, limit circuit

The over current detection circuit limits current and outputs error flag when current flowing in each switch MOSFET exceeds a specified value. There are three types of response against over current. The over current detection, limit circuit works when the switch is on (CTRL · EN signal is active).

3-1 When the switch is turned on while the output is in shortcircuit status

When the switch is turned on while the output is in shortcircuit status, the switch become current limit mode soon.

3-2 When the output shortcircuits while the switch is on

When the output shortcircuits or large capacity is connected while the switch is on, very large current flows until the over current limit circuit responds. When the current detection, limit circuit works, current limitation is carried out.

3-3 When the output current increases gradually

When the output current increases gradually, current limitation does not work until the output current exceeds the over current detection value. When it exceeds the detection value, current limitation is carried out.

4. Under voltage lockout(UVLO)

When the supply voltage is below UVLO threshold level, UVLO circuit turns off switch to prevent malfunction. The UVLO circuit works when either of two control signals is active.

◎BD6512F/BD6513F

UVLO circuit prevents the switch from turning on until the V_{DD} exceeds 2.5V(Typ.). If the V_{DD} drops below 2.3V(Typ.) while the switch turns on, then UVLO shuts off the switch.

◎BD2042AFJ/BD2052AFJ

UVLO circuit prevents the switch from turning on until the V_{IN} exceeds 2.3V(Typ.). If the V_{IN} drops below 2.2V(Typ.) while the switch turns on, then UVLO shuts off the switch. UVLO has hysteresis of a 100mV(Typ).

5. Error flag output

Error flag output is N-MOS open drain output.

◎BD6512F/BD6513F

At detection of over current detection, thermal shutdown, UVLO, Low level is output.

◎BD6516F/BD6517F/BD2042AFJ/BD2052AFJ

At detection of over current detection, thermal shutdown, Low level is output. Error flag output at over current detection has delay filter. This delay filter prevents instantaneous current detection such as inrush current at switch on, hot plug from being informed to outside.

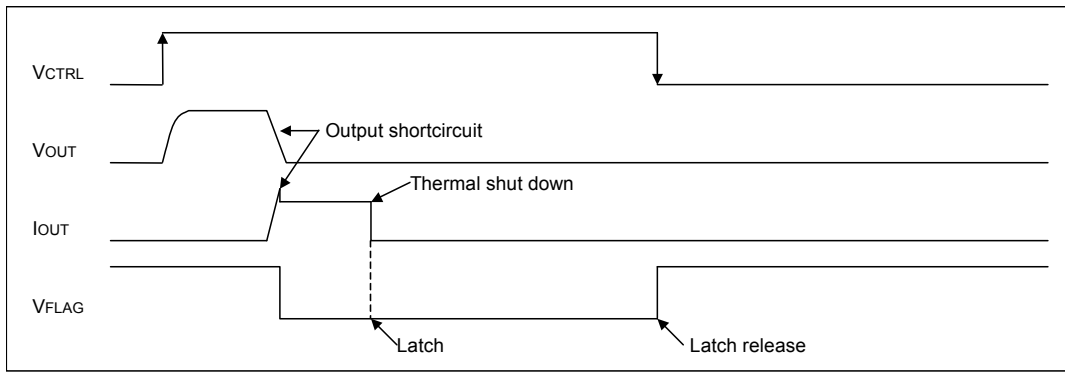

Fig.87 BD6512F/ BD6513F over current detection, thermal shutdown timing (V_{CTRL} of BD6513F active Low)

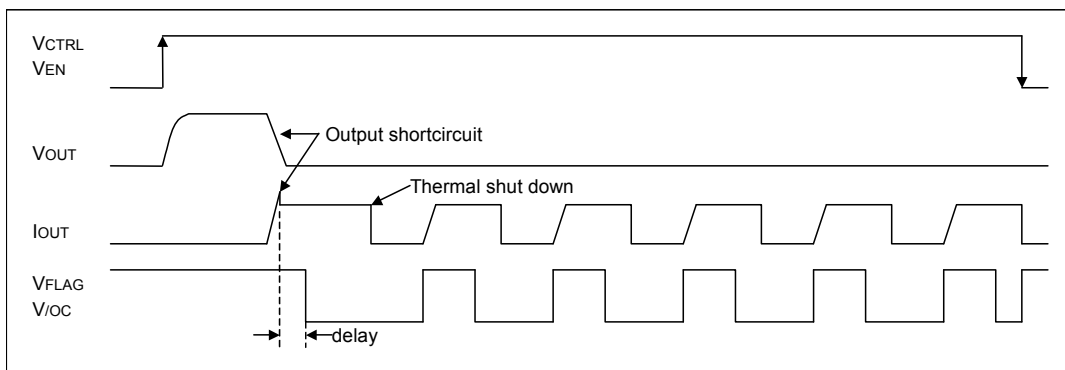

Fig.88 BD6516F/ BD6517F/BD2042AFJ/ BD2052AFJ over current detection, thermal shutdown timing (V_{CTRL}, V_{EN} of BD6517F/BD2042AFJ active Low)

● Typical application circuit

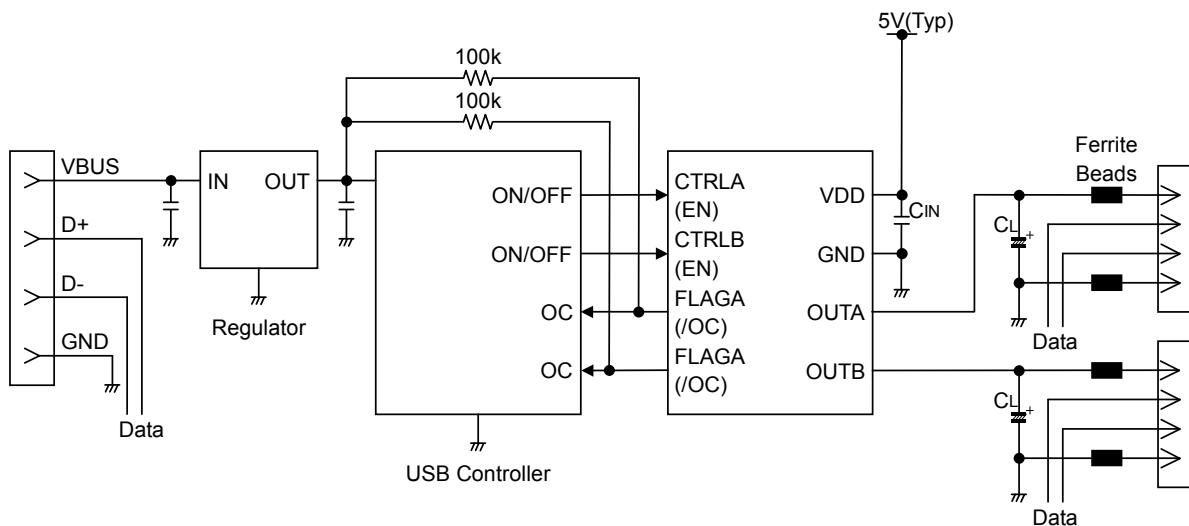

Fig.89 Typical application circuit

●Application information

When excessive current flows owing to output shortcircuit or so, ringing occurs by inductance of power source line to IC, and may cause bad influences upon IC operations. In order to avoid this case, connect a bypass capacitor by VDD pin and GND pin of IC. 1uF or higher is recommended.

Pull up flag output by resistance 10kΩ ~ 100kΩ.

Set up value which satisfies the application as CL and Ferrite Beads.

This system connection diagram doesn't guarantee operating as the application.

The external circuit constant and so on is changed and it uses, in which there are adequate margins by taking into account external parts or dispersion of IC including not only static characteristics but also transient characteristics.

In BD6512F/BD6513F, there are cases where over current detection error flag is output to inrush current at switch on or at insertion of active line of peripheral devices. In the case of erroneous detection inBD6512F/BD6513F, use RC filter shown in Fig. 90 for FLAG output.

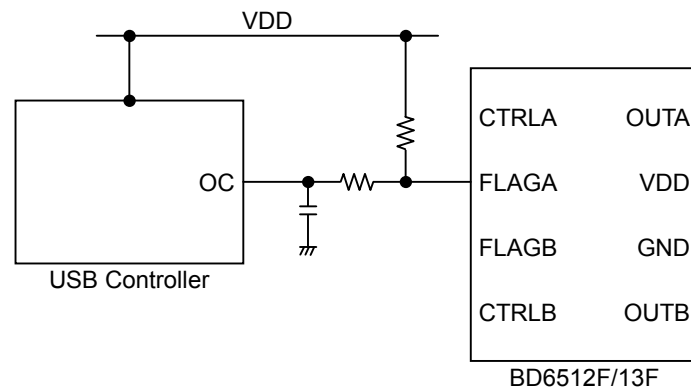

Fig.90 FLAG output RC filter

●Thermal derating characteristic (SOP8, SOP-J8)

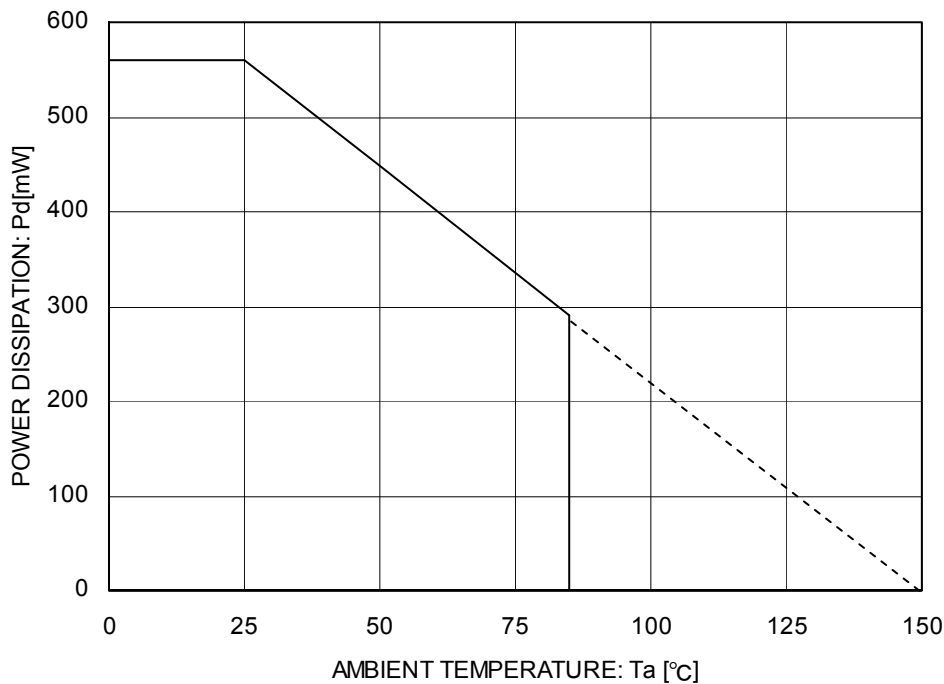

Fig.92 Power dissipation curve

●Notes for use

- (1) Absolute Maximum Ratings
An excess in the absolute maximum ratings, such as supply voltage, temperature range of operating conditions, etc., can break down devices, thus making impossible to identify breaking mode such as a short circuit or an open circuit. If any special mode exceeding the absolute maximum ratings is assumed, consideration should be given to take physical safety measures including the use of fuses, etc.
- (2) Operating conditions
These conditions represent a range within which characteristics can be provided approximately as expected. The electrical characteristics are guaranteed under the conditions of each parameter.
- (3) Reverse connection of power supply connector
The reverse connection of power supply connector can break down ICs. Take protective measures against the breakdown due to the reverse connection, such as mounting an external diode between the power supply and the IC's power supply terminal.
- (4) Power supply line
Design PCB pattern to provide low impedance for the wiring between the power supply and the GND lines. In this regard, for the digital block power supply and the analog block power supply, even though these power supplies has the same level of potential, separate the power supply pattern for the digital block from that for the analog block, thus suppressing the diffraction of digital noises to the analog block power supply resulting from impedance common to the wiring patterns. For the GND line, give consideration to design the patterns in a similar manner. Furthermore, for all power supply terminals to ICs, mount a capacitor between the power supply and the GND terminal. At the same time, in order to use an electrolytic capacitor, thoroughly check to be sure the characteristics of the capacitor to be used present no problem including the occurrence of capacity dropout at a low temperature, thus determining the constant.
- (5) GND voltage
Make setting of the potential of the GND terminal so that it will be maintained at the minimum in any operating state. Furthermore, check to be sure no terminals are at a potential lower than the GND voltage including an actual electric transient.
- (6) Short circuit between terminals and erroneous mounting
In order to mount ICs on a set PCB, pay thorough attention to the direction and offset of the ICs. Erroneous mounting can break down the ICs. Furthermore, if a short circuit occurs due to foreign matters entering between terminals or between the terminal and the power supply or the GND terminal, the ICs can break down.
- (7) Operation in strong electromagnetic field
Be noted that using ICs in the strong electromagnetic field can malfunction them.
- (8) Inspection with set PCB
On the inspection with the set PCB, if a capacitor is connected to a low-impedance IC terminal, the IC can suffer stress. Therefore, be sure to discharge from the set PCB by each process. Furthermore, in order to mount or dismount the set PCB to/from the jig for the inspection process, be sure to turn OFF the power supply and then mount the set PCB to the jig. After the completion of the inspection, be sure to turn OFF the power supply and then dismount it from the jig. In addition, for protection against static electricity, establish a ground for the assembly process and pay thorough attention to the transportation and the storage of the set PCB.
- (9) Input terminals
In terms of the construction of IC, parasitic elements are inevitably formed in relation to potential. The operation of the parasitic element can cause interference with circuit operation, thus resulting in a malfunction and then breakdown of the input terminal. Therefore, pay thorough attention not to handle the input terminals, such as to apply to the input terminals a voltage lower than the GND respectively, so that any parasitic element will operate. Furthermore, do not apply a voltage to the input terminals when no power supply voltage is applied to the IC. In addition, even if the power supply voltage is applied, apply to the input terminals a voltage lower than the power supply voltage or within the guaranteed value of electrical characteristics.
- (10) Ground wiring pattern
If small-signal GND and large-current GND are provided, It will be recommended to separate the large-current GND pattern from the small-signal GND pattern and establish a single ground at the reference point of the set PCB so that resistance to the wiring pattern and voltage fluctuations due to a large current will cause no fluctuations in voltages of the small-signal GND. Pay attention not to cause fluctuations in the GND wiring pattern of external parts as well.
- (11) External capacitor
In order to use a ceramic capacitor as the external capacitor, determine the constant with consideration given to a degradation in the nominal capacitance due to DC bias and changes in the capacitance due to temperature, etc.
- (12) Thermal shutdown circuit (TSD)
When junction temperatures become 135°C (typ) or higher, the thermal shutdown circuit operates and turns a switch OFF. The thermal shutdown circuit, which is aimed at isolating the LSI from thermal runaway as much as possible, is not aimed at the protection or guarantee of the LSI. Therefore, do not continuously use the LSI with this circuit operating or use the LSI assuming its operation.
- (13) Thermal design
Perform thermal design in which there are adequate margins by taking into account the power dissipation (Pd) in actual states of use.

●Ordering part number

B	D	6	5	1	2	F	-	E	2
Part No.		Part No.				Package		Packaging and forming specification	
		6512 6513 6516 6517 2042A 2052A				F: SOP8		E2: Embossed tape and reel (SOP8,SOP-J8)	
						FJ:SOP-J8			

SOP8

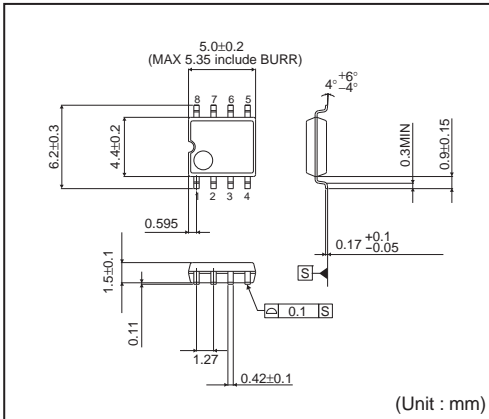

<Tape and Reel information>

Tape	Embossed carrier tape
Quantity	2500pcs
Direction of feed	E2 (The direction is the 1pin of product is at the upper left when you hold reel on the left hand and you pull out the tape on the right hand)

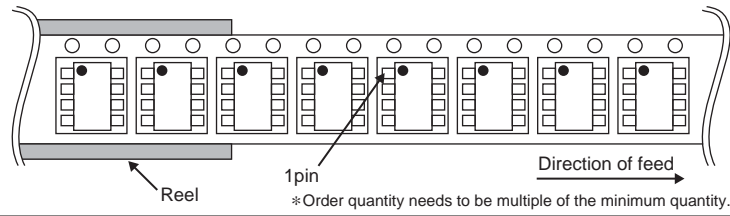

SOP-J8

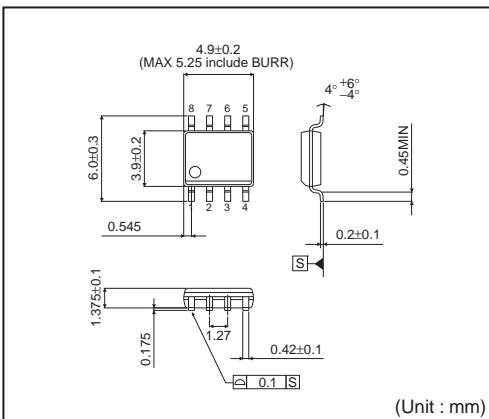

<Tape and Reel information>

Tape	Embossed carrier tape
Quantity	2500pcs
Direction of feed	E2 (The direction is the 1pin of product is at the upper left when you hold reel on the left hand and you pull out the tape on the right hand)

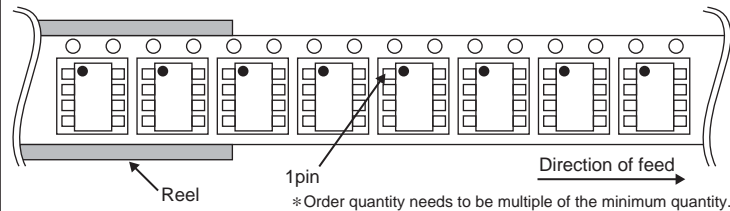

Notes

No copying or reproduction of this document, in part or in whole, is permitted without the consent of ROHM Co.,Ltd.

The content specified herein is subject to change for improvement without notice.

The content specified herein is for the purpose of introducing ROHM's products (hereinafter "Products"). If you wish to use any such Product, please be sure to refer to the specifications, which can be obtained from ROHM upon request.

Examples of application circuits, circuit constants and any other information contained herein illustrate the standard usage and operations of the Products. The peripheral conditions must be taken into account when designing circuits for mass production.

Great care was taken in ensuring the accuracy of the information specified in this document. However, should you incur any damage arising from any inaccuracy or misprint of such information, ROHM shall bear no responsibility for such damage.

The technical information specified herein is intended only to show the typical functions of and examples of application circuits for the Products. ROHM does not grant you, explicitly or implicitly, any license to use or exercise intellectual property or other rights held by ROHM and other parties. ROHM shall bear no responsibility whatsoever for any dispute arising from the use of such technical information.

The Products specified in this document are intended to be used with general-use electronic equipment or devices (such as audio visual equipment, office-automation equipment, communication devices, electronic appliances and amusement devices).

The Products specified in this document are not designed to be radiation tolerant.

While ROHM always makes efforts to enhance the quality and reliability of its Products, a Product may fail or malfunction for a variety of reasons.

Please be sure to implement in your equipment using the Products safety measures to guard against the possibility of physical injury, fire or any other damage caused in the event of the failure of any Product, such as derating, redundancy, fire control and fail-safe designs. ROHM shall bear no responsibility whatsoever for your use of any Product outside of the prescribed scope or not in accordance with the instruction manual.

The Products are not designed or manufactured to be used with any equipment, device or system which requires an extremely high level of reliability the failure or malfunction of which may result in a direct threat to human life or create a risk of human injury (such as a medical instrument, transportation equipment, aerospace machinery, nuclear-reactor controller, fuel-controller or other safety device). ROHM shall bear no responsibility in any way for use of any of the Products for the above special purposes. If a Product is intended to be used for any such special purpose, please contact a ROHM sales representative before purchasing.

If you intend to export or ship overseas any Product or technology specified herein that may be controlled under the Foreign Exchange and the Foreign Trade Law, you will be required to obtain a license or permit under the Law.



Thank you for your accessing to ROHM product informations.
More detail product informations and catalogs are available, please contact us.

ROHM Customer Support System

<http://www.rohm.com/contact/>