

PLEASE CHECK WWW.MOLEX.COM FOR LATEST PART INFORMATION

Part Number: [0014445315](#)
Status: **Active**
Overview: [cgrid_sl_products](#)
Description: 2.54mm (.100") Pitch SL™ Insulation Displacement Connector Assembly, Male, Single Row, Version D, Back Ribs, for Wire Size 22, 0.38µm (15µ") Gold (Au), 15 Circuits

Documents:

[3D Model](#) [Product Specification PS-70400 \(PDF\)](#)
[Drawing \(PDF\)](#) [RoHS Certificate of Compliance \(PDF\)](#)

Agency Certification

CSA LR19980
 UL E29179

General

Product Family Ribbon Cable / Wire Trap Connectors
 Series [70475](#)
 Comments Terminals Preloaded
 Component Type Housing
 Glow-Wire Compliant No
 Overview [cgrid_sl_products](#)
 Product Name SL™

Physical

Circuits (Loaded) 15
 Color - Resin Black
 Durability (mating cycles max) 50
 Entry Angle Vertical
 Flammability 94V-0
 Lock to Mating Part None
 Material - Metal Phosphor Bronze
 Material - Plating Mating Gold
 Material - Plating Termination Tin
 Material - Resin Polyester Alloy
 Number of Rows 1
 PCB Retention None
 Packaging Type Tube
 Pitch - Mating Interface (in) 0.100 In
 Pitch - Mating Interface (mm) 2.54 mm
 Plating min: Mating (µin) 15
 Plating min: Mating (µm) 0.38
 Plating min: Termination (µin) 75
 Plating min: Termination (µm) 1.91
 Polarized to Mating Part No
 Stackable Yes
 Surface Mount Compatible (SMC) N/A
 Temperature Range - Operating -40°C to +105°C
 Termination Interface: Style IDT or Pierce
 Wire Insulation Diameter 1.35mm (.053") max.
 Wire Size AWG 22
 Wire/Cable Type Discrete Wire, Ribbon Cable

Electrical

Current - Maximum per Contact 3A
 Voltage - Maximum 250V

Material Info

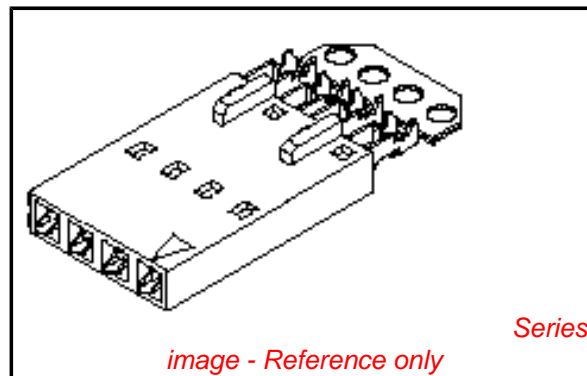

EU RoHS
ELV and RoHS
Compliant
REACH SVHC
Not Reviewed
Halogen-Free
Status
Not Reviewed

China RoHS



Need more information on product environmental compliance?

Email productcompliance@molex.com
 For a multiple part number RoHS Certificate of Compliance, [click here](#)

Please visit the [Contact Us](#) section for any non-product compliance questions.

Search Parts in this Series

[70475Series](#)

Mates With

[70004](#) Interim Clip (Single Row), [70013](#) Interim Clip (Dual Row)

Use With

[7307](#) Tinned 28AWG, [7767](#) Topcoat 28AWG, [24241](#) Tinned 26AWG, [8996](#) Topcoat 26AWG, [24226](#) Tinned 24AWG, [8997](#) Topcoat 24AWG, [24369](#) High Flex 26AWG, [24389](#) High Flex 24AWG

Old Part Number

70475-2359

Reference - Drawing Numbers

Product Specification

PS-70400

This document was generated on 05/20/2010

PLEASE CHECK WWW.MOLEX.COM FOR LATEST PART INFORMATION

OPTION D

NOTES:

- 1) TO BE USED WITH (22) AWG. STRANDED WIRE WITH (1.35)/.053 DIA. MAX. INSULATION.
- 2) SEE CHART FOR CIRCUIT SIZES.
- 3) STANDARD PACKAGING PER PK-70873-0001. OPTIONAL PACKAGING MAY BE AVAILABLE, REQUEST DWG. PK-70475.
- 4) PARTS STACKABLE END TO END ON (2.54)/.100 CENTERS.
- 5) REFER TO PRODUCT SPECIFICATION: PS-70475.
- 6) SEE DWG. SDA-70475-***** (SHT.3) FOR OPTIONAL HOUSING DETAILS.
- 7) 4 CIRCUIT SHOWN. 3 - 25 CKT'S. HAVE (2) RIBS.
- 8) TO MATE WITH MOLEX PART NO'S.: 70018-****, 70022-****, 70104-****.
- 9) 2 CIRCUIT ASSEMBLIES SUPPLIED AS GROUPED PAIRS.

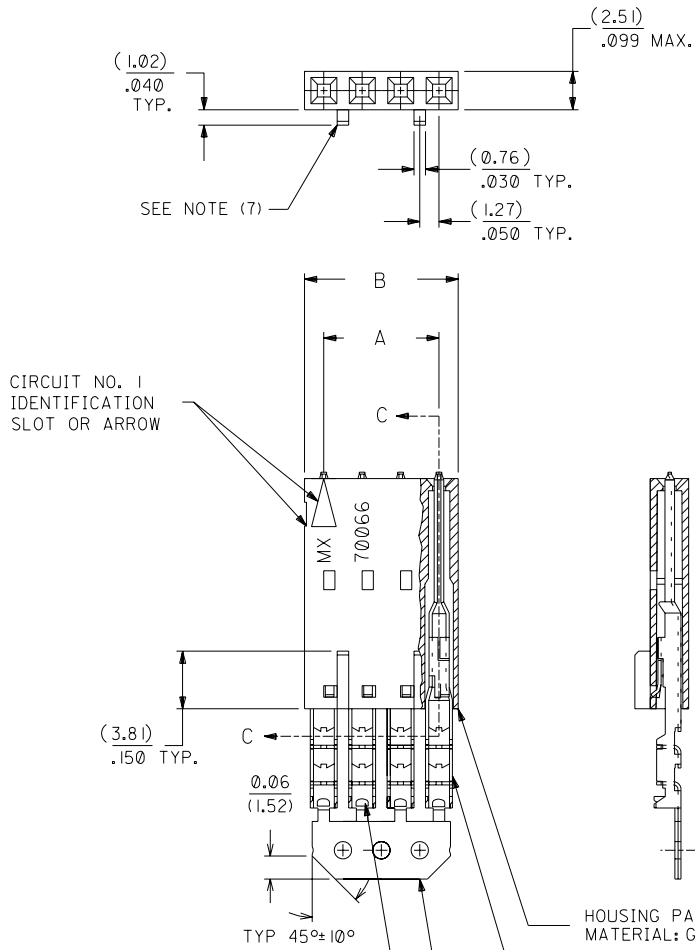

SECTION C-C

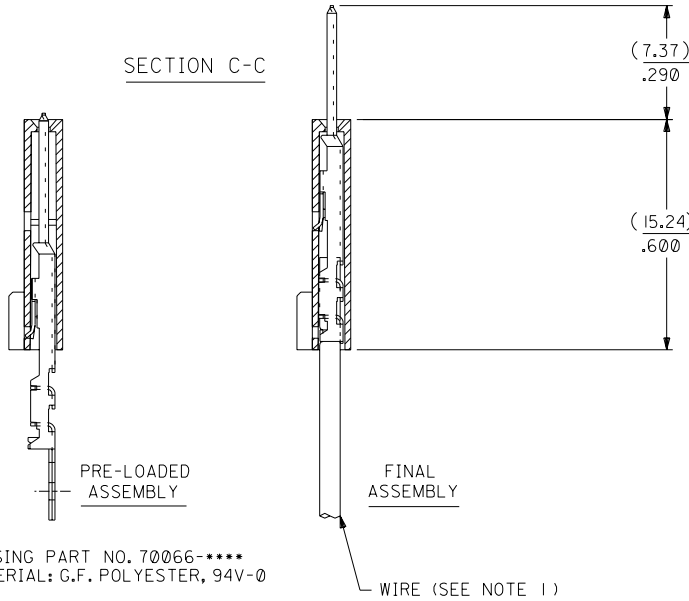

I.D. SLOT CODE TO WIRE GAUGE CHART	
I.D. SLOT CODE	WIRE GAUGE
D	22 AWG.

PLATING CODE (STRIPE ON CARRIER STRIP)	
PLATING	COLOR
15 GOLD	YELLOW

15 GOLD - .000015 MINIMUM GOLD IN SELECT AREA WITH .000075 MINIMUM TIN IN SELECT AREA OVER .000050 MINIMUM NICKEL OVER-ALL.

*THE PRIMARY SHIPPING CARTON WILL BE LABELED "COMPLIANT TO RoHS DIRECTIVE 2002/95/EC AND ELV ANNEX II OF DIRECTIVE 2000/53/EC". CARTONS WITHOUT THIS LABEL MAY CONTAIN PRODUCT WITH LEAD.

CKT. SIZE	A	B	EDP. NO.	ENG. NO.
2	(2.54) .100	(5.05) .199	14-44-5302	A-70475-2346
3	(5.08) .200	(7.59) .299	14-44-5303	A-70475-2347
4	(7.62) .300	(10.13) .399	14-44-5304	A-70475-2348
5	(10.16) .400	(12.67) .499	14-44-5305	A-70475-2349
6	(12.70) .500	(15.21) .599	14-44-5306	A-70475-2350
7	(15.24) .600	(17.75) .699	14-44-5307	A-70475-2351
8	(17.78) .700	(20.29) .799	14-44-5308	A-70475-2352
9	(20.32) .800	(22.83) .899	14-44-5309	A-70475-2353
10	(22.86) .900	(25.37) .999	14-44-5310	A-70475-2354
11	(25.54) 1.000	(27.91) 1.099	14-44-5311	A-70475-2355
12	(27.94) 1.100	(30.45) 1.199	14-44-5312	A-70475-2356
13	(30.48) 1.200	(32.99) 1.299	14-44-5313	A-70475-2357
14	(33.02) 1.300	(35.53) 1.399	14-44-5314	A-70475-2358
15	(35.56) 1.400	(38.07) 1.499	14-44-5315	A-70475-2359
16	(38.01) 1.500	(40.61) 1.599	14-44-5316	A-70475-2360
17	(40.64) 1.600	(43.15) 1.699	14-44-5317	A-70475-2361
18	(43.18) 1.700	(45.69) 1.799	14-44-5318	A-70475-2362
19	(45.72) 1.800	(48.23) 1.899	14-44-5319	A-70475-2363
20	(48.26) 1.900	(50.77) 1.999	14-44-5320	A-70475-2364
21	(50.80) 2.000	(53.31) 2.099	14-44-5321	A-70475-2365
22	(53.34) 2.100	(55.85) 2.199	14-44-5322	A-70475-2366
23	(55.88) 2.200	(58.39) 2.299	14-44-5323	A-70475-2367
24	(58.42) 2.300	(60.93) 2.399	14-44-5324	A-70475-2368
25	(60.96) 2.400	(63.47) 2.499	14-44-5325	A-70475-2369