

U8668-D

FCC Information and Copyright

www.DataSheet4U.com

This equipment has been tested and found to comply with the limits of a Class B digital device, pursuant to Part 15 of the FCC Rules. These limits are designed to provide reasonable protection against harmful interference in a residential installation. This equipment generates, uses and can radiate radio frequency energy and, if not installed and used in accordance with the instructions, may cause harmful interference to radio communications. There is no guarantee that interference will not occur in a particular installation.

The vendor makes no representations or warranties with respect to the contents here of and specially disclaims any implied warranties of merchantability or fitness for any purpose. Further the vendor reserves the right to revise this publication and to make changes to the contents here of without obligation to notify any party beforehand.

Duplication of this publication, in part or in whole, is not allowed without first obtaining the vendor's approval in writing.

The content of this user's manual is subject to be changed without notice and we will not be responsible for any mistakes found in this user's manual. All the brand and product names are trademarks of their respective companies.

U8668-D

ENGLISH	1
U8668-D Features	1
Package contents.....	2
Layout of U8668-D.....	3
Component Index	4
CPU Installation.....	5
DDR DIMM Modules: DDR1-2	6
Jumpers, Headers, Connectors & Slots	7
ESPAÑOL	13
Características del U8668-D	13
Contenido del Paquete	14
Disposición del U8668-D	15
Índice de los Componentes.....	16
Instalación de la CPU.....	17
Módulos DDR DIMM: DDR1-2	18
Puentes, Cabezales, Conectores & Ranuras	19
FRANÇAIS	25
Caractéristiques de U8668-D.....	25
Contenu de l'Emballage.....	26
Dessin d'U8668-D.....	27
WARPSPEEDER	28
Introduction	29
System Requirement.....	29
Installation	29
Usage	30
TROUBLE SHOOTING	38
SOLUCIÓN DE PROBLEMAS	39

Motherboard Description

English

U8668-D Features

CPU

- Provides Socket-478.
- Supports the Intel Pentium 4 processor up to 3.06GHz.
- Running at 400/533MHz Front Side Bus.
- Supports Hyper-Treading.

Chipset

- North Bridge: P4M266A
- South Bridge: VT8235.

Main Memory

- Supports up to 2 DDR devices.
- Supports 200/266MHz DDR devices.
- The largest memory capacity is 2GB.

Super I/O

- Chipset: ITE IT8705F.

Slots

- Two 32-bit PCI bus master slots.
- One AMR slot.
- One AGP slot.

On Board IDE

- Supports four IDE disk drives.
- Supports PIO Mode 4, Master Mode and Ultra DMA 33/66/100/133 Bus Master Mode.

On Board VGA

- Integrated Savage4 2D/3D Graphics Controller and Video Accelerator.

LAN

- VT6103
- Dual Speed: 10/100Mbps.
- Full/Half Duplex.
- Auto Negotiation : 10/100 Mbps, Full/Half Duplex.

On Board AC'97 Sound Codec

- Compliant with AC'97 specification.

On Board Peripherals

Motherboard Description

- Supports 360K, 720K, 1.2MB, 1.44MB and 2.88MB floppy disk drivers.
- Supports 1 serial port.
- Supports 1 multi-mode parallel port. (SPP/EPP/ECP mode)
- Supports PS/2 mouse and PS/2 keyboard.
- Supports 2 back USB2.0 ports and 4 front USB2.0 ports.

BIOS

- AWARD legal Bios.
- Supports APM1.2.
- Supports ACPI.
- Supports USB Function.

Operating System

- Offers the highest performance for MS-DOS, Windows 2000, Windows Me, Windows XP, SCO UNIX etc.

Dimensions

- Flex Form Factor: 19.5cm X22.8cm. (W X L)

Package contents

- HDD Cable X1
- FDD Cable X1
- Flash Memory Writer for BIOS Update X1
- USB Cable X1 (Optional)
- Rear I/O Panel for Flex Case X1 (Optional)
- Fully Setup Driver CD X1

Motherboard Description

Layout of U8668-D

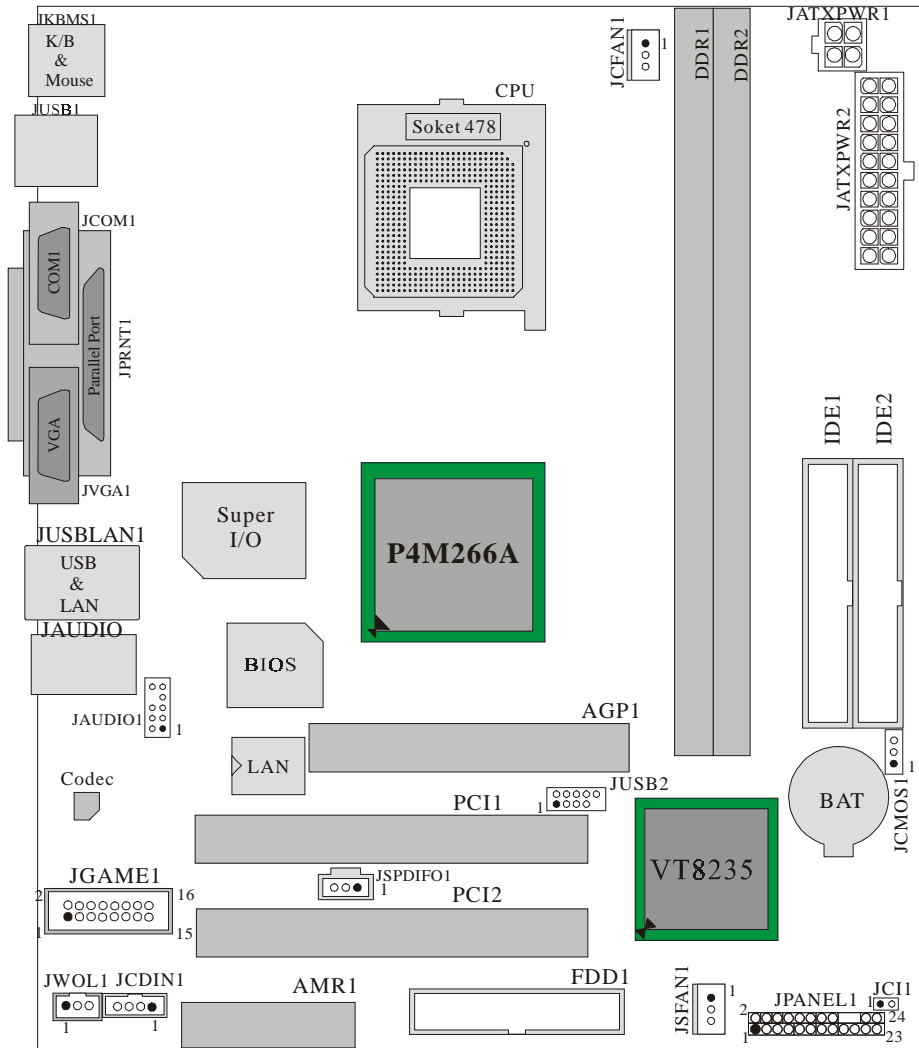

Motherboard Description

Component Index

www.DataSheet4U.com

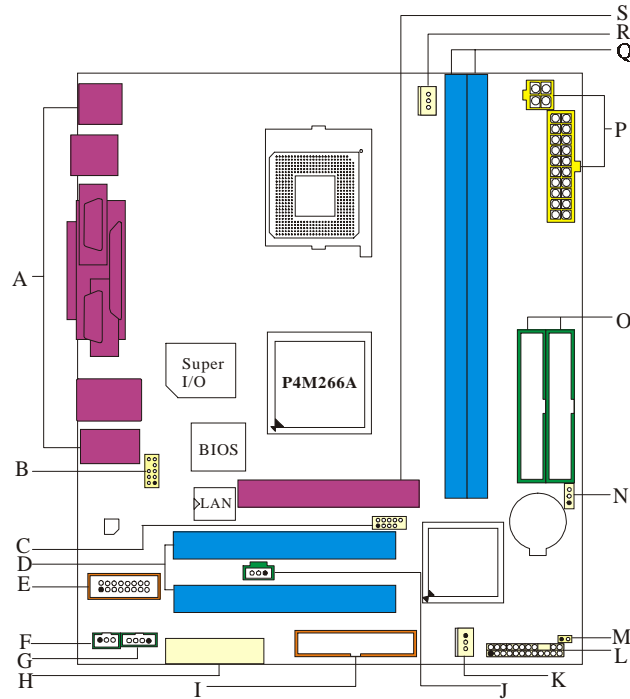

- | | |
|---------------------------------------|-------------------------------------|
| A. Back Panel Connectors | K. System Fan Connector (JSFAN1) |
| B. Front Audio Header (JAUDIO1) | L. Front Panel Connectors (JPANEL1) |
| C. Front USB Header (JUSB2) | M. Case Open Connector (JCI1) |
| D. PCI Slots (PCI1-2) | N. Clear CMOS (JCMOS1) |
| E. GAME Header (JGAME1):optional | O. IDE Connectors (IDE1-2) |
| F. Wake OnLAN Header (JWOL1) | P. ATX Power Connector (JATXPWR1-2) |
| G. CD-ROM Audio-In Header (JCDIN1) | Q. DDRs (DDR1-2) |
| H. AMR Slot (AMR1) | R. CPU Fan Connector (JCFAN1) |
| I. Floppy Disk Connector (FDD1) | S. AGP Slot (AGP1) |
| J. Digital Audio Connector (JSPDIFO1) | |

Motherboard Description

CPU Installation

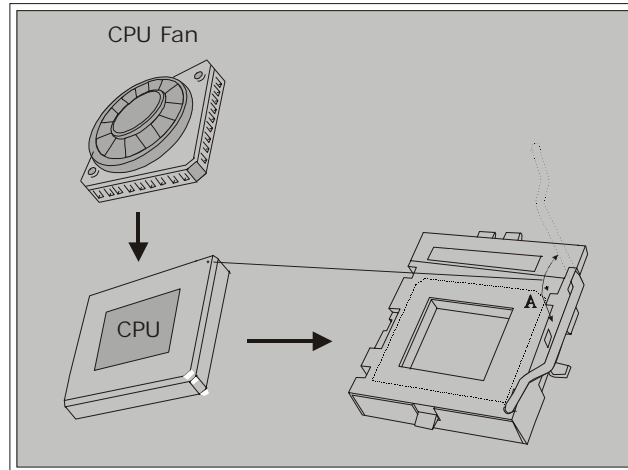

1. Pull the lever sideways away from the socket then raise the lever up to a 90-degree angle.
2. Locate Pin A in the socket and look for the white dot or cut edge in the CPU. Match Pin A with the white dot/cut edge then insert the CPU.
3. Press the lever down. Then Put the fan on the CPU and buckle it and put the fan's power port into the JCFAN1, then to complete the installation.

CPU/ System Fan Headers: JCFAN1/ JSFAN1

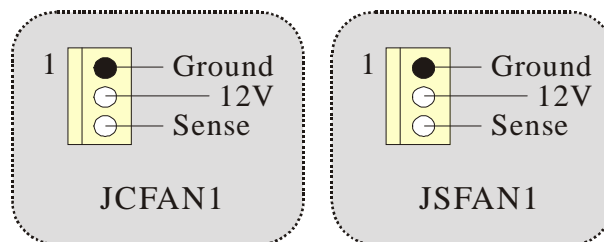

Motherboard Description

DDR DIMM Modules: DDR1-2

DRAM Access Time: 2.5V Unbuffered/ Registered DDR 200 MHz (PC1600)/
DDR 266 MHz (PC2100) Type required.

DRAM Type: 64MB/ 128MB/ 256MB/ 512MB/ 1GB DIMM Module.(184 pin)

DIMM Socket Location	DDR Module	Total Memory Size (MB)
DDR 1	64MB/128MB/256MB/512MB/1GB *1	Max is 2GB
DDR 2	64MB/128MB/256MB/512MB/1GB *1	

- The list shown above for DRAM configuration is only for reference.

How to install DDR DIMM Module

1. The DDR DIMM socket has a “ Plastic Safety Tab”, and the DDR DIMM memory module has an Asymmetrical notch”, so the DDR DIMM memory module can only fit into the slot in one direction.

2. Push the tabs out. Insert the DDR DIMM memory modules into the socket at a 90-degree angle, then push down vertically so that it will fit into the place.

3. The Mounting Holes and plastic tabs should fit over the edge and hold the DDR DIMM memory modules in place.

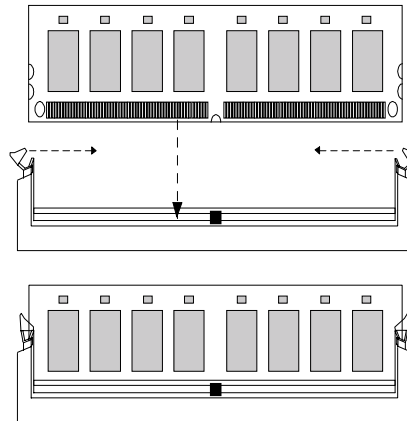

Motherboard Description

Jumpers, Headers, Connectors & Slots

Hard Disk Connectors: IDE1/ IDE2

The motherboard has a 32-bit Enhanced PCI IDE Controller that provides PIO Mode 0-4, Bus Master, and Ultra DMA 33/ 66/ 100/ 133 functionality. It has two HDD connectors IDE1 (primary) and IDE2 (secondary).

The IDE connectors can connect a master and a slave drive, so you can connect up to four hard disk drives. The first hard drive should always be connected to IDE1.

Floppy Disk Connector: FDD1

The motherboard provides a standard floppy disk connector that supports 360K, 720K, 1.2M, 1.44M and 2.88M floppy disk types. This connector supports the provided floppy drive ribbon cables.

Audio Modem Riser Slot: AMR1

(Only support slave card)

The AMR specification is an open Industry Standard Architecture and that defines a hardware scalable riser card interface, which supports audio and modem only.

Peripheral Component Interconnect Slots: PCI1-2

This motherboard is equipped with 2 standard PCI slots. PCI stands for Peripheral Component Interconnect, and it is a bus standard for expansion cards. This PCI slot is designated as 32 bits.

Accelerated Graphics Port Slot: AGP1

Your monitor will attach directly to that video card. This motherboard supports video cards for PCI slots, but it is also equipped with an Accelerated Graphics Port (AGP). An AGP card will take advantage of AGP technology for improved video efficiency and performance, especially with 3D graphics.

Front USB Header: JUSB2

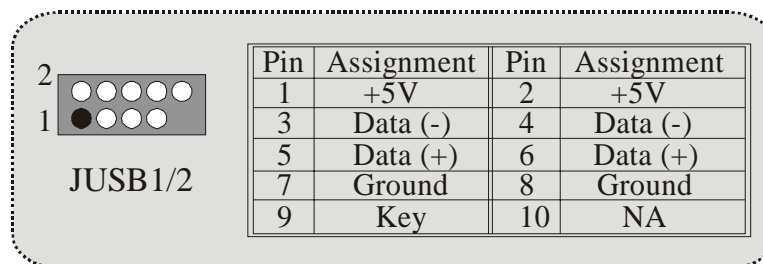

Motherboard Description

Power Connectors: JATXPWR1/ JATXPWR2

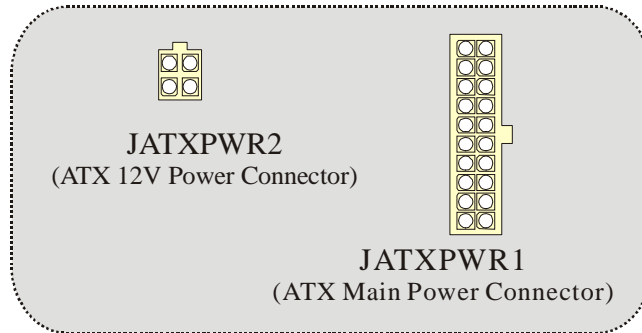

JATXPWR1

PIN	Assignment	PIN	Assignment
1	+3.3V	11	+3.3V
2	+3.3V	12	-12V
3	Ground	13	Ground
4	+5V	14	PS_ON
5	Ground	15	Ground
6	+5V	16	Ground
7	Ground	17	Ground
8	PW_OK	18	-5V
9	+5V_SB	19	+5V
10	+12V	20	+5V

JATXPWR2

PIN	Assignment	PIN	Assignment
1	12V	3	Ground
2	12V	4	Ground

Motherboard Description

Front Panel Connector: JPANEL1

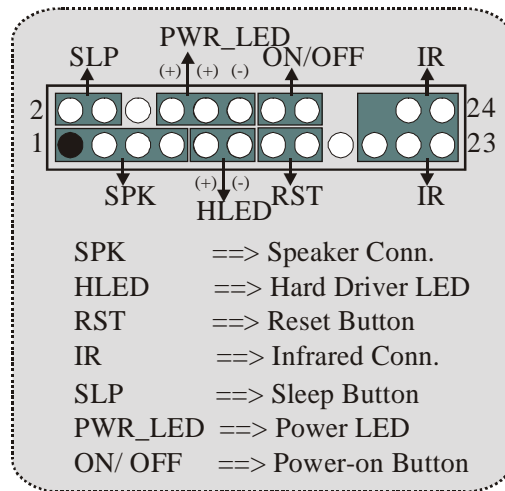

Clear CMOS Jumper: JCMOS

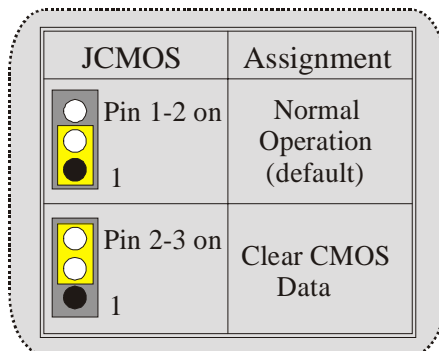

※ Clear CMOS Procedures:

1. Remove AC power line.
2. Make JCMOS1 (2-3) closed.
3. Wait for five seconds.
4. Make JCMOS1 (1-2) closed.
5. Let AC power on.
6. Reset your desired password or clear the CMOS data.

Motherboard Description

Audio Subsystem: JAUDIO1/ JCDIN1

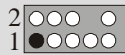

JAUDIO1
(Front Audio Header)

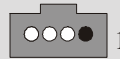

JCDIN1
(CD-ROM Audio-In Header)

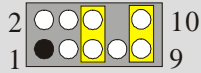

JF_AUDIO1

Pin	Assignment	Pin	Assignment
1	Mic In	2	Ground
3	Mic Power	4	Audio Power
5	RT Line Out	6	RT Line Out
7	Reserved	8	Key
9	LFT Line Out	10	LFT Line Out

- JF_AUDIO1 only support 2CH.

Front Panel Audio Connector/ Jumper Block

Jumper Setting	Configuration
<p>Pin 5 and 6 Pin 9 and 10</p>	Audio line out signals are routed to the back panel audio line out connector.
<p>No jumpers installed</p>	Audio line out and mic in signals are available for front panel audio connectors.

Motherboard Description

Game Header: JGAME1

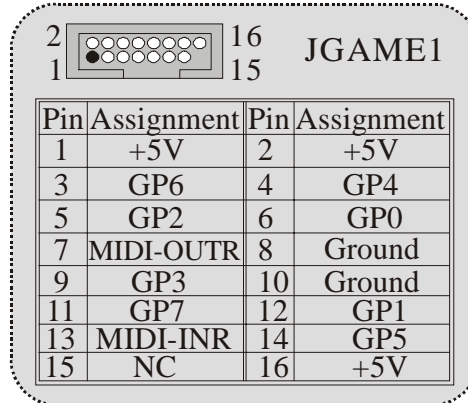

Digital Audio Connector: JSPDIF01

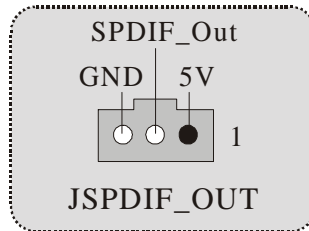

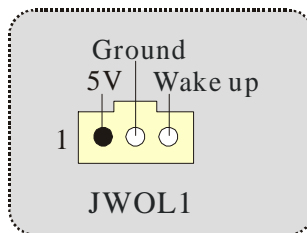

Wake OnLAN Header :JWOL1



Motherboard Description

Case Open Connector: JCI1

JCI1	Assignment
 1 No jumper installed	Normal Operation (default)
 1 Pin 1-2 on	Case Open

Back Panel Connectors

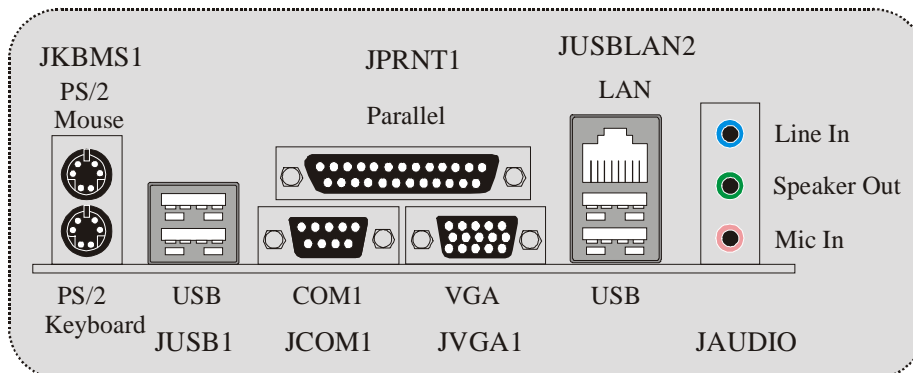

Motherboard Description

Español

Características del U8668-D

CPU

- Proporciona Socket-478.
- Soporta procesador Intel Pentium 4 de hasta 3.06GHz.
- Corre a 400/ 533MHz Front Side Bus.
- Soporta Hyper-Threading.

Chipset

- North Bridge: P4M266A
- South Bridge: VT8235.

Memoria Principal

- Soporta hasta 2 dispositivos DDR.
- Soporta dispositivos DDR de 200/ 266MHz.
- Capacidad máxima de memoria 2GB.

Super I/O

- Chipset: ITE IT8705F.

Ranuras

- Dos ranuras de 32-bit PCI bus master.
- Una ranura AMR.
- Una ranura AGP.

IDE Onboard

- Soporta cuatro discos IDE.
- Soporta Modos PIO 4, Modo Master y Modo Ultra DMA 33/66/100/133 Bus Master.

VGA Onboard

- Integrated Savage4 2D/3D Controlador Gráfico y Acelerador de Video.

LAN

- VT6103
- Dual Speed: 10/100Mbps.
- Full/Half Duplex.
- Auto Negociación : 10/100 Mbps, Full/Half Duplex.

AC'97 Sound Codec Onboard

- Constituye con la especificación del AC'97.

Periféricos Onboard

- Soporta disquette de 360K, 720K, 1.2MB, 1.44MB y 2.88MB.

Motherboard Description

- Soporta 1 puerto serie.
- Soporta 1 puerto paralelo multi-mode. (modo SPP/EPP/ECP)
- Soporta ratón PS/2 y teclado PS/2.
- Soporta 2 puertos USB2.0 traseros y 4 puertos USB2.0 frontales.

BIOS

- AWARD legal Bios.
- Soporta APM1.2.
- Soporta ACPI.
- Soporta función USB.

Sistemas Operativos

- Ofrece el más alto funcionamiento para MS-DOS, Windows 2000, Windows Me, Windows XP, SCO UNIX etc.

Dimensiones

- Factor de Forma Flex: 19.5cm X22.8cm. (W X L)

Contenido del Paquete

- Cable HDD X1
- Cable FDD X1
- Flash Memory Writer para actualización del BIOS X1
- Cable USB X1 (Opcional)
- Panel Trasero I/O para carcasa Flex X1 (Opcional)
- Configuración completa del Driver CD X1

Motherboard Description

Disposición del U8668-D

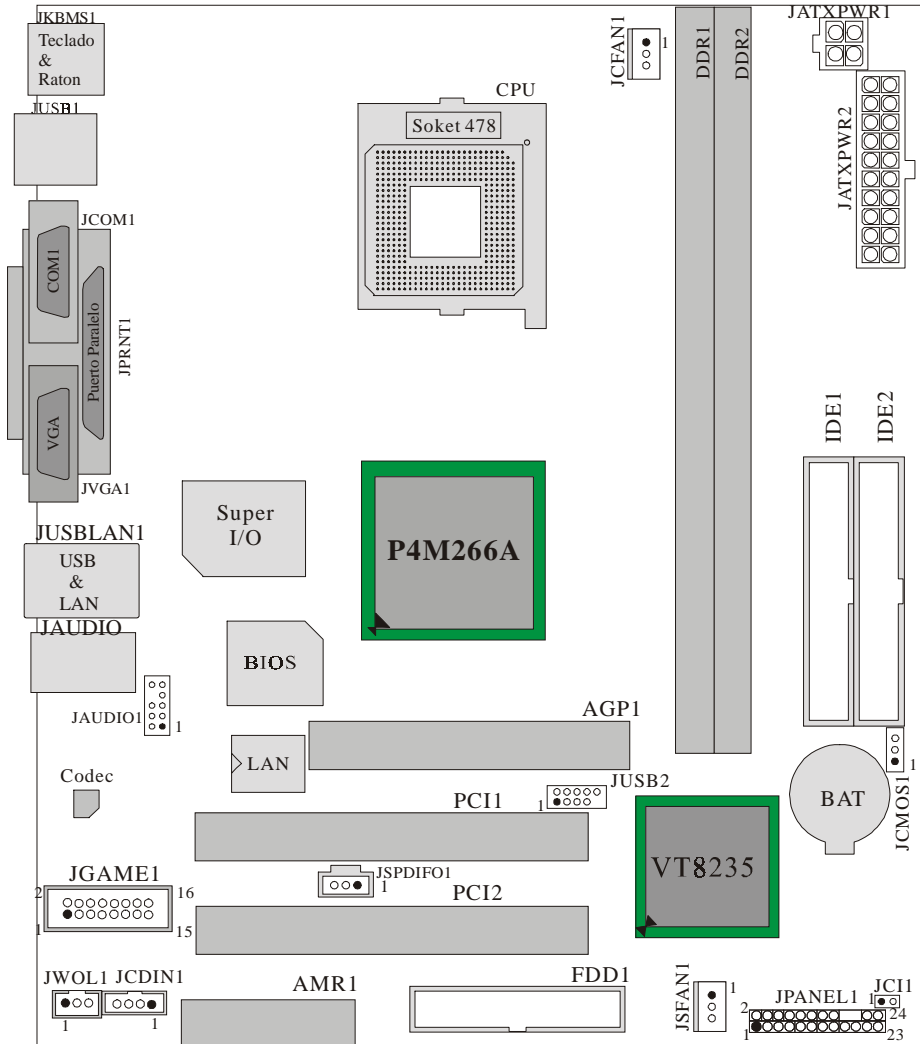

Motherboard Description

Indice de los Componentes

www.DataSheet4U.com

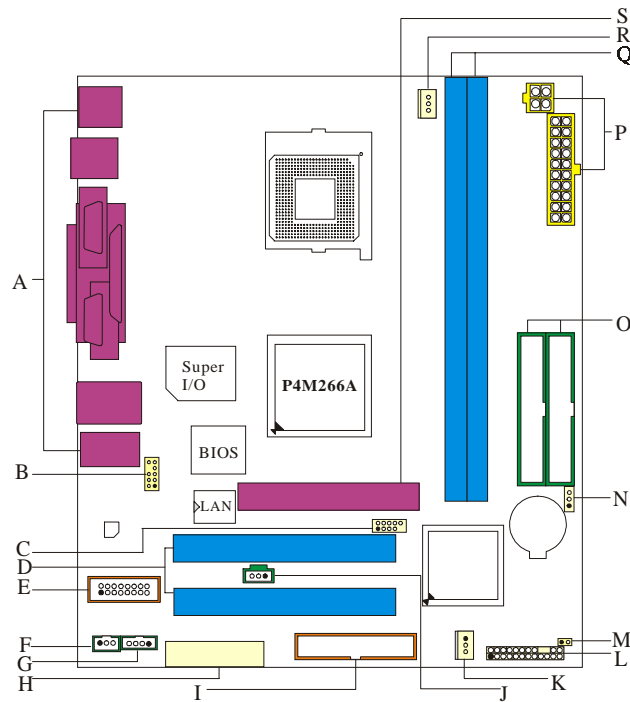

- | | |
|----------------------------------------------------|-------------------------------------------------|
| A. Conectores del Panel Trasero | K. Conector del Sistema de Ventilación (JSFAN1) |
| B. Cabezal Frontal de Audio (JAUDIO1) | L. Conectores del Panel Frontal (JPANEL1) |
| C. Cabezal Frontal USB (JUSB2) | M. Conector de la Carcasa Abierta (JCI1) |
| D. Ranuras PCI (PCI1-2) | N. Borrar CMOS (JCMOS1) |
| E. Cabezal de Juego (JGAME1):opcional | O. Conectores IDE (IDE1-2) |
| F. Cabezal Wake On LAN (JWOL1) | P. Conector de Corriente ATX (JATXPWR1-2) |
| G. Cabezal de Entrada de Audio del CD-ROM (JCDIN1) | Q. DDRs (DDR1-2) |
| H. Ranura AMR (AMR1) | R. Conector de Ventilación del CPU (JCFAN1) |
| I. Conector para disquetera (FDD1) | S. Ranura AGP (AGP1) |
| J. Conector de Audio Digital (JSPDIF01) | |

Motherboard Description

Instalación de la CPU

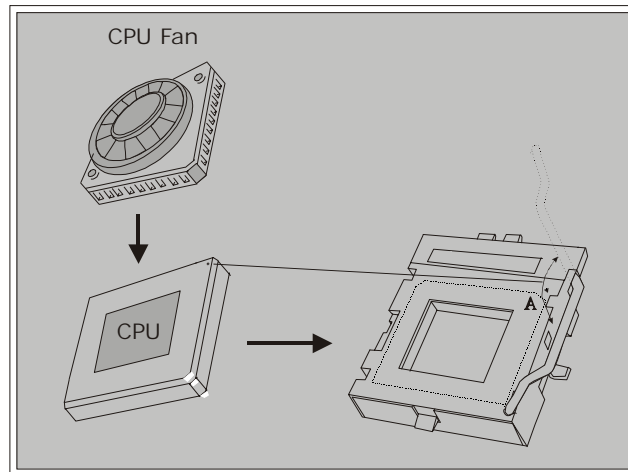

1. Tire de la palanca del lado del zócalo, luego levante la palanca hasta un ángulo de 90 grados.
2. Sitúe el contacto A del zócalo y busque el punto blanco o corte el borde en la CPU. Empareje el contacto A con el punto blanco/ corte del borde, luego inserte la CPU.
3. Presione la palanca para abajo. Ponga el ventilador en la CPU y abróchelo. Luego ponga el puerto de corriente del ventilador en el JCFAN1. Y ya habrá completado su instalación.

CPU/ Cabezales del Sistema de Ventilación: JCFAN1/ JSFAN1

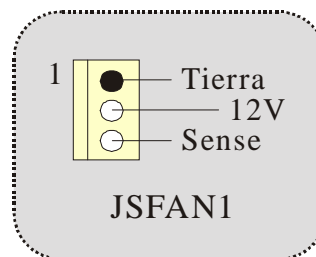
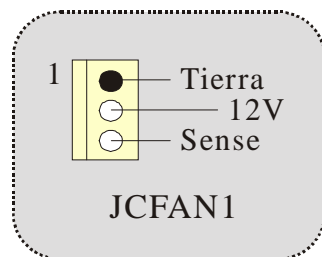

Motherboard Description

Módulos DDR DIMM: DDR1-2

DRAM Tiempo de Acceso: 2.5V Unbuffered/ Registered DDR 200 MHz (PC1600)/ DDR 266 MHz (PC2100) Tipo requerido.

DRAM Tipo: 64MB/ 128MB/ 256MB/ 512MB/ 1GB Módulo DIMM.(contactos 184)

Localización del Socket DIMM	Módulo DDR	Total del Tamaño de Memoria (MB)
DDR 1	64MB/128MB/256MB/512MB/1GB *1	Máxima 2GB
DDR 2	64MB/128MB/256MB/512MB/1GB *1	

- La lista de arriba para la configuración DRAM es solamente para referencia.

Cómo instalar un Módulo DDR DIMM

1. El zócalo DIMM tiene una lengüeta plástica de seguridad y el módulo de memoria DIMM tiene una muesca asimétrica, así el módulo de memoria DIMM puede caer solamente en la ranura de una sola dirección.

2. Tire la lengüeta hacia afuera. Inserte los módulos de memoria DIMM en el zócalo a los 90 grados, luego empuje hacia abajo de modo que encaje en el lugar.

3. Los agujeros de montaje y las lengüetas plásticas deben caer por sobre el borde y sostenga los módulos de memoria DIMM en el lugar.

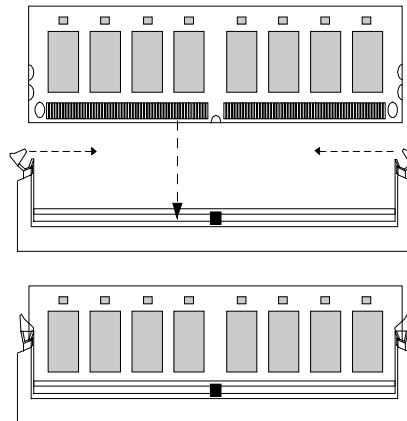

Motherboard Description

Puentes, Cabezales, Conectores & Ranuras

Conectores del Disco Duro: IDE1/ IDE2

La placa madre tiene un controlador de 32-bit PCI IDE que proporciona Modo PIO 0~4, Bus Master, y funcionalidad Ultra DMA 33/ 66/ 100/ 133. Tiene dos conectores HDD IDE1 (primario) y IDE2 (secundario).

El conector IDE puede conectar a un master y un drive esclavo, así puede conectar hasta cuatro discos rígidos. El primer disco duro debe estar siempre conectado al IDE1.

Conector para Disquete: FDD1

La placa madre proporciona un conector estándar del disquete (FDC) que soporta 360K, 720K, 1.2M, 1.44M y 2.88M tipos de disquete. Éste conector utiliza los cables de cinta proporcionados por el disquete.

Ranura Audio y Módem Riser: AMR1

(Solamente soporta tarjeta esclava)

La especificación AMR es una Arquitectura de Industria Estándar y define una tarjeta elevadora de interface del hardware en el que soporta solamente audio y módem.

Ranura de Interconexión del Componente Periférico: PCI1-2

Ésta placa madre está equipada con 2 ranuras estándar PCI. PCI es la sigla para Interconexión del Componente Periférico, y es un bus estándar para tarjetas de expansión. Ésta ranura PCI está diseñado con 32 bits.

Ranura del Puerto Acelerado para Gráficos: AGP1

Su monitor se fijará directamente a la tarjeta de video. Ésta placa madre soporta tarjetas de video para PCI, pero también está equipada con puerto AGP. La tarjeta AGP tomará ventaja de la tecnología del AGP para el mejoramiento de la eficiencia y funcionamiento del video, especialmente con gráficos 3D.

Cabezal Frontal USB: JUSB2

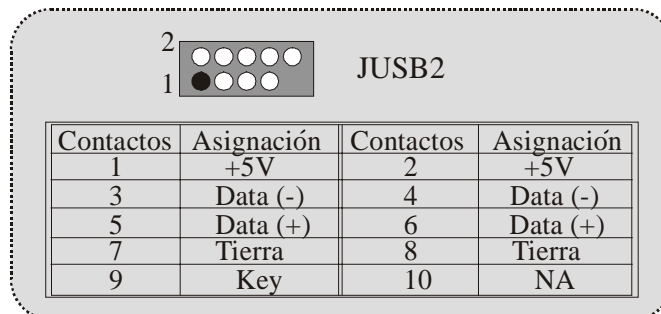

Motherboard Description

Conectores de Corriente: JATXPWR1/ JATXPWR2

www.DataSheet4U.com

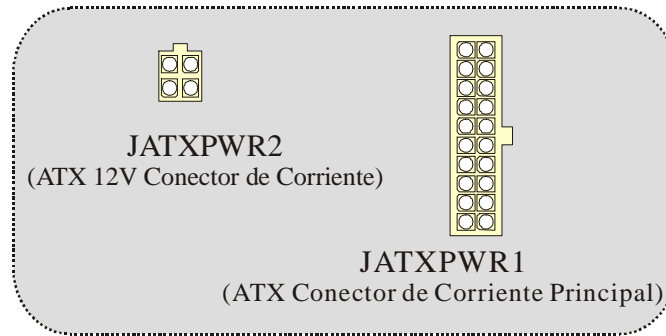

JATXPWR1

Contacto	Asignación	Contacto	Asignación
1	+3.3V	11	+3.3V
2	+3.3V	12	-12V
3	Tierra	13	Tierra
4	+5V	14	PS_ON
5	Tierra	15	Tierra
6	+5V	16	Tierra
7	Tierra	17	Tierra
8	PW_OK	18	-5V
9	+5V_SB	19	+5V
10	+12V	20	+5V

JATXPWR2

Contacto	Asignación	Contacto	Asignación
1	12V	3	Tierra
2	12V	4	Tierra

Motherboard Description

Conector del Panel Frontal: JPANEL1

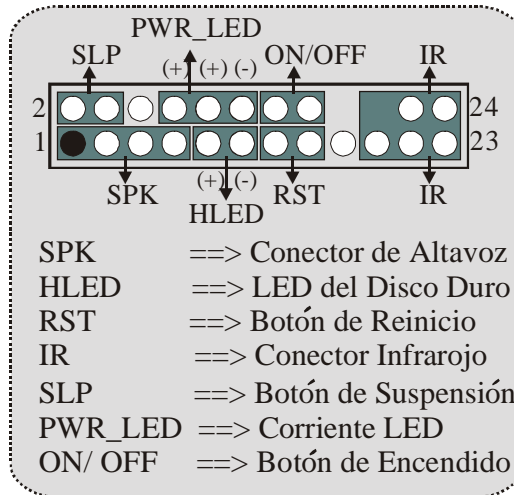

Puente de Borrar CMOS: JCMOS

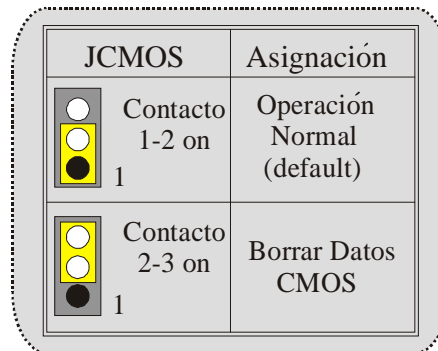

※ Procedimientos para Borrar CMOS:

1. Quite el cable de corriente del AC.
2. Cerrar JCMOS1 contactos 2-3.
3. Esperar cinco segundos.
4. Cerrar JCMOS1 contactos 1-2.
5. Encienda AC.
6. Reconfigure la contraseña deseada o borre datos CMOS.

Motherboard Description

Subsistema de Audio: JAUDIO1/ JCDIN1

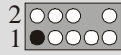

JAUDIO1
(Cabezal Frontal de Audio)

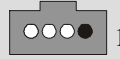

JCDIN1
(Cabezal de Entrada de Audio CD-ROM)

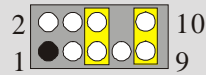

JAUDIO1

Contactos	Asignación	Contactos	Asignación
1	Entrada del MIC	2	Tierra
3	Corriente del MIC	4	Corriente de Audio
5	RT Salida de Línea	6	RT Salida de Línea
7	Reservado	8	Key
9	LFT Salida de Línea	10	LFT Salida de Línea

- JAUDIO1 solamente soporta 2CH.

Conector del Panel Frontal de Audio/ Jumper Block

Jumper Setting	Configuración
<p style="text-align: center;">Contacto 5 & 6 Contacto 9 & 10</p>	<p>La señal de salida de línea del Audio encamina al conector de la salida de línea del Audio ubicado en el panel trasero.</p>
<p style="text-align: center;">No jumpers installed</p>	<p>La señal de salida de línea del Audio y la señal del entrada del mic estan disponibles desde el conector de Audio del panel frontal.</p>

Motherboard Description

Cabezal de Juego: JGAME1

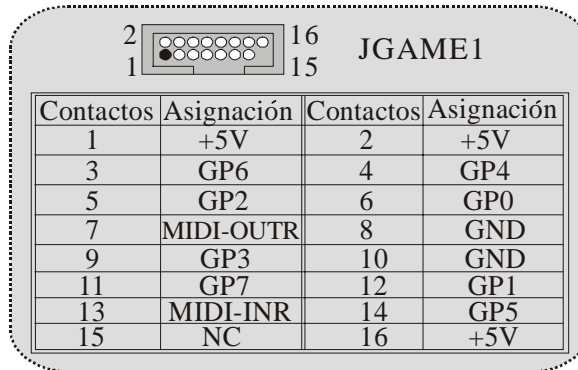

Conector Digital de Audio: JSPDIF01

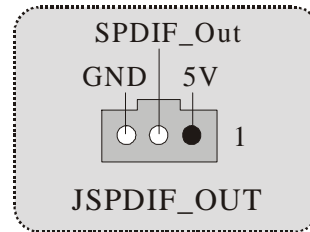

Cabezal Wake On LAN: JWOL1

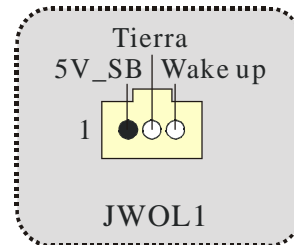

Conector de la Carcasa Abierta: JCI1

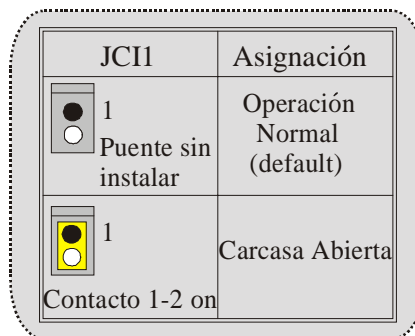

Motherboard Description

Conectores del Panel Trasero

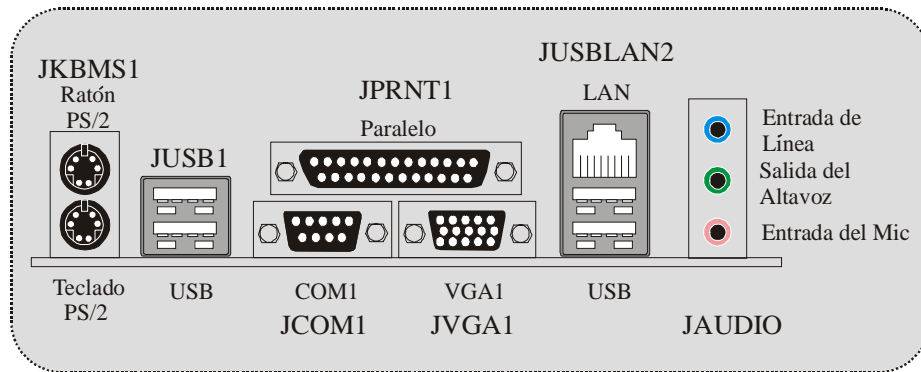

Motherboard Description

Français

Caractéristiques de U8668-D

CPU

- Offre les Socket-478.
- Supporte le processeur Intel Pentium 4 jusqu'à 3.06GHz.
- Fonctionnant en Bus Frontal de 400/ 533MHz.
- Supporte Hyper-Threading.

Chipset

- North Bridge: P4M266A
- South Bridge: VT8235.

Mémoire Principale

- Supporte jusqu'à 2 matériels DDR.
- Supporte des matériels DDR en 200/266MHz.
- La plus grande capacité mémoire est 2Go.

Super E/S

- Chipset: ITE IT8705F.

Slots

- Deux slots de maîtrise de bus PCI 32 bits.
- Un slot AMR.
- Un slot AGP

IDE Interne

- Supporte quatre disques durs IDE.
- Supporte PIO Mode 4, le Mode Maître et le Mode de Maîtrise de Bus Ultra DMA 33/66/100/133.

VGA Interne

- Contrôleur Graphique 2D/3D intégré Savage4 et Accélérateur Vidéo.

LAN

- VT6103
- Double Vitesse: 10/100Mbps.
- Full/Half Duplex.
- Négociation automatique : 10/100 Mbps, Full/Half Duplex.

Codec Son AC'97 Interne

- Conforme aux spécifications du codec AC'97

Motherboard Description

Périphériques Internes

- Supporte les lecteurs de disquettes 360K, 720K, 1.2Mo, 1.44Mo et 2.88Mo.
- Supporte 1 port série.
- Supporte 1 port parallèle multi-mode. (mode SPP/EPP/ECP)
- Supporte souris PS/2 et clavier PS/2.
- Supporte 2 ports USB2.0 arrières et 4 ports USB2.0 avants.

BIOS

- AWARD legal Bios.
- Supporte APM1.2.
- Supporte ACPI
- Supporte la Fonction USB.

Système d'Exploitation

- Offre les meilleures performances pour MS-DOS, Windows 2000, Windows Me, Windows XP, SCO UNIX etc.

Dimensions

- Facteur de Forme Flex: 19.5cm X 22.8cm. (I X L)

Contenu de l'Emballage

- Câble de Disque Dur X1
- Câble de Lecteur de Disquette X1
- Enregistreur de Mémoire Flash pour mise à niveau du BIOS X1
- Câble USB X1 (Optionnel)
- Panneau d'E/S Arrière pour Boîtier Flex X 1 (Optionnel)
- CD de Pilote Complet X 1

Motherboard Description

Dessin d'U8668-D

www.DataSheet4U.com

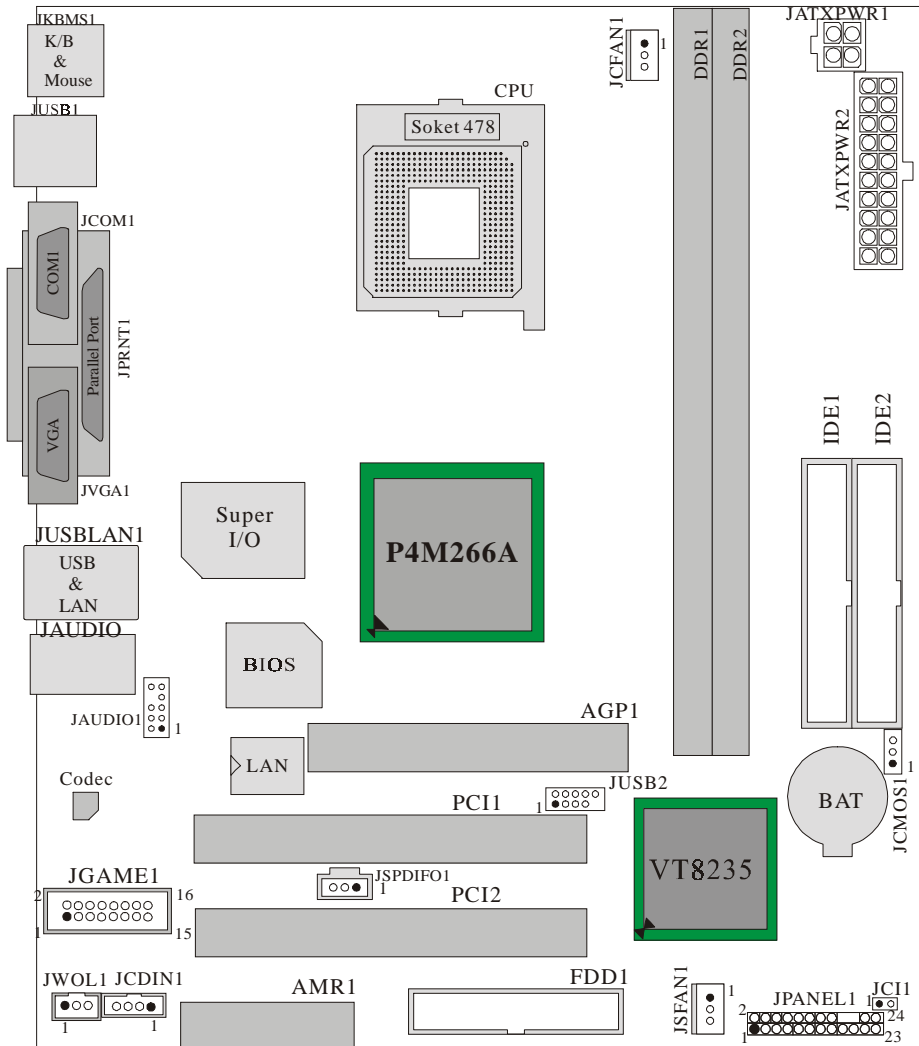

Motherboard Description

www.DataSheet4U.com

WarpSpeeder



Motherboard Description

Introduction

[WarpSpeeder™], a new powerful control utility, features three user-friendly functions including Overclock Manager, Overvoltage Manager, and Hardware Monitor.

With the Overclock Manager, users can easily adjust the frequency they prefer or they can get the best CPU performance with just one click. The Overvoltage Manager, on the other hand, helps to power up CPU core voltage and Memory voltage. The cool Hardware Monitor smartly indicates the temperatures, voltage and CPU fan speed as well as the chipset information. Also, in the About panel, you can get detail descriptions about BIOS model and chipsets. In addition, the frequency status of CPU, memory, AGP and PCI along with the CPU speed are synchronically shown on our main panel.

Moreover, to protect users' computer systems if the setting is not appropriate when testing and results in system fail or hang, [WarpSpeeder™] technology assures the system stability by automatically rebooting the computer and then restart to a speed that is either the original system speed or a suitable one.

System Requirement

OS Support: Windows 98 SE, Windows Me, Windows 2000, Windows XP

DirectX: DirectX 8.1 or above. (The Windows XP operating system includes DirectX 8.1. If you use Windows XP, you do not need to install DirectX 8.1.)

Installation

1. Execute the setup execution file, and then the following dialog will pop up. Please click "Next" button and follow the default procedure to install.

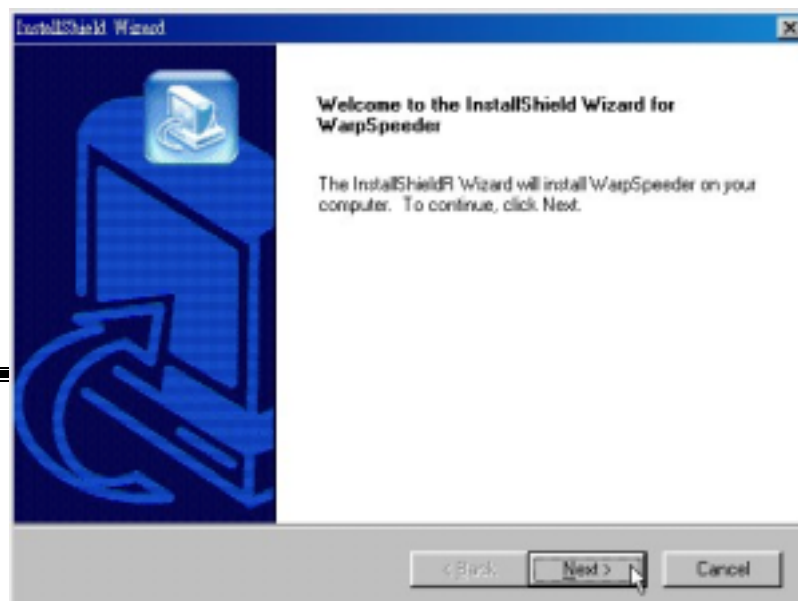

Motherboard Description

2. When you see the following dialog in setup procedure, it means setup is completed. If the "Launch the WarpSpeeder Tray Utility" checkbox is checked, the Tray Icon utility and [WarpSpeeder™] utility will be automatically and immediately launched after you click "Finish" button.

www.DataSheet4U.com

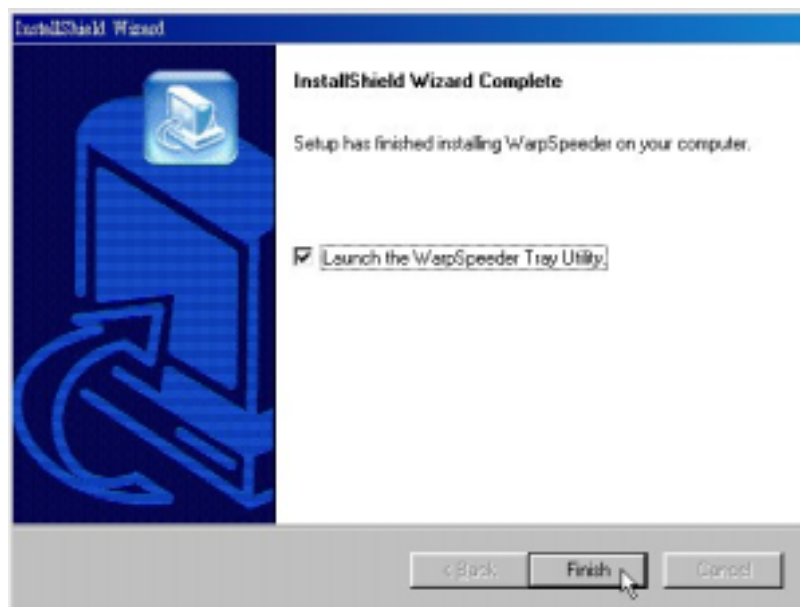

Usage

The following figures are just only for reference, the screen printed in this user manual will change according to your motherboard on hand.

[WarpSpeeder™] includes 1 tray icon and 5 panels:

1. Tray Icon:

Motherboard Description

Whenever the Tray Icon utility is launched, it will display a little tray icon on the right side of Windows Taskbar.



This utility is responsible for conveniently invoking [WarpSpeeder™] Utility. You can use the mouse by clicking the left button in order to invoke [WarpSpeeder™] directly from the little tray icon or you can right-click the little tray icon to pop up a popup menu as following figure. The “Launch Utility” item in the popup menu has the same function as mouse left-click on tray icon and “Exit” item will close Tray Icon utility if selected.

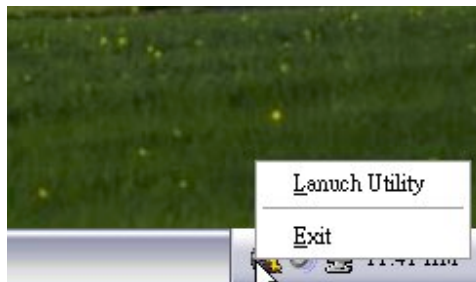

2. Main Panel

If you click the tray icon, [WarpSpeeder™] utility will be invoked. Please refer do the following figure; the utility's first window you will see is Main Panel.

Main Panel contains features as follows:

- a. Display the CPU Speed, CPU external clock, Memory clock, AGP clock, and PCI clock information.
- b. Contains About, Voltage, Overclock, and Hardware Monitor Buttons for invoking respective panels.
- c. With a user-friendly Status Animation, it can represent 3 overclock percentage stages:

Motherboard Description

Man walking => overclock percentage from 100% ~ 110 %

Panther running => overclock percentage from 110% ~ 120%

Car racing => overclock percentage from 120% ~ above

www.DataSheet4U.com

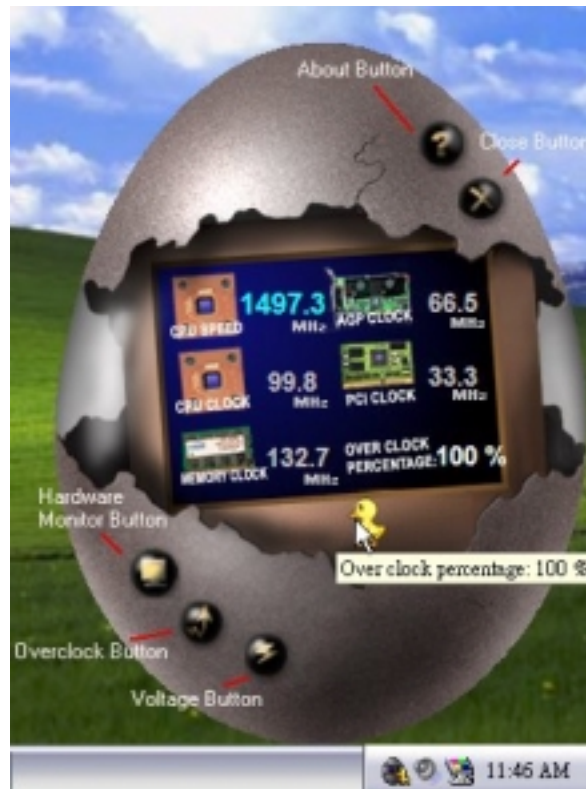

3. Voltage Panel

Click the Voltage button in Main Panel, the button will be highlighted and the Voltage Panel will slide out to up as the following figure.

In this panel, you can decide to increase CPU core voltage and Memory voltage or not. The default setting is "No". If you want to get the best performance of overclocking, we recommend you click the option "Yes".

Motherboard Description

www.DataSheet4U.com



4. Overclock Panel

Click the Overclock button in Main Panel, the button will be highlighted and the Overclock Panel will slide out to left as the following figure.

Motherboard Description



Overclock Panel contains the these features:

- a. “-3MHz button”, “-1MHz button”, “+1MHz button”, and “+3MHz button”: provide user the ability to do real-time overclock adjustment.

Warning: Manually overclock is potentially dangerous, especially when the overclocking percentage is over 110 %. We strongly recommend you verify every speed you overclock by click the Verify button. Or, you can just click Auto overclock button and let [WarpSpeeder™] automatically gets the best result for you.

- b. “Recovery Dialog button”: Pop up the following dialog. Let user select a restoring way if system need to do a fail-safe reboot.

Motherboard Description

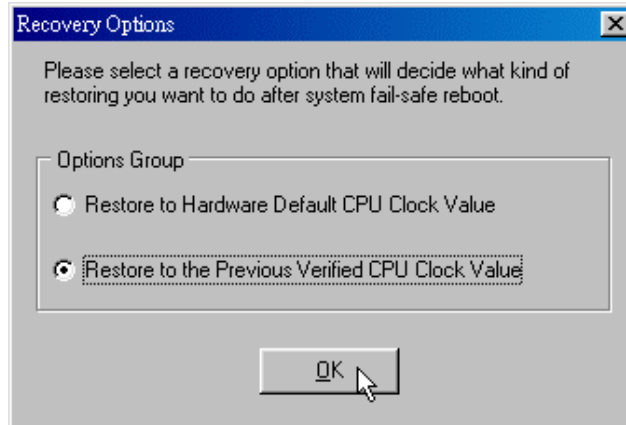

- d. "Auto-overclock button": User can click this button and [WarpSpeeder™] will set the best and stable performance and frequency automatically. [WarpSpeeder™] utility will execute a series of testing until system fail. Then system will do fail-safe reboot by using Watchdog function. After reboot, the [WarpSpeeder™] utility will restore to the hardware default setting or load the verified best and stable frequency according to the Recovery Dialog's setting.
- e. "Verify button": User can click this button and [WarpSpeeder™] will proceed a testing for current frequency. If the testing is ok, then the current frequency will be saved into system registry. If the testing fail, system will do a fail-safe rebooting. After reboot, the [WarpSpeeder™] utility will restore to the hardware default setting or load the verified best and stable frequency according to the Recovery Dialog's setting.

Note: Because the testing programs, invoked in Auto-overclock and Verify, include DirectDraw, Direct3D and DirectShow tests, the DirectX 8.1 or newer runtime library is required. And please make sure your display card's color depth is High color (16 bit) or True color(24/32 bit) that is required for Direct3D rendering.

Motherboard Description

5. Hardware Monitor Panel

Click the Hardware Monitor button in Main Panel, the button will be highlighted and the Hardware Monitor panel will slide out to left as the following figure.

In this panel, you can get the real-time status information of your system. The information will be refreshed every 1 second.



6. About Panel

Click the About button in Main Panel, the button will be highlighted and the About Panel will slide out to up as the following figure.

In this panel, you can get model name and detail information in hints of all the chipset that are related to overclocking. You can also get the mainboard's BIOS model and the Version number of [WarpSpeeder™] utility.

Motherboard Description



Note: Because the overclock, overvoltage, and hardware monitor features are controlled by several separate chipset, [WarpSpeeder™] divide these features to separate panels. If one chipset is not on board, the correlative button in Main panel will be disabled, but will not interfere other panels' functions. This property can make [WarpSpeeder™] utility more robust.

Motherboard Description

Trouble Shooting

PROBABLE	SOLUTION
No power to the system at all Power light don't illuminate, fan inside power supply does not turn on. Indicator light on keyboard does not turn on	<ul style="list-style-type: none"> * Make sure power cable is securely plugged in * Replace cable * Contact technical support
System inoperative. Keyboard lights are on, power indicator lights are lit, hard drive is spinning.	<ul style="list-style-type: none"> * Using even pressure on both ends of the DIMM, press down firmly until the module snaps into place.
System does not boot from hard disk drive, can be booted from CD-ROM drive.	<ul style="list-style-type: none"> * Check cable running from disk to disk controller board. Make sure both ends are securely plugged in; check the drive type in the standard CMOS setup. * Backing up the hard drive is extremely important. All hard disks are capable of breaking down at any time.
System only boots from CD-ROM. Hard disk can be read and applications can be used but booting from hard disk is impossible.	<ul style="list-style-type: none"> * Back up data and applications files. Reformat the hard drive. Re-install applications and data using backup disks.
Screen message says "Invalid Configuration" or "CMOS Failure."	<ul style="list-style-type: none"> * Review system's equipment . Make sure correct information is in setup.
Cannot boot system after installing second hard drive.	<ul style="list-style-type: none"> * Set master/slave jumpers correctly. * Run SETUP program and select correct drive types. Call drive manufacturers for compatibility with other drives.

Motherboard Description

Solución de Problemas

www.DataSheet4U.com

CAUSA PROBABLE	SOLUCIÓN
No hay corriente en el sistema. La luz de corriente no ilumina, ventilador dentro de la fuente de alimentación apagada. Indicador de luz del teclado apagado.	* Asegúrese que el cable de transmisión esté seguramente enchufado. * Reemplace el cable. * Contacte ayuda técnica.

CAUSA PROBABLE	SOLUCIÓN
Sistema inoperativo. Luz del teclado encendido, luz de indicador de corriente iluminado, disco rígido está girando.	* Presione los dos extremos del DIMM, presione para abajo firmemente hasta que el módulo encaje en el lugar.

CAUSA PROBABLE	SOLUCIÓN
Sistema no arranca desde el disco rígido, puede ser arrancado desde el CD-ROM drive.	* Controle el cable de ejecución desde el disco hasta el disco del controlador. Asegúrese de que ambos lados estén enchufados con seguridad; controle el tipo de disco en la configuración estándar CMOS. * Copiando el disco rígido es extremadamente importante. Todos los discos rígidos son capaces de dañarse en cualquier momento.

CAUSA PROBABLE	SOLUCIÓN
Sistema solamente arranca desde el CD-ROM. Disco rígido puede leer y aplicaciones pueden ser usados pero el arranque desde el disco rígido es imposible.	* Copie datos y documentos de aplicación. Vuelva a formatear el disco rígido. Vuelva a instalar las aplicaciones y datos usando el disco de copiado.

CAUSA PROBABLE	SOLUCIÓN
Mensaje de pantalla "Invalid Configuration" o "CMOS Failure."	* Revise el equipo del sistema. Asegúrese de que la información configurada sea correcta.

CAUSA PROBABLE	SOLUCIÓN
No puede arrancar después de instalar el segundo disco rígido.	* Fije correctamente el puente master/esclavo. * Ejecute el programa SETUP y seleccione el tipo de disco correcto. Llame a una manufacturación del disco para compatibilidad con otros discos.

Motherboard Description

www.DataSheet4U.com

03/25/2003