

MMBT6520LT1G

High Voltage Transistor

PNP Silicon

Features

- These Devices are Pb-Free, Halogen Free/BFR Free and are RoHS Compliant

MAXIMUM RATINGS

Rating	Symbol	Value	Unit
Collector - Emitter Voltage	V_{CEO}	-350	Vdc
Collector - Base Voltage	V_{CBO}	-350	Vdc
Emitter - Base Voltage	V_{EBO}	-5.0	Vdc
Base Current	I_B	-250	mA
Collector Current - Continuous	I_C	-500	mAdc

THERMAL CHARACTERISTICS

Characteristic	Symbol	Max	Unit
Total Device Dissipation FR-5 Board, (Note 1) $T_A = 25^\circ\text{C}$ Derate above 25°C	P_D	225 1.8	mW mW/ $^\circ\text{C}$
Thermal Resistance, Junction-to-Ambient	$R_{\theta JA}$	556	$^\circ\text{C}/\text{W}$
Total Device Dissipation Alumina Substrate, (Note 2) $T_A = 25^\circ\text{C}$ Derate above 25°C	P_D	300 2.4	mW mW/ $^\circ\text{C}$
Thermal Resistance, Junction-to-Ambient	$R_{\theta JA}$	417	$^\circ\text{C}/\text{W}$
Junction and Storage Temperature	T_J, T_{stg}	-55 to +150	$^\circ\text{C}$

Stresses exceeding Maximum Ratings may damage the device. Maximum Ratings are stress ratings only. Functional operation above the Recommended Operating Conditions is not implied. Extended exposure to stresses above the Recommended Operating Conditions may affect device reliability.

1. FR-5 = 1.0 x 0.75 x 0.062 in.
2. Alumina = 0.4 x 0.3 x 0.024 in. 99.5% alumina.



ON Semiconductor®

<http://onsemi.com>

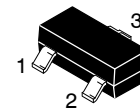
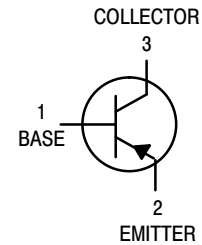

SOT-23 (TO-236)
CASE 318
STYLE 6

MARKING DIAGRAM

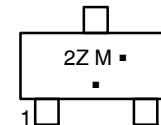

2Z = Device Code
M = Date Code*
■ = Pb-Free Package

(Note: Microdot may be in either location)

*Date Code orientation and/or overbar may vary depending upon manufacturing location.

ORDERING INFORMATION

Device	Package	Shipping†
MMBT6520LT1G	SOT-23 (Pb-Free)	3,000 / Tape & Reel
MMBT6520LT3G	SOT-23 (Pb-Free)	10,000/Tape & Reel

†For information on tape and reel specifications, including part orientation and tape sizes, please refer to our Tape and Reel Packaging Specifications Brochure, BRD8011/D.

MMBT6520LT1G

ELECTRICAL CHARACTERISTICS ($T_A = 25^\circ\text{C}$ unless otherwise noted)

Characteristic	Symbol	Min	Max	Unit
OFF CHARACTERISTICS				
Collector-Emitter Breakdown Voltage ($I_C = -1.0\text{ mA}$)	$V_{(BR)CEO}$	-350	-	Vdc
Collector-Base Breakdown Voltage ($I_C = -100\ \mu\text{A}$)	$V_{(BR)CBO}$	-350	-	Vdc
Emitter-Base Breakdown Voltage ($I_E = -10\ \mu\text{A}$)	$V_{(BR)EBO}$	-5.0	-	Vdc
Collector Cutoff Current ($V_{CB} = -250\text{ V}$)	I_{CBO}	-	-50	nA
Emitter Cutoff Current ($V_{EB} = -4.0\text{ V}$)	I_{EBO}	-	-50	nA
ON CHARACTERISTICS				
DC Current Gain ($I_C = -1.0\text{ mA}$, $V_{CE} = -10\text{ V}$) ($I_C = -10\text{ mA}$, $V_{CE} = -10\text{ V}$) ($I_C = -30\text{ mA}$, $V_{CE} = -10\text{ V}$) ($I_C = -50\text{ mA}$, $V_{CE} = -10\text{ V}$) ($I_C = -100\text{ mA}$, $V_{CE} = -10\text{ V}$)	h_{FE}	20 30 30 20 15	- - 200 200 -	-
Collector-Emitter Saturation Voltage ($I_C = -10\text{ mA}$, $I_B = -1.0\text{ mA}$) ($I_C = -20\text{ mA}$, $I_B = -2.0\text{ mA}$) ($I_C = -30\text{ mA}$, $I_B = -3.0\text{ mA}$) ($I_C = -50\text{ mA}$, $I_B = -5.0\text{ mA}$)	$V_{CE(sat)}$	- - - -	-0.30 -0.35 -0.50 -1.0	Vdc
Base-Emitter Saturation Voltage ($I_C = -10\text{ mA}$, $I_B = -1.0\text{ mA}$) ($I_C = -20\text{ mA}$, $I_B = -2.0\text{ mA}$) ($I_C = -30\text{ mA}$, $I_B = -3.0\text{ mA}$)	$V_{BE(sat)}$	- - -	-0.75 -0.85 -0.90	Vdc
Base-Emitter On Voltage ($I_C = -100\text{ mA}$, $V_{CE} = -10\text{ V}$)	$V_{BE(on)}$	-	-2.0	Vdc
SMALL-SIGNAL CHARACTERISTICS				
Current-Gain - Bandwidth Product ($I_C = -10\text{ mA}$, $V_{CE} = -20\text{ V}$, $f = 20\text{ MHz}$)	f_T	40	200	MHz
Collector-Base Capacitance ($V_{CB} = -20\text{ V}$, $f = 1.0\text{ MHz}$)	C_{cb}	-	6.0	pF
Emitter-Base Capacitance ($V_{EB} = -0.5\text{ V}$, $f = 1.0\text{ MHz}$)	C_{eb}	-	100	pF

MMBT6520LT1G

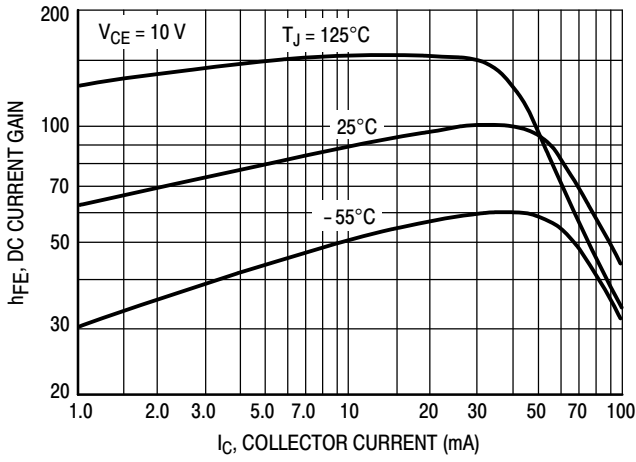

Figure 1. DC Current Gain

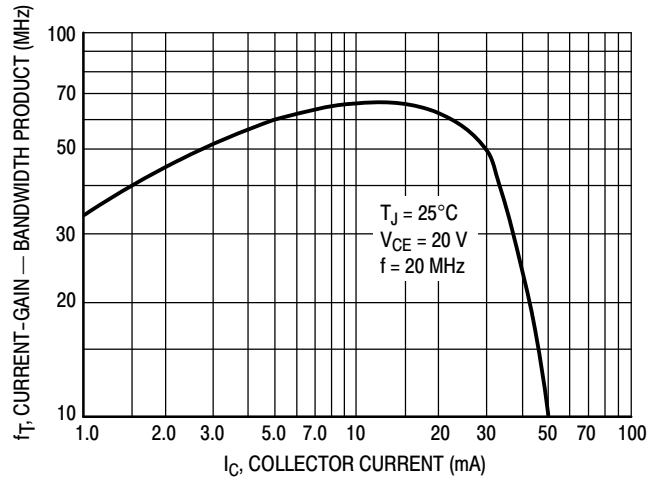

Figure 2. Current-Gain — Bandwidth Product

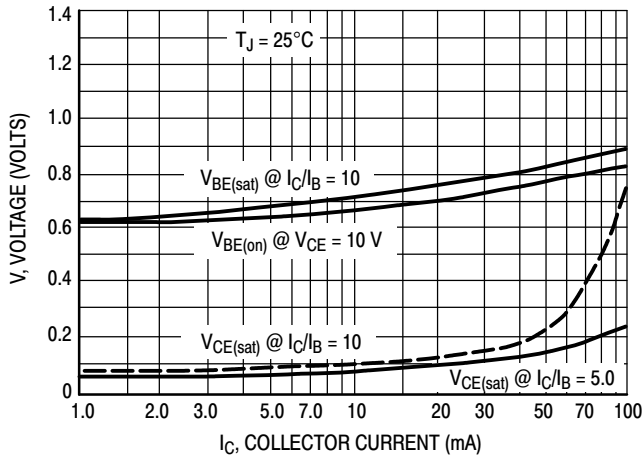

Figure 3. "On" Voltages

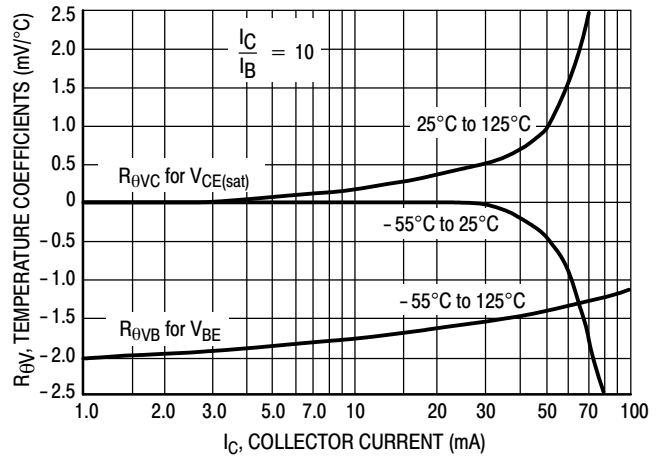

Figure 4. Temperature Coefficients

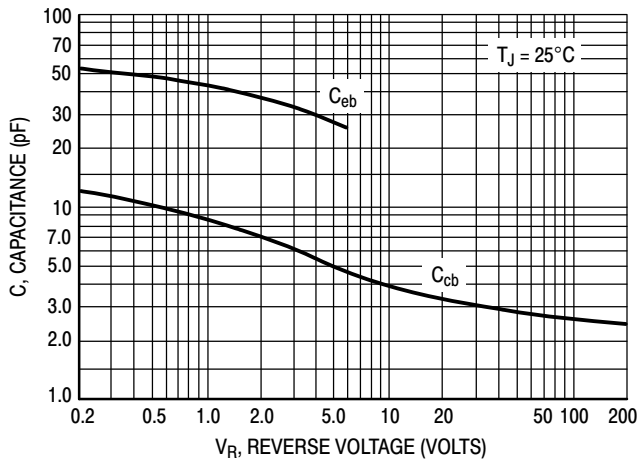

Figure 5. Capacitance

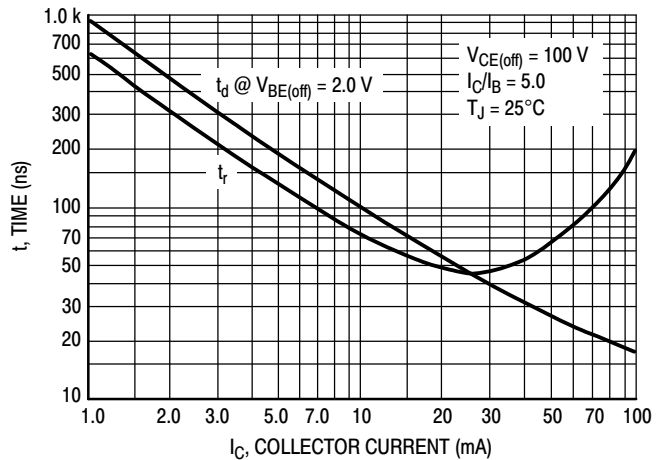

Figure 6. Turn-On Time

MMBT6520LT1G

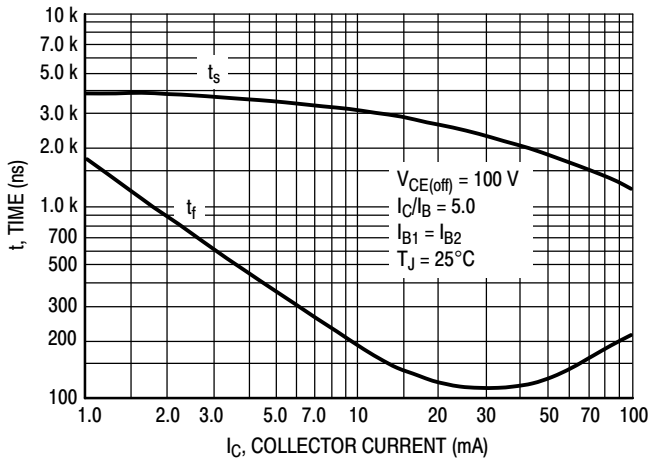

Figure 7. Turn-Off Time

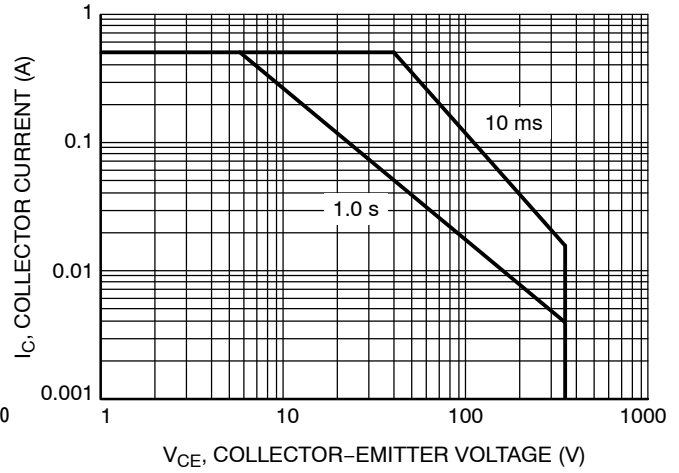

Figure 8. Safe Operating Area

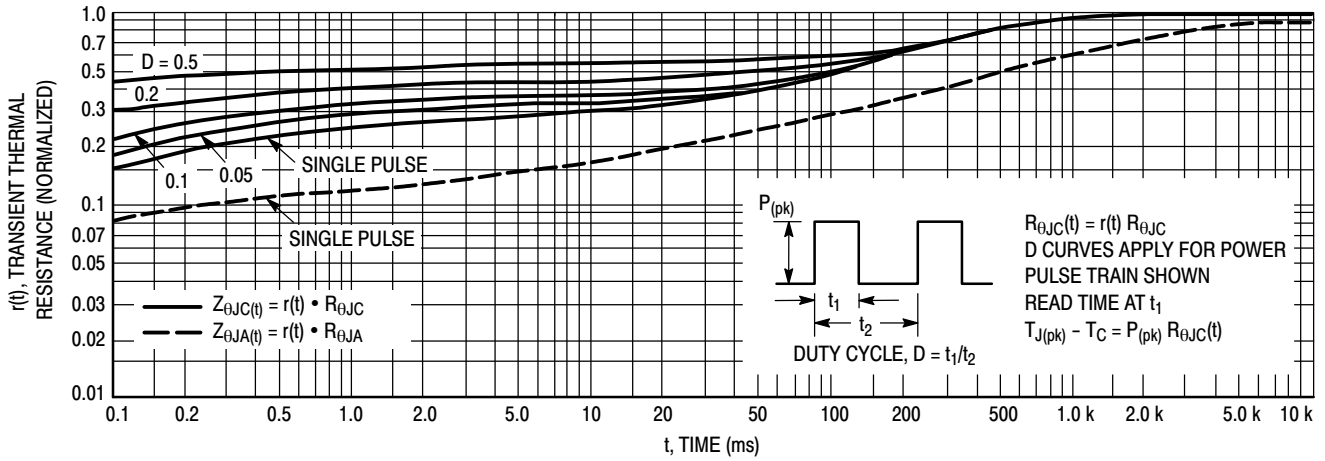

Figure 9. Thermal Response

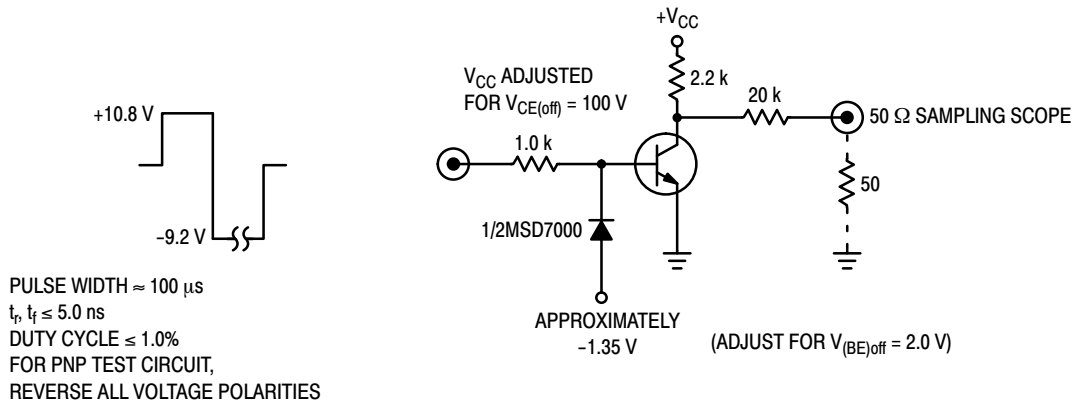
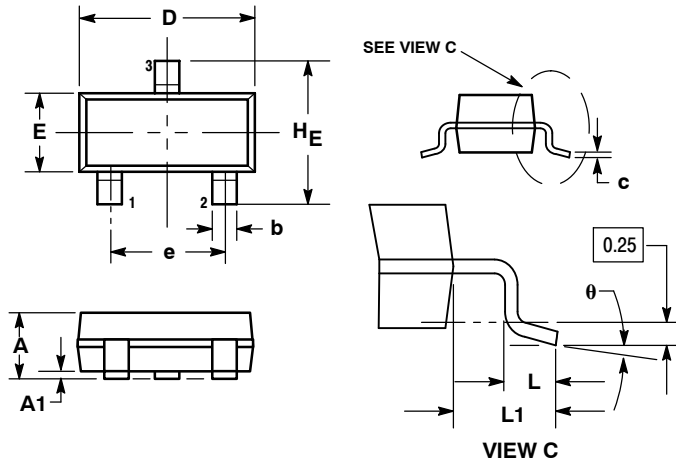

Figure 10. Switching Time Test Circuit

MMBT6520LT1G

PACKAGE DIMENSIONS

SOT-23 (TO-236)
CASE 318-08
ISSUE AP



NOTES:

1. DIMENSIONING AND TOLERANCING PER ANSI Y14.5M, 1982.
2. CONTROLLING DIMENSION: INCH.
3. MAXIMUM LEAD THICKNESS INCLUDES LEAD FINISH THICKNESS. MINIMUM LEAD THICKNESS IS THE MINIMUM THICKNESS OF BASE MATERIAL.
4. DIMENSIONS D AND E DO NOT INCLUDE MOLD FLASH, PROTRUSIONS, OR GATE BURRS.

DIM	MILLIMETERS			INCHES		
	MIN	NOM	MAX	MIN	NOM	MAX
A	0.89	1.00	1.11	0.035	0.040	0.044
A1	0.01	0.06	0.10	0.001	0.002	0.004
b	0.37	0.44	0.50	0.015	0.018	0.020
c	0.09	0.13	0.18	0.003	0.005	0.007
D	2.80	2.90	3.04	0.110	0.114	0.120
E	1.20	1.30	1.40	0.047	0.051	0.055
e	1.78	1.90	2.04	0.070	0.075	0.081
L	0.10	0.20	0.30	0.004	0.008	0.012
L1	0.35	0.54	0.69	0.014	0.021	0.029
HE	2.10	2.40	2.64	0.083	0.094	0.104
θ	0°	---	10°	0°	---	10°

STYLE 6:

1. BASE
2. EMITTER
3. COLLECTOR

SOLDERING FOOTPRINT*

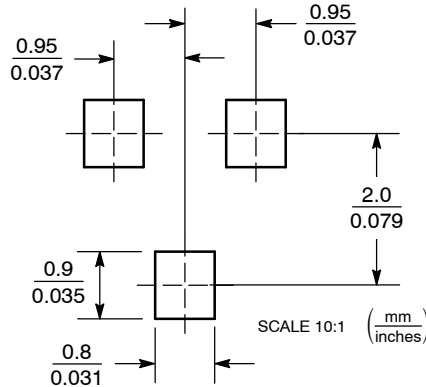

*For additional information on our Pb-Free strategy and soldering details, please download the ON Semiconductor Soldering and Mounting Techniques Reference Manual, SOLDERRM/D.

ON Semiconductor and are registered trademarks of Semiconductor Components Industries, LLC (SCILLC). SCILLC reserves the right to make changes without further notice to any products herein. SCILLC makes no warranty, representation or guarantee regarding the suitability of its products for any particular purpose, nor does SCILLC assume any liability arising out of the application or use of any product or circuit, and specifically disclaims any and all liability, including without limitation special, consequential or incidental damages. "Typical" parameters which may be provided in SCILLC data sheets and/or specifications can and do vary in different applications and actual performance may vary over time. All operating parameters, including "Typicals" must be validated for each customer application by customer's technical experts. SCILLC does not convey any license under its patent rights nor the rights of others. SCILLC products are not designed, intended, or authorized for use as components in systems intended for surgical implant into the body, or other applications intended to support or sustain life, or for any other application in which the failure of the SCILLC product could create a situation where personal injury or death may occur. Should Buyer purchase or use SCILLC products for any such unintended or unauthorized application, Buyer shall indemnify and hold SCILLC and its officers, employees, subsidiaries, affiliates, and distributors harmless against all claims, costs, damages, and expenses, and reasonable attorney fees arising out of, directly or indirectly, any claim of personal injury or death associated with such unintended or unauthorized use, even if such claim alleges that SCILLC was negligent regarding the design or manufacture of the part. SCILLC is an Equal Opportunity/Affirmative Action Employer. This literature is subject to all applicable copyright laws and is not for resale in any manner.

PUBLICATION ORDERING INFORMATION

LITERATURE FULFILLMENT:
Literature Distribution Center for ON Semiconductor
P.O. Box 5163, Denver, Colorado 80217 USA
Phone: 303-675-2175 or 800-344-3860 Toll Free USA/Canada
Fax: 303-675-2176 or 800-344-3867 Toll Free USA/Canada
Email: orderlit@onsemi.com

N. American Technical Support: 800-282-9855 Toll Free
USA/Canada
Europe, Middle East and Africa Technical Support:
Phone: 421 33 790 2910
Japan Customer Focus Center
Phone: 81-3-5773-3850

ON Semiconductor Website: www.onsemi.com

Order Literature: <http://www.onsemi.com/orderlit>

For additional information, please contact your local Sales Representative