

EVALUATION KIT  
AVAILABLE

# 1 $\mu$ A, 4-Bump UCSP/SOT23, Precision Current-Sense Amplifier

MAX9634

## General Description

The MAX9634 high-side current-sense amplifier offers precision accuracy specifications of  $V_{OS}$  less than 250 $\mu$ V (max) and gain error less than 0.5% (max). Quiescent supply current is an ultra-low 1 $\mu$ A. The MAX9634 fits in a tiny, 1mm x 1mm UCSP™ package size or a 5-pin SOT23 package, making the part ideal for applications in notebook computers, cell phones, PDAs, and all battery-operated portable devices where accuracy, low quiescent current, and small size are critical.

The MAX9634 features an input common-mode voltage range from 1.6V to 28V. These current-sense amplifiers have a voltage output and are offered in four gain versions: 25V/V (MAX9634T), 50V/V (MAX9634F), 100V/V (MAX9634H), and 200V/V (MAX9634W).

The four gain selections offer flexibility in the choice of the external current-sense resistor. The very low 250 $\mu$ V (max) input offset voltage allows small 25mV to 50mV full-scale  $V_{SENSE}$  voltage for very low voltage drop at full-current measurement.

The MAX9634 is offered in tiny 4-bump UCSP (1mm x 1mm x 0.6mm footprint) and 5-pin SOT23 packages specified for operation over the -40°C to +85°C extended temperature range.

## Applications

Cell Phones  
PDAs  
Power-Management Systems  
Portable/Battery-Powered Systems  
Notebook Computers

## Features

- ◆ Ultra-Low Supply Current of 1 $\mu$ A (max)
- ◆ Low 250 $\mu$ V (max) Input Offset Voltage
- ◆ Low < 0.5% (max) Gain Error
- ◆ Input Common Mode: +1.6V to +28V
- ◆ Voltage Output
- ◆ Four Gain Versions Available
  - 25V/V (MAX9634T)
  - 50V/V (MAX9634F)
  - 100V/V (MAX9634H)
  - 200V/V (MAX9634W)
- ◆ Tiny 1mm x 1mm x 0.6mm, 4-Bump UCSP or 5-Pin SOT23 Packages

## Ordering Information

PART	PIN-PACKAGE	GAIN (V/V)	TOP MARK
MAX9634TERS+	4 UCSP	25	+ABX
MAX9634FERS+	4 UCSP	50	+ABY
MAX9634HERS+	4 UCSP	100	+ABZ
MAX9634WERS+	4 UCSP	200	+ACA
MAX9634TEUK+	5 SOT23	25	+AFHG
MAX9634FEUK+	5 SOT23	50	+AFHH
MAX9634HEUK+	5 SOT23	100	+AFHI
MAX9634WEUK+	5 SOT23	200	+AFHJ

+Denotes a lead(Pb)-free/RoHS-compliant package.

**Note:** All devices are specified over the -40°C to +85°C extended temperature range.

UCSP is a trademark of Maxim Integrated Products, Inc.

## Pin Configurations

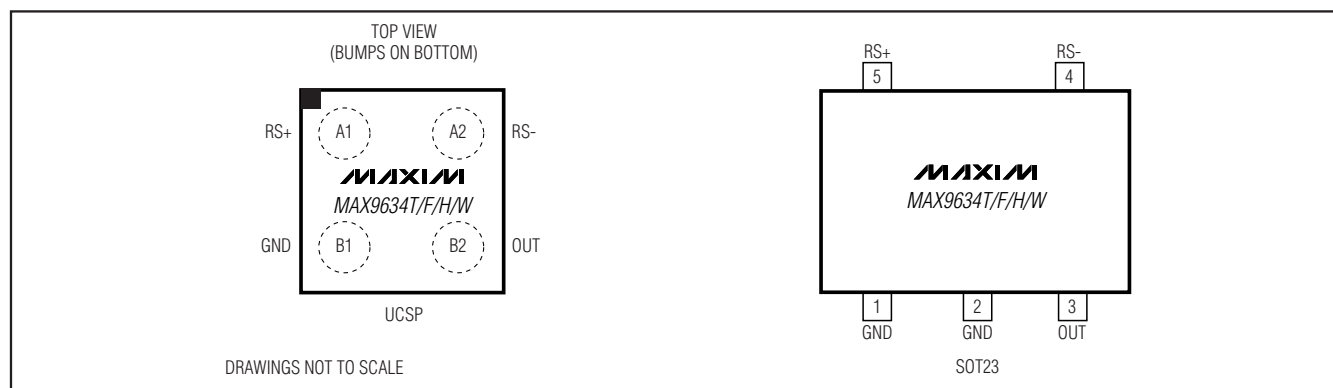

# 1 $\mu$ A, 4-Bump UCSP/SOT23, Precision Current-Sense Amplifier

MAX9634

## ABSOLUTE MAXIMUM RATINGS

RS+, RS- to GND	-0.3V to +30V
OUT to GND	-0.3V to +6V
RS+ to RS-	$\pm$ 30V
Short-Circuit Duration: OUT to GND	Continuous
Continuous Input Current (any pin)	$\pm$ 20mA
Continuous Power Dissipation (T <sub>A</sub> = +70°C)	
4-Bump UCSP (derate 3.0mW/°C above +70°C)	238mW
5-Pin SOT23 (derate 3.9mW/°C above +70°C)	312mW

Operating Temperature Range	-40°C to +85°C
Junction Temperature	+150°C
Storage Temperature Range	-65°C to +150°C
Bump Temperature (soldering) Reflow	+260°C
Lead Temperature (soldering, 10s)	+300°C
Lead Temperature (reflow)	+260°C

Stresses beyond those listed under "Absolute Maximum Ratings" may cause permanent damage to the device. These are stress ratings only, and functional operation of the device at these or any other conditions beyond those indicated in the operational sections of the specifications is not implied. Exposure to absolute maximum rating conditions for extended periods may affect device reliability.

## ELECTRICAL CHARACTERISTICS

(V<sub>RS+</sub> = V<sub>RS-</sub> = 3.6V, V<sub>SENSE</sub> = (V<sub>RS+</sub> - V<sub>RS-</sub>) = 0V, T<sub>A</sub> = -40°C to +85°C, unless otherwise noted. Typical values are at T<sub>A</sub> = +25°C.) (Note 1)

PARAMETER	SYMBOL	CONDITIONS	MIN	TYP	MAX	UNITS
Supply Current (Note 2)	I <sub>CC</sub>	V <sub>RS+</sub> = 5V, T <sub>A</sub> = +25°C		0.5	0.85	$\mu$ A
		V <sub>RS+</sub> = 5V, -40°C < T <sub>A</sub> < +85°C			1.1	
		V <sub>RS+</sub> = 28V, T <sub>A</sub> = +25°C		1.1	1.8	
		V <sub>RS+</sub> = 28V, -40°C < T <sub>A</sub> < +85°C			2.5	
Common-Mode Input Range	V <sub>CM</sub>	Guaranteed by CMRR, -40°C < T <sub>A</sub> < +85°C	1.6		28	V
Common-Mode Rejection Ratio	CMRR	1.6V < V <sub>RS+</sub> < 28V, -40°C < T <sub>A</sub> < +85°C	94	130		dB
Input Offset Voltage (Note 3)	V <sub>OS</sub>	MAX9634T/MAX9634F/ MAX9634H	T <sub>A</sub> = +25°C	100	250	$\mu$ V
			-40°C < T <sub>A</sub> < +85°C		300	
		MAX9634W	T <sub>A</sub> = +25°C	100	250	
			-40°C < T <sub>A</sub> < +85°C		425	
Gain	G	MAX9634T		25		V/V
		MAX9634F		50		
		MAX9634H		100		
		MAX9634W		200		
Gain Error (Note 4)	GE	T <sub>A</sub> = +25°C		$\pm$ 0.1	$\pm$ 0.5	%
		-40°C < T <sub>A</sub> < +85°C			$\pm$ 0.6	
Output Resistance (Note 5)	R <sub>OUT</sub>	MAX9634T/MAX9634F/MAX9634H	7.0	10	13.2	k $\Omega$
		MAX9634W	14.0	20	26.4	
OUT Low Voltage	V <sub>OL</sub>	Gain = 25		1.5	7.5	mV
		Gain = 50		3	15	
		Gain = 100		6	30	
		Gain = 200		12	85	

# 1 $\mu$ A, 4-Bump UCSP/SOT23, Precision Current-Sense Amplifier

MAX9634

## ELECTRICAL CHARACTERISTICS (continued)

( $V_{RS+} = V_{RS-} = 3.6V$ ,  $V_{SENSE} = (V_{RS+} - V_{RS-}) = 0V$ ,  $T_A = -40^{\circ}C$  to  $+85^{\circ}C$ , unless otherwise noted. Typical values are at  $T_A = +25^{\circ}C$ .) (Note 1)

PARAMETER	SYMBOL	CONDITIONS	MIN	TYP	MAX	UNITS
OUT High Voltage	$V_{OH}$	$V_{OH} = V_{RS-} - V_{OUT}$ (Note 6)		0.1	0.2	V
Small-Signal Bandwidth (Note 5)	BW	$V_{SENSE} = 50mV$ , gain = 25		125		kHz
		$V_{SENSE} = 50mV$ , gain = 50		60		
		$V_{SENSE} = 50mV$ , gain = 100		30		
		$V_{SENSE} = 50mV$ , gain = 200		15		
Output Settling Time	$t_S$	1% final value, $V_{SENSE} = 50mV$		100		$\mu s$
Power-Up Time	$t_{ON}$	1% final value, $V_{SENSE} = 50mV$		200		$\mu s$

**Note 1:** All devices are 100% production tested at  $T_A = +25^{\circ}C$ . All temperature limits are guaranteed by design.

**Note 2:**  $V_{OUT} = 0$ .  $I_{CC}$  is the total current into  $RS+$  plus  $RS-$  pins.

**Note 3:**  $V_{OS}$  is extrapolated from measurements for the gain-error test.

**Note 4:** Gain error is calculated by applying two values of  $V_{SENSE}$  and calculating the error of the slope vs. the ideal:

Gain = 25,  $V_{SENSE}$  is 20mV and 120mV.

Gain = 50,  $V_{SENSE}$  is 10mV and 60mV.

Gain = 100,  $V_{SENSE}$  is 5mV and 30mV.

Gain = 200,  $V_{SENSE}$  is 2.5mV and 15mV.

**Note 5:** The device is stable for any external capacitance value.

**Note 6:**  $V_{OH}$  is the voltage from  $V_{RS-}$  to  $V_{OUT}$  with  $V_{SENSE} = 3.6V/gain$ .

## Typical Operating Characteristics

( $V_{RS+} = V_{RS-} = 3.6V$ ,  $T_A = +25^{\circ}C$ , unless otherwise noted.)

www.DataSheet4U.com

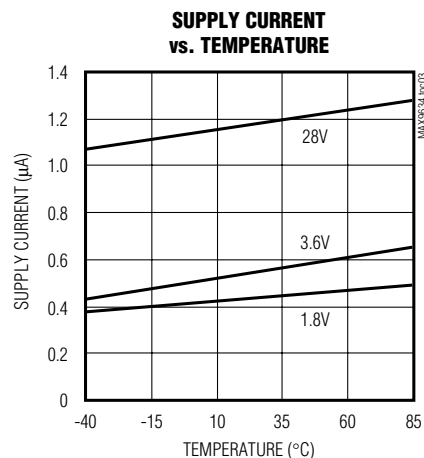
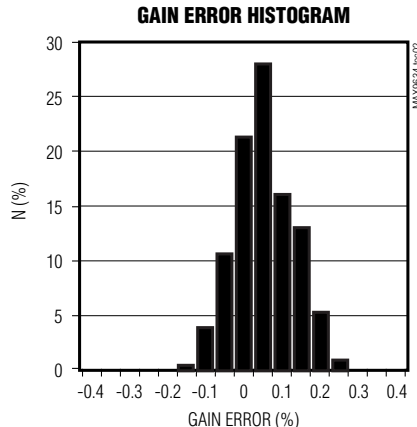
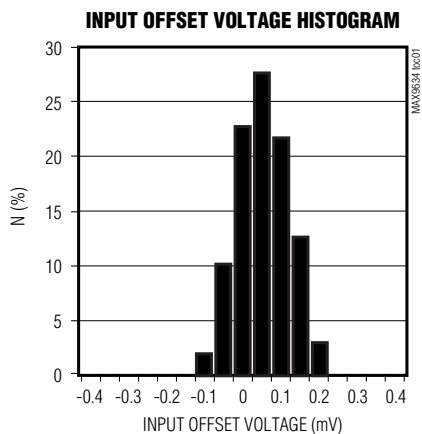

# 1μA, 4-Bump UCSP/SOT23, Precision Current-Sense Amplifier

MAX9634

## Typical Operating Characteristics (continued)

( $V_{RS+} = V_{RS-} = 3.6V$ ,  $T_A = +25^{\circ}C$ , unless otherwise noted.)

**INPUT OFFSET vs. COMMON-MODE VOLTAGE**

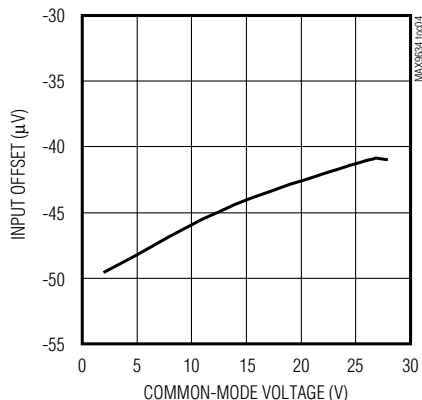

**INPUT OFFSET vs. TEMPERATURE**

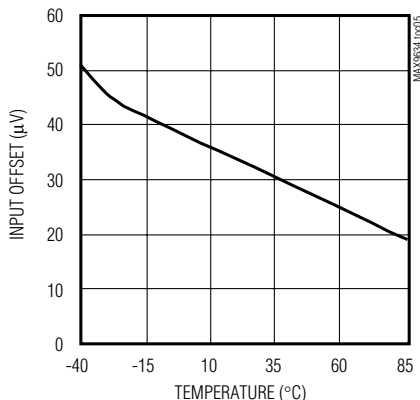

**SUPPLY CURRENT vs. COMMON-MODE VOLTAGE**

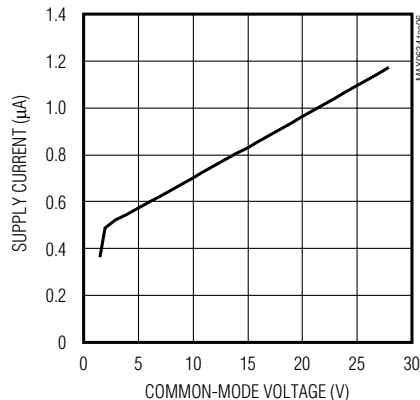

**GAIN ERROR vs. COMMON-MODE VOLTAGE**

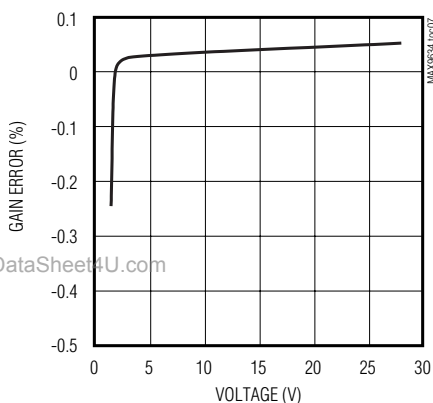

**GAIN ERROR vs. TEMPERATURE**

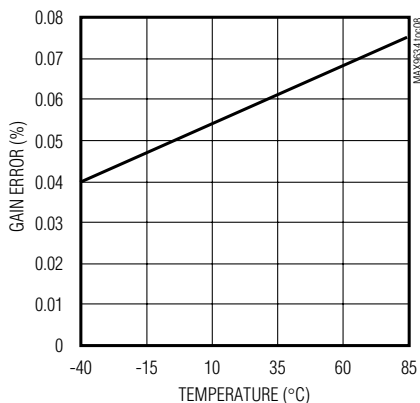

**V<sub>OUT</sub> vs. V<sub>SENSE</sub> (SUPPLY = 3.6V)**

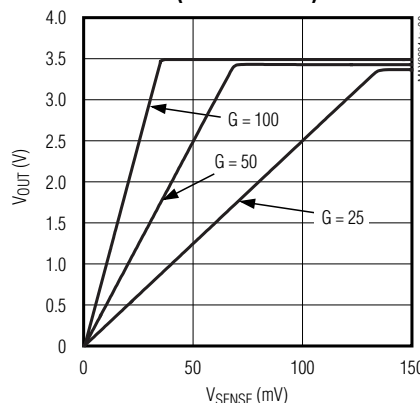

**V<sub>OUT</sub> vs. V<sub>SENSE</sub> (SUPPLY = 1.6V)**

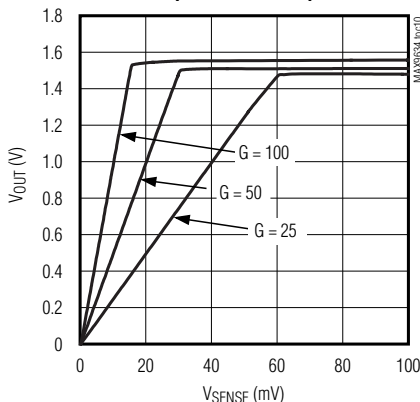

**SMALL-SIGNAL GAIN vs. FREQUENCY**

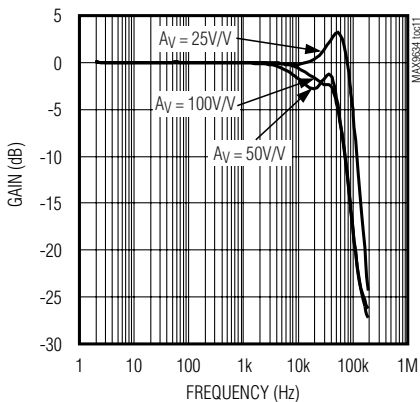

**CMRR vs. FREQUENCY**

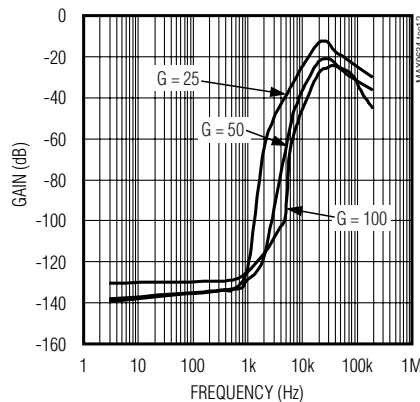

# 1 $\mu$ A, 4-Bump UCSP/SOT23, Precision Current-Sense Amplifier

## Typical Operating Characteristics (continued)

( $V_{RS+} = V_{RS-} = 3.6V$ ,  $T_A = +25^\circ C$ , unless otherwise noted.)

MAX9634

**SMALL-SIGNAL PULSE RESPONSE  
(GAIN = 100)**

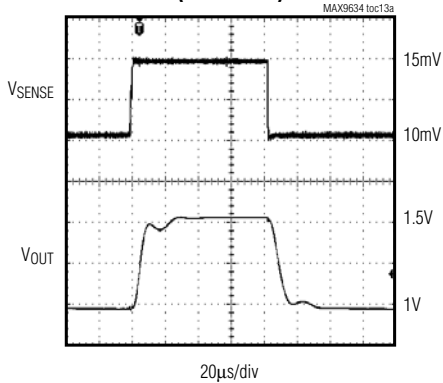

**SMALL-SIGNAL PULSE RESPONSE  
(GAIN = 50)**

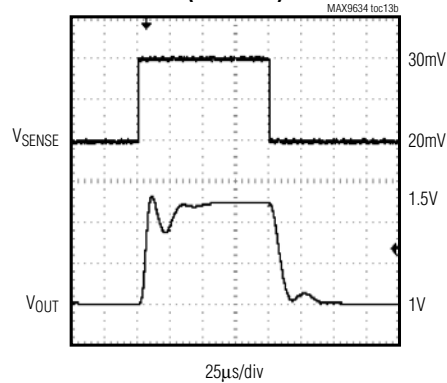

**SMALL-SIGNAL PULSE RESPONSE  
(GAIN = 25)**

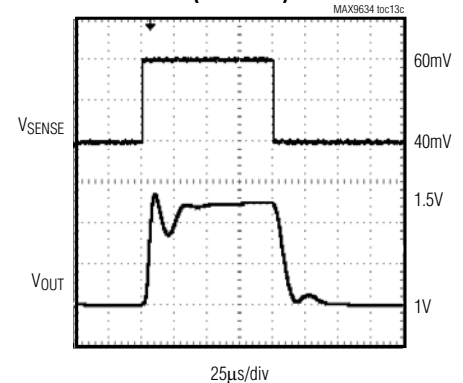

**LARGE-SIGNAL PULSE RESPONSE  
(GAIN = 100)**

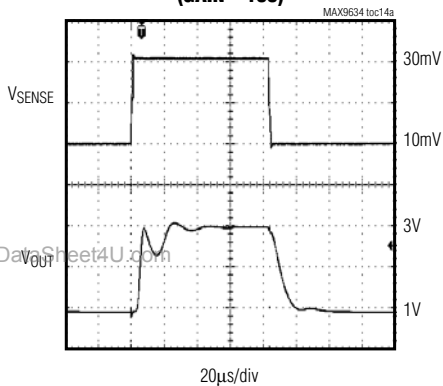

**LARGE-SIGNAL PULSE RESPONSE  
(GAIN = 50)**

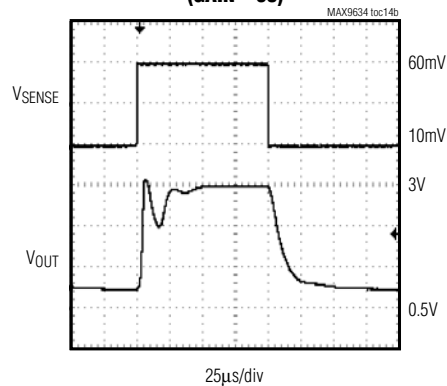

**LARGE-SIGNAL PULSE RESPONSE  
(GAIN = 25)**

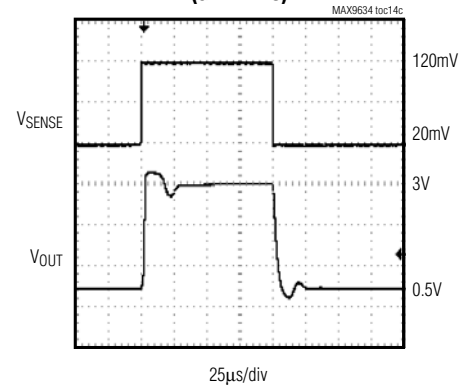

## Pin Description

PIN		NAME	FUNCTION
UCSP	SOT23		
A1	5	RS+	External Sense Resistor Power-Side Connection
A2	4	RS-	External Sense Resistor Load-Side Connection
B1	1, 2	GND	Ground
B2	3	OUT	Output Voltage. $V_{OUT}$ is proportional to $V_{SENSE} = V_{RS+} - V_{RS-}$ .

# 1 $\mu$ A, 4-Bump UCSP/SOT23, Precision Current-Sense Amplifier

MAX9634

## Typical Operating Circuit

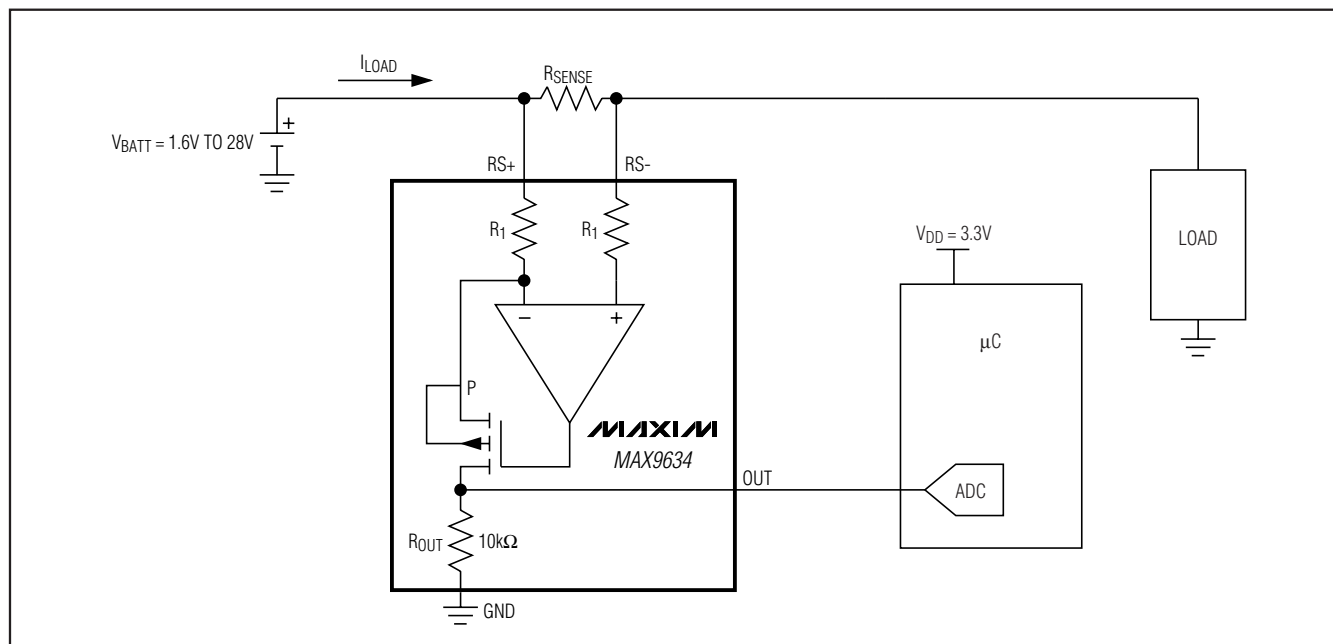

### Detailed Description

The MAX9634 unidirectional high-side, current-sense amplifier features a 1.6V to 28V input common-mode range. This feature allows the monitoring of current out of a battery with a voltage as low as 1.6V. The MAX9634 monitors current through a current-sense resistor and amplifies the voltage across that resistor.

The MAX9634 is a unidirectional current-sense amplifier that has a well-established history. An op amp is used to force the current through an internal gain resistor at RS+, which has a value of R<sub>1</sub>, such that its voltage drop equals the voltage drop across an external sense resistor, R<sub>SENSE</sub>. There is an internal resistor at RS- with the

same value as R<sub>1</sub> to minimize offset voltage. The current through R<sub>1</sub> is sourced by a high-voltage p-channel FET. Its source current is the same as its drain current, which flows through a second gain resistor, R<sub>OUT</sub>. This produces an output voltage, V<sub>OUT</sub>, whose magnitude is I<sub>LOAD</sub> × R<sub>SENSE</sub> × R<sub>OUT</sub>/R<sub>1</sub>. The gain accuracy is based on the matching of the two gain resistors R<sub>1</sub> and R<sub>OUT</sub> (see Table 1). Total gain = 25V/V for the MAX9634T, 50V/V for the MAX9634F, 100V/V for the MAX9634H, and 200V/V for the MAX9634W. The output is protected from input overdrive by use of an output current-limiting circuit of 7mA (typical) and a 6V clamp protection circuit.

**Table 1. Internal Gain-Setting Resistors  
(Typical Values)**

GAIN (V/V)	R <sub>1</sub> (Ω)	R <sub>OUT</sub> (kΩ)
200	100	20
100	100	10
50	200	10
25	400	10

### Applications Information

#### Choosing the Sense Resistor

Choose R<sub>SENSE</sub> based on the following criteria:

#### Voltage Loss

A high R<sub>SENSE</sub> value causes the power-source voltage to drop due to IR loss. For minimal voltage loss, use the lowest R<sub>SENSE</sub> value.

# 1μA, 4-Bump UCSP/SOT23, Precision Current-Sense Amplifier

MAX9634

## OUT Swing vs. $V_{RS+}$ and $V_{SENSE}$

The MAX9634 is unique because the supply voltage is the input common-mode voltage (the average voltage at  $RS+$  and  $RS-$ ). There is no separate  $V_{CC}$  supply voltage pin. Therefore, the OUT voltage swing is limited by the minimum voltage at  $RS+$ .

$$V_{OUT}(\max) = V_{RS+}(\min) - V_{SENSE}(\max) - V_{OH}$$

and:

$$R_{SENSE} = \frac{V_{OUT}(\max)}{G \times I_{LOAD}(\max)}$$

$V_{SENSE}$  full scale should be less than  $V_{OUT}/GAIN$  at the minimum  $RS+$  voltage. For best performance with a 3.6V supply voltage, select  $R_{SENSE}$  to provide approximately 120mV (gain of 25V/V), 60mV (gain of 50V/V), 30mV (gain of 100V/V), or 15mV (gain of 200V/V) of sense voltage for the full-scale current in each application. These can be increased by use of a higher minimum input voltage.

## Accuracy

In the linear region ( $V_{OUT} < V_{OUT}(\max)$ ), there are two components to accuracy: input offset voltage ( $V_{OS}$ ) and gain error (GE). For the MAX9634,  $V_{OS} = 250\mu V$  (max) and gain error is 0.5% (max). Use the linear equation:

$$V_{OUT} = (\text{gain} \pm \text{GE}) \times V_{SENSE} \pm (\text{gain} \times V_{OS})$$

to calculate total error. A high  $R_{SENSE}$  value allows lower currents to be measured more accurately because offsets are less significant when the sense voltage is larger.

## Efficiency and Power Dissipation

At high current levels, the  $I^2R$  losses in  $R_{SENSE}$  can be significant. Take this into consideration when choosing the resistor value and its power dissipation (wattage) rating. Also, the sense resistor's value might drift if it is allowed to heat up excessively. The precision  $V_{OS}$  of the MAX9634 allows the use of small sense resistors to reduce power dissipation and reduce hot spots.

## Kelvin Connections

Because of the high currents that flow through  $R_{SENSE}$ , take care to eliminate parasitic trace resistance from causing errors in the sense voltage. Either use a four-terminal current-sense resistor or use Kelvin (force and sense) PCB layout techniques.

## Optional Output Filter Capacitor

When designing a system that uses a sample-and-hold stage in the ADC, the sampling capacitor momentarily loads OUT and causes a drop in the output voltage. If sampling time is very short (less than a microsecond), consider using a ceramic capacitor across OUT and GND to hold  $V_{OUT}$  constant during sampling. This also decreases the small-signal bandwidth of the current-sense amplifier and reduces noise at OUT.

# 1 $\mu$ A, 4-Bump UCSP/SOT23, Precision Current-Sense Amplifier

MAX9634

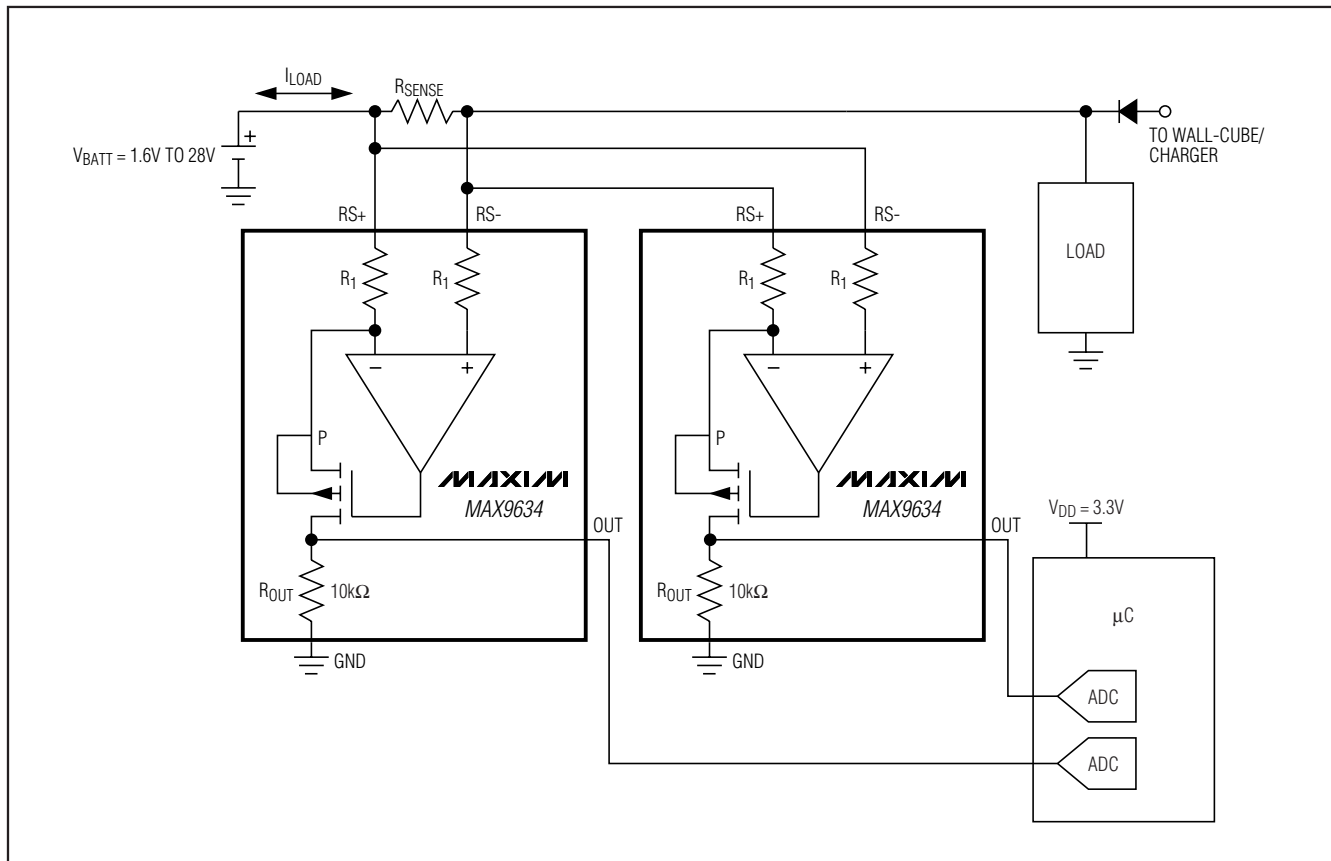

Figure 1. Bidirectional Application

www.DataSheet4U.com

## **Bidirectional Application**

Battery-powered systems may require a precise bidirectional current-sense amplifier to accurately monitor the battery's charge and discharge currents. Measurements of the two separate outputs with respect to GND yields an accurate measure of the charge and discharge currents, respectively (Figure 1).

## **UCSP Applications Information**

For the latest application details on UCSP construction, dimensions, tape carrier information, PCB techniques, bump-pad layout, and recommended reflow temperature profile, as well as the latest information on reliability testing results, refer to the Application Note 1891: *Understanding the Basics of the Wafer-Level Chip-Scale Package (WL-CSP)* available on Maxim's website at [www.maxim-ic.com/ucsp](http://www.maxim-ic.com/ucsp).

## **Chip Information**

PROCESS: BiCMOS



# 1µA, 4-Bump UCSP/SOT23, Precision Current-Sense Amplifier

**MAX9634**

## Package Information

For the latest package outline information and land patterns, go to [www.maxim-ic.com/packages](http://www.maxim-ic.com/packages). Note that a "+", "#", or "-" in the package code indicates RoHS status only. Package drawings may show a different suffix character, but the drawing pertains to the package regardless of RoHS status.

PACKAGE TYPE	PACKAGE CODE	DOCUMENT NO.
2 x 2 UCSP	R41A1+1	<a href="#">21-0242</a>
5 SOT23	U5-2	<a href="#">21-0057</a>

**TOP VIEW**

COMMON DIMENSIONS	
A	0.64±0.05
A1	0.24±0.03
b	∅0.31 REF
D1	0.50 BASIC
E1	0.50 BASIC
e	0.50 BASIC
SD	0.25 BASIC
SE	0.25 BASIC

PKG. CODE	VARIABLE DIMENSIONS		DEPOPULATED BUMPS
	E	D	
R41A1+1	1.00±0.05	1.00±0.05	NONE
R41B1+1	1.05±0.05	1.05±0.05	NONE
R41C1+1	1.10±0.05	1.10±0.05	NONE

**BOTTOM VIEW**

**SIDE VIEW**

**NOTES:**

- Terminal pitch is defined by terminal center to center value.
- Outer dimension (D & E) is defined by center lines between scribe lines.
- All dimensions in millimeters.
- Marking shown is for package orientation reference only.
- Tolerance is ± 0.02mm unless specified otherwise.
- All dimensions apply to PbFree (+) package codes only.

**TITLE:**  
Package Outline, 4 bumps,  
2x2 array, UCSP (R) pkg. 0.5mm pitch

APPROVAL	DOCUMENT CONTROL NO. 21-0242	REV. A	1/1
----------	---------------------------------	-----------	-----

-DRAWING NOT TO SCALE-

2x2 UCSP:EPS

www.DataSheet4U.com

# 1μA, 4-Bump UCSP/SOT23, Precision Current-Sense Amplifier

MAX9634

## Package Information (continued)

For the latest package outline information and land patterns, go to [www.maxim-ic.com/packages](http://www.maxim-ic.com/packages). Note that a "+", "#", or "-" in the package code indicates RoHS status only. Package drawings may show a different suffix character, but the drawing pertains to the package regardless of RoHS status.

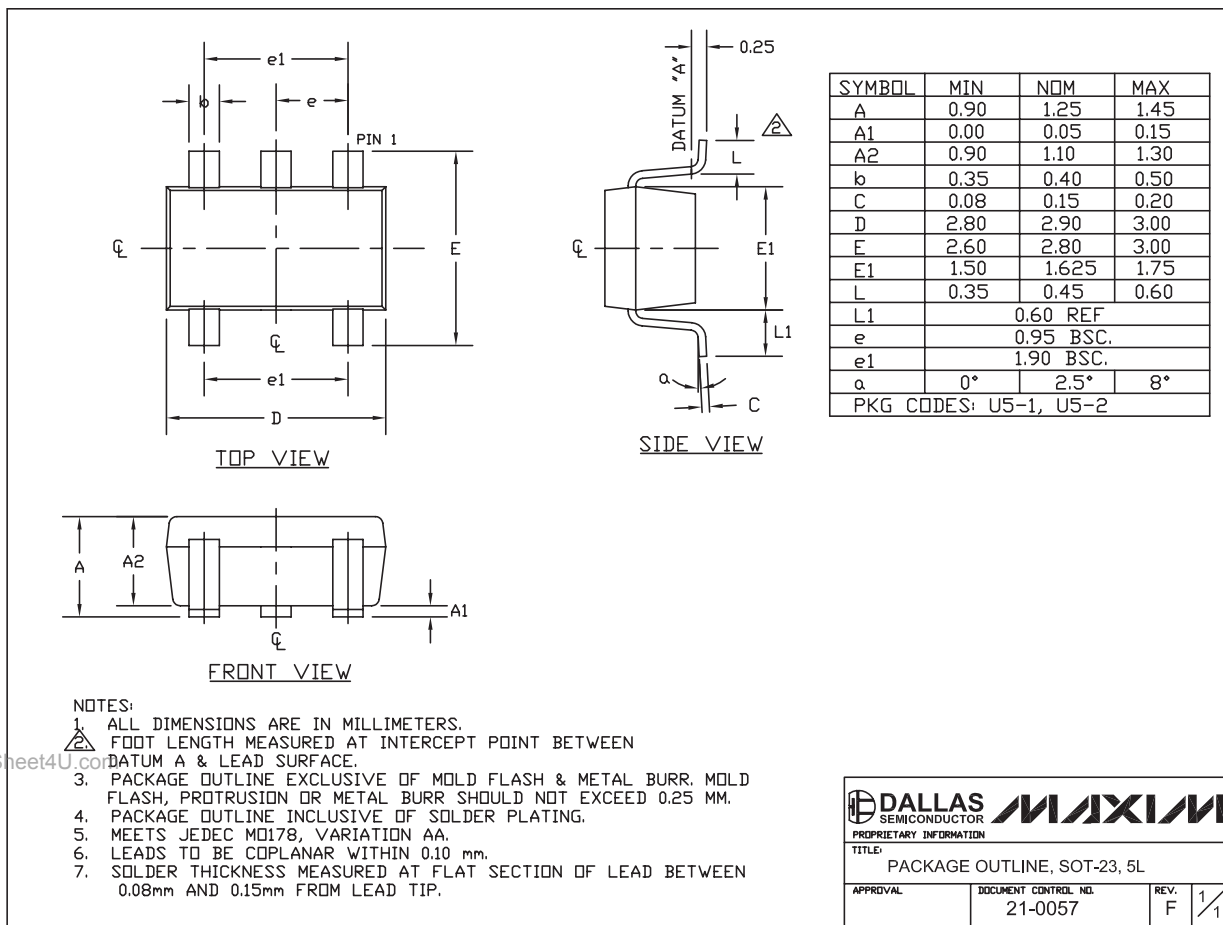

SOT-23 5L .EPS

Maxim cannot assume responsibility for use of any circuitry other than circuitry entirely embodied in a Maxim product. No circuit patent licenses are implied. Maxim reserves the right to change the circuitry and specifications without notice at any time.

10 Maxim Integrated Products, 120 San Gabriel Drive, Sunnyvale, CA 94086 408-737-7600