

GP1UD26XK Series/GP1UD27XK Series GP1UD28XK Series/GP1UD28YK Series

Energy Saving Type Low Dissipation Current IR Detecting Unit for Remote Control

■ Features

1. Low dissipation current: MAX.200 μ A (at $V_{CC}=3V$)
(1/12 of conventional type)
2. Wide operating voltage range (2.7 to 5.5V)
3. Various attachment shape

■ Applications

1. Audio video equipment
2. Home appliances

■ Outline Dimensions

(Unit : mm)

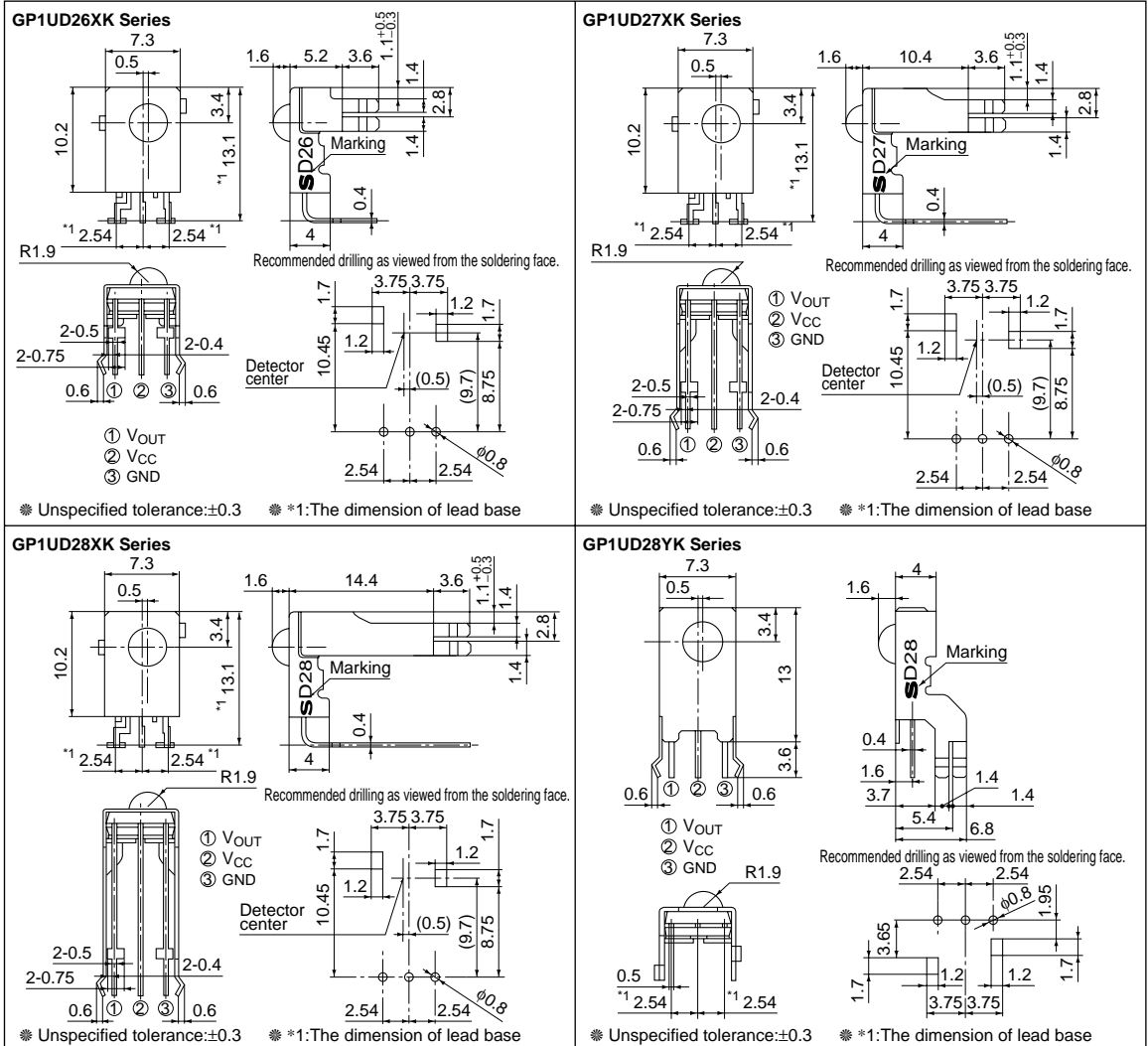

Absolute Maximum Ratings (Ta=25°C)

Parameter	Symbol	Rating	Unit
Supply voltage	V _{CC}	0 to +6.0	V
*1 Operating temperature	T _{opr}	-10 to +70	°C
Storage temperature	T _{stg}	-20 to +70	°C
*2 Soldering temperature	T _{sol}	260 (5s)	°C

*1 No dew condensation is allowed

*2 At mounting on PCB with thickness of 1.6mm

Recommended Operating Conditions

Parameter	Symbol	Operating conditions	Unit
Supply voltage	V _{CC}	2.7 to 5.5	V

Electro-optical Characteristics

(Unless otherwise specified, condition shall be Ta=25°C, V_{CC}=3V)

Parameter	Symbol	Conditions	MIN.	TYP.	MAX.	Unit
Dissipation current	I _{CC}	No input light	—	—	200	μA
High level output voltage	V _{OH}	*3	V _{CC} -0.5	—	—	V
Low level output voltage	V _{OL}	*3 I _{OL} =100μA	—	—	0.5	V
High level pulse width	T ₁	*3	700	—	1 200	μs
Low level pulse width	T ₂	*3	400	—	900	μs
B.P.F. center frequency	f _o	—	—	*4	—	kHz

*3 The burst wave as shown in the following figure shall be transmitted by the transmitter shown in Fig.2

The carrier frequency of the transmitter, however, shall be same as *4. Measuring shall be from just after starting the transmission until 50 pulse

*4 The B.P.F. center frequency f_o varies with model, as shown in **Model Line-ups**

Burst Wave

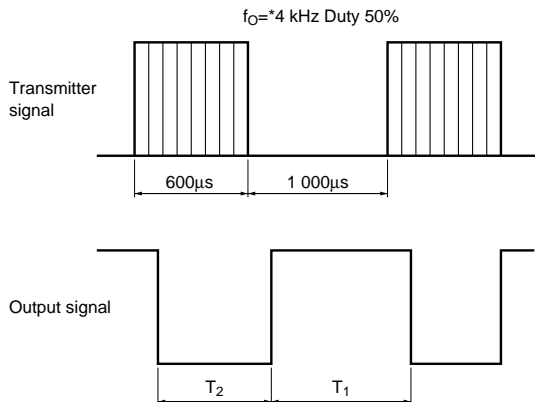

Model Line-up

B.P.F. center	Model No.			
40kHz	GP1UD26XK	GP1UD27XK	GP1UD28XK	GP1UD28YK
36kHz	GP1UD260XK	GP1UD270XK	GP1UD280XK	GP1UD280YK
38kHz	GP1UD261XK	GP1UD271XK	GP1UD281XK	GP1UD281YK
36.7kHz	GP1UD262XK	GP1UD272XK	GP1UD282XK	GP1UD282YK
32.75kHz	GP1UD263XK	GP1UD273XK	GP1UD283XK	GP1UD283YK
56.8kHz	GP1UD267XK	GP1UD277XK	GP1UD287XK	GP1UD287YK

Fig.1 Internal Block Diagram

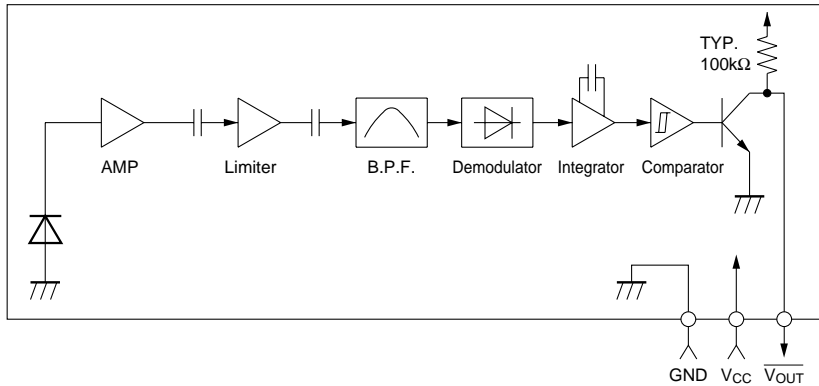

■ Performance

Using the transmitter shown in Fig.2, the output signal of the light detecting unit is good enough to meet the following items in the standard optical system in Fig.3.

1. Linear reception distance characteristics

When $L=0.2$ to 10.0m , $^{*5} E_V < 10 \text{ lx}$ and $\phi=0^\circ$ in Fig.3, the output signal shall meet the electrical characteristics in the attached list.

2. Sensitivity angle reception distance characteristics

When $L=0.2$ to 7.5m , $^{*5} E_V < 10 \text{ lx}$ and $\phi \leq 30^\circ$ in Fig.3, the output signal shall meet the electrical characteristics in the attached list.

3. Anti outer peripheral light reception distance characteristics

When $L=0.2$ to 5.0m , $^{*5,*6} E_V \leq 300 \text{ lx}$ and $\phi=0^\circ$ in Fig.3, the output signal shall meet the electrical characteristics in the attached list.

^{*5} It refers to detector face illuminance

^{*6} Outer peripheral light source: CIE standard light source A shall be used and placed at 45° from perpendicular axis at the detector face center

Fig.2 Transmitter

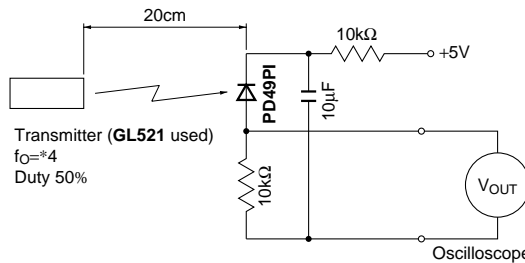

In the above figure, the transmitter should be set so that the output V_{OUT} (peak-to-peak) can be 40mV . However, the PD49PI to be used here should be of the short-circuit current $I_{SC}=2.6\mu\text{A}$ at $E_V=100 \text{ lx}$ (E_V is an illuminance by CIE standard light source A (tungsten lamp).)

Fig.3 Standard Optical System

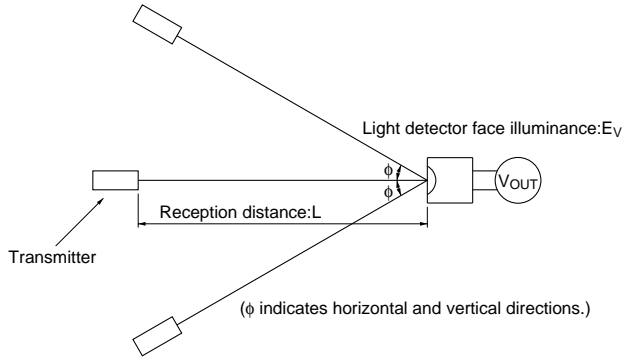

Fig.4 B.P.F.Frequency Characteristics (TYP.)

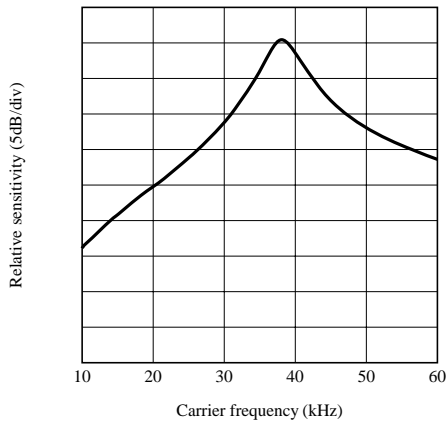

Fig.5 Sensitivity Angle (Horizontal Direction) Characteristics (TYP.) (Reference)

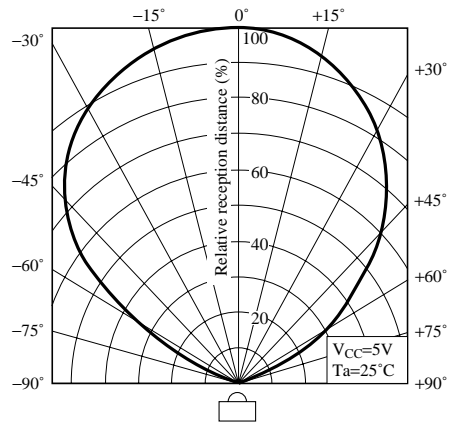

Fig.6 Sensitivity Angle (Vertical Direction) Characteristics (TYP.) (Reference)

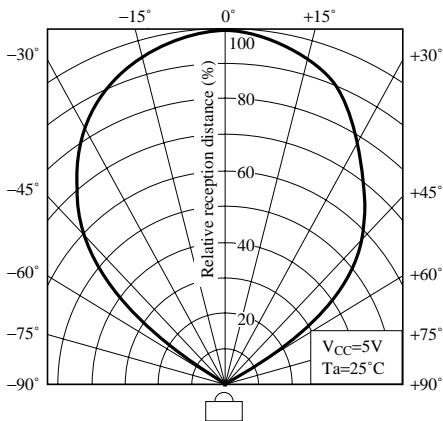

Fig.7 Relative Reception Distance vs. Ambient Temperature (TYP.) (Reference)

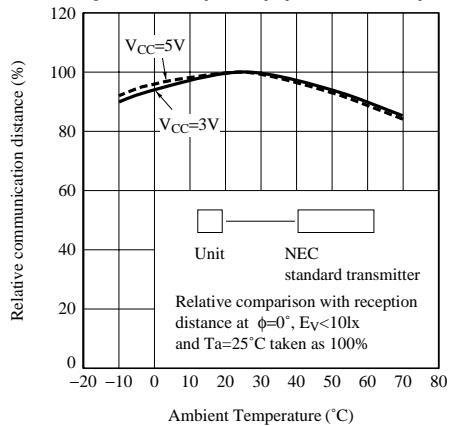

Fig.8 AEHA (Japan Association of Electrical Home Appliances) Code Pulse Width Characteristics (1st Bit) (TYP.) (Reference) ($V_{CC}=3V$)

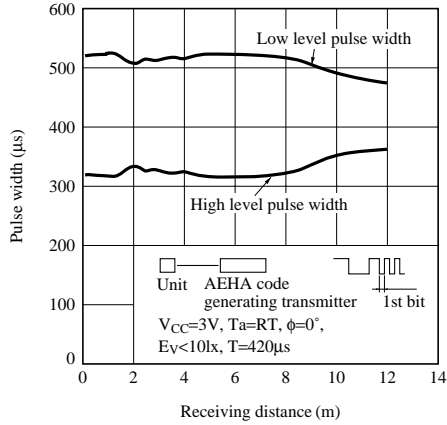

Fig.9 AEHA (Japan Association of Electrical Home Appliances) Code Pulse Width Characteristics (1st, Bit) (TYP.) (Reference) ($V_{CC}=5V$)

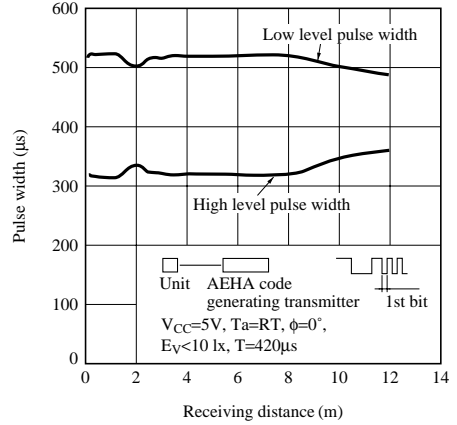

Fig.10 Dissipation Current vs. Supply Voltage

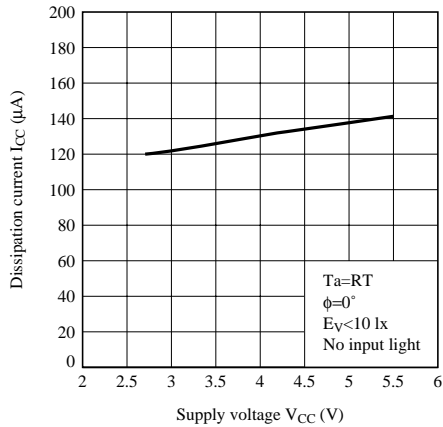
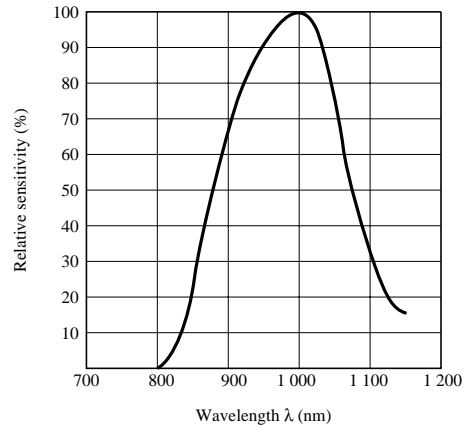
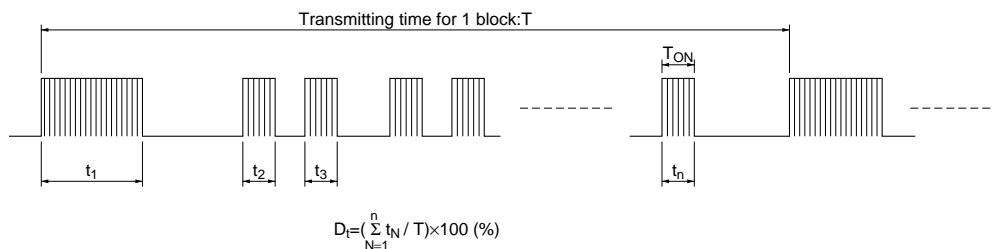

Fig.11 Spectral Sensitivity (Reference)



■ Precautions for Operation

- When this infrared remote control detecting unit shall be adopted for wireless remote control, please use it with the signal format of transmitter, which total duty ratio D_t (Emitting time $\sum_{N=1}^n t_N$ / Transmitting time for 1 block T) is 40% or less. ON signal time T_{ON} (Pulse width of the presence of modulated IR) should be 250 μ s or more. In case that the signal format of total duty and ON signal time is out of above conditions, there is a case that reception distance is much reduced or output is not appeared.



- Use the light emitting unit (remote control transmitter), in consideration of performance, characteristics, operating conditions of light emitting device and the characteristics of the light detecting unit.
- Pay attention to a malfunction of the light detecting unit when the surface is stained with dust and refuse.
Care must be taken not to touch the light detector surface.
If it should be dirty, wipe off such dust and refuse with soft cloth so as to prevent scratch. In case some solvents are required, use methyl alcohol, ethyl alcohol or isopropyl alcohol only.
Also, protect the light detecting unit against flux and others, since their deposition on the unit inside causes reduction of the function, fading of markings such as the part number.
- The shield case should be grounded on PCB pattern.
(The area across the shield case and the GND terminal is internally conductive in some cases and non-conductive in some other cases.)
- Do not apply unnecessary force to the terminal and the case.
- Do not push the light detector surface (photodiode) from outside.
- To avoid the electrostatic breakdown of IC, handle the unit under the condition of grounding with human body, soldering iron, etc.
- Do not use hole and groove set in the case of the light detecting unit for other purposes, since they are required to maintain the specified performance.
- External Circuit Examples (Mount the outer parts as near the unit as possible).

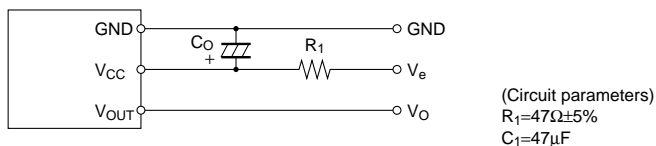

In setting R_1 and C_1 , use suitable values after considering under the real condition

- There is a possibility that noise on output may be caused by environmental condition (Disturbing light noise, Electromagnetic noise, Power supply line noise, etc.) even if there is no input transmission signal.
- Please shall confirm operation or your actual machine. Because the output pulse width of this product is fluctuated by environmental conditions such as signal format, temperature, distance from transmitter, and so on.

NOTICE

- The circuit application examples in this publication are provided to explain representative applications of SHARP devices and are not intended to guarantee any circuit design or license any intellectual property rights. SHARP takes no responsibility for any problems related to any intellectual property right of a third party resulting from the use of SHARP's devices.
- Contact SHARP in order to obtain the latest device specification sheets before using any SHARP device. SHARP reserves the right to make changes in the specifications, characteristics, data, materials, structure, and other contents described herein at any time without notice in order to improve design or reliability. Manufacturing locations are also subject to change without notice.
- Observe the following points when using any devices in this publication. SHARP takes no responsibility for damage caused by improper use of the devices which does not meet the conditions and absolute maximum ratings to be used specified in the relevant specification sheet nor meet the following conditions:
 - (i) The devices in this publication are designed for use in general electronic equipment designs such as:
 - Personal computers
 - Office automation equipment
 - Telecommunication equipment [terminal]
 - Test and measurement equipment
 - Industrial control
 - Audio visual equipment
 - Consumer electronics
 - (ii) Measures such as fail-safe function and redundant design should be taken to ensure reliability and safety when SHARP devices are used for or in connection with equipment that requires higher reliability such as:
 - Transportation control and safety equipment (i.e., aircraft, trains, automobiles, etc.)
 - Traffic signals
 - Gas leakage sensor breakers
 - Alarm equipment
 - Various safety devices, etc.
 - (iii) SHARP devices shall not be used for or in connection with equipment that requires an extremely high level of reliability and safety such as:
 - Space applications
 - Telecommunication equipment [trunk lines]
 - Nuclear power control equipment
 - Medical and other life support equipment (e.g., scuba).
- Contact a SHARP representative in advance when intending to use SHARP devices for any "specific" applications other than those recommended by SHARP or when it is unclear which category mentioned above controls the intended use.
- If the SHARP devices listed in this publication fall within the scope of strategic products described in the Foreign Exchange and Foreign Trade Control Law of Japan, it is necessary to obtain approval to export such SHARP devices.
- This publication is the proprietary product of SHARP and is copyrighted, with all rights reserved. Under the copyright laws, no part of this publication may be reproduced or transmitted in any form or by any means, electronic or mechanical, for any purpose, in whole or in part, without the express written permission of SHARP. Express written permission is also required before any use of this publication may be made by a third party.
- Contact and consult with a SHARP representative if there are any questions about the contents of this publication.