



BYT230PIV-1000 BYT231PIV-1000

FAST RECOVERY RECTIFIER DIODES

MAIN PRODUCT CHARACTERISTICS

$I_{F(AV)}$	2 x 30 A
V_{RRM}	1000 V
$V_F(max)$	1.8 V
$t_{rr}(max)$	80 ns

FEATURES AND BENEFITS

- VERY LOW REVERSE RECOVERY TIME
- VERY LOW SWITCHING LOSSES
- LOW NOISE TURN-OFF SWITCHING
- INSULATED PACKAGE: ISOTOP
 Insulation voltage: 2500 V_{RMS}
 Capacitance = 45 pF
 Inductance < 5 nH

DESCRIPTION

Dual high voltage rectifier devices are suited for free-wheeling function in converters and motor control circuits.

Packaged in ISOTOP, they are intended for use in Switch Mode Power Supplies.

ABSOLUTE RATINGS (limiting values, per diode)

Symbol	Parameter		Value	Unit
V_{RRM}	Repetitive peak reverse voltage		1000	V
I_{FRM}	Repetitive peak forward current	$t_p=5\mu s$ $F=1kHz$	700	A
$I_{F(RMS)}$	RMS forward current		50	A
$I_{F(AV)}$	Average forward current	$T_c = 55^\circ C$ $\delta = 0.5$	30	A
I_{FSM}	Surge non repetitive forward current	$t_p = 10 ms$ Sinusoidal	200	A
T_{stg}	Storage temperature range		- 40 to + 150	°C
T_j	Maximum operating junction temperature		150	°C

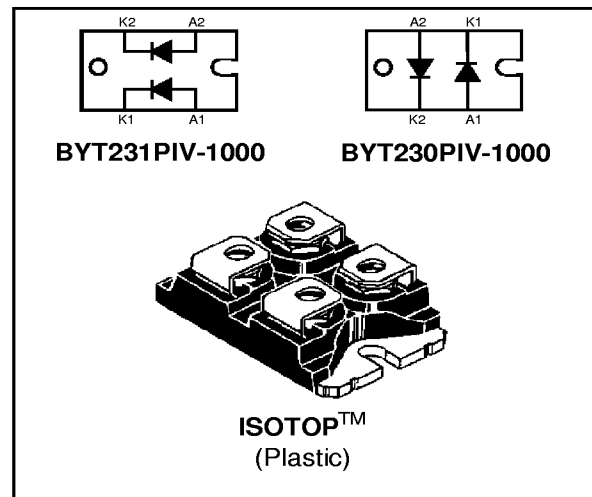

TM: ISOTOP is a registered trademark of STMicroelectronics.

BYT230PIV-1000 / BYT231PIV-1000

THERMAL RESISTANCES

Symbol	Parameter		Value	Unit
$R_{th(j-c)}$	Junction to case	Per diode	1.5	°C/W
		Total	0.8	
$R_{th(c)}$		Coupling	0.1	

When the diodes 1 and 2 are used simultaneously :

$$\Delta T_j(\text{diode 1}) = P(\text{diode}) \times R_{th(j-c)} (\text{Per diode}) + P(\text{diode 2}) \times R_{th(c)}$$

STATIC ELECTRICAL CHARACTERISTICS (per diode)

Symbol	Parameter	Test Conditions		Min.	Typ.	Max.	Unit
V_F^*	Forward voltage drop	$T_j = 25^\circ\text{C}$	$I_F = 30\text{ A}$			1.9	V
		$T_j = 100^\circ\text{C}$				1.8	
I_R^{**}	Reverse leakage current	$T_j = 25^\circ\text{C}$	$V_R = V_{RRM}$			100	μA
		$T_j = 100^\circ\text{C}$				5	mA

Pulse test : * $t_p = 380\ \mu\text{s}$, $\delta < 2\%$

** $t_p = 5\ \text{ms}$, $\delta < 2\%$

To evaluate the conduction losses use the following equation:

$$P = 1.47 \times I_{F(AV)} + 0.010 I_{F(RMS)}^2$$

RECOVERY CHARACTERISTICS (per diode)

Symbol	Test Conditions		Min.	Typ.	Max.	Unit
t_{rr}	$T_j = 25^\circ\text{C}$	$I_F = 1\text{ A}$ $V_R = 30\text{ V}$ $dI_F/dt = -15\text{ A}/\mu\text{s}$			165	ns
		$I_F = 0.5\text{ A}$ $I_R = 1\text{ A}$ $I_{rr} = 0.25\text{ A}$			80	

TURN-OFF SWITCHING CHARACTERISTICS (per diode)

Symbol	Parameter	Test Conditions		Min.	Typ.	Max.	Unit
t_{IRM}	Maximum reverse recovery time	$dI_F/dt = -120\ \text{A}/\mu\text{s}$	$V_{CC} = 200\ \text{V}$ $I_F = 30\ \text{A}$ $L_p \leq 0.05\ \mu\text{H}$ $T_j = 100^\circ\text{C}$ (see fig. 11)			200	ns
		$dI_F/dt = -240\ \text{A}/\mu\text{s}$				120	
I_{RM}	Maximum reverse recovery current	$dI_F/dt = -120\ \text{A}/\mu\text{s}$	$V_{CC} = 200\ \text{V}$ $I_F = I_{F(AV)}$ $L_p = 5\ \mu\text{H}$ (see fig. 12)			19.5	A
		$dI_F/dt = -240\ \text{A}/\mu\text{s}$				22	
$C = \frac{V_{RP}}{V_{CC}}$	Turn-off overvoltage coefficient	$T_j = 100^\circ\text{C}$ $V_{CC} = 200\text{V}$ $I_F = I_{F(AV)}$ $dI_F/dt = -30\text{A}/\mu\text{s}$ $L_p = 5\mu\text{H}$ (see fig. 12)				4.5	/

Fig. 1: Low frequency power losses versus average current.

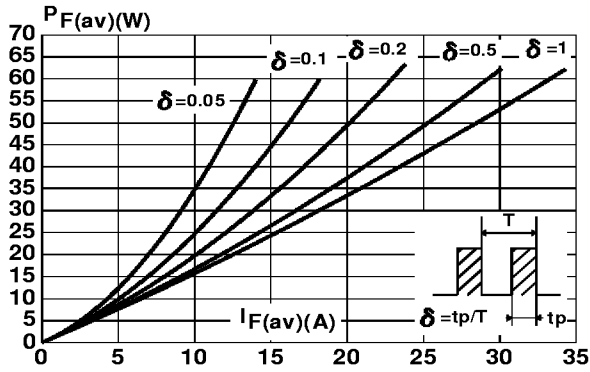

Fig. 2: Peak current versus form factor.

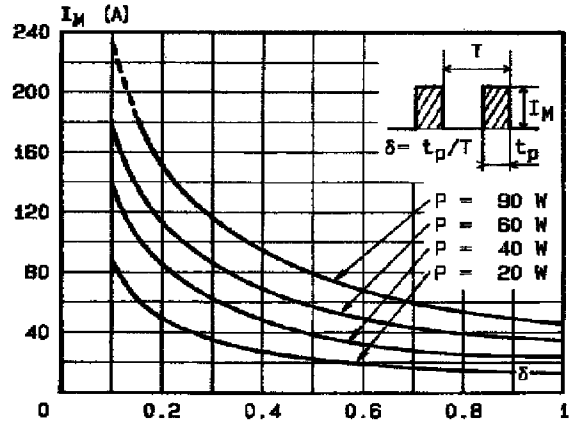

Fig. 3: Non repetitive peak surge current versus overload duration.

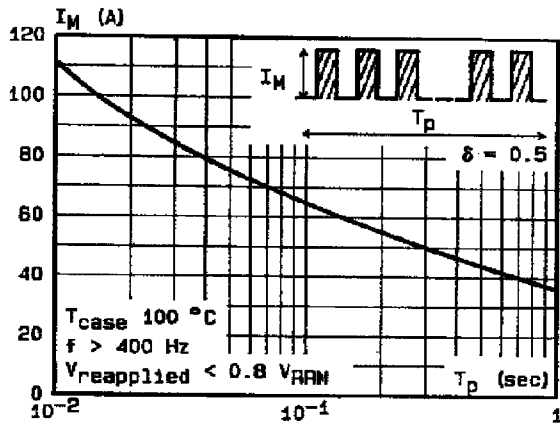

Fig. 4: Relative variation of thermal impedance junction to case versus pulse duration.

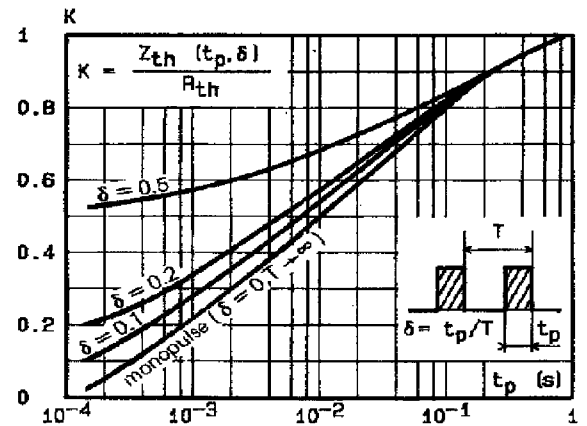

Fig. 5: Voltage drop versus forward current.

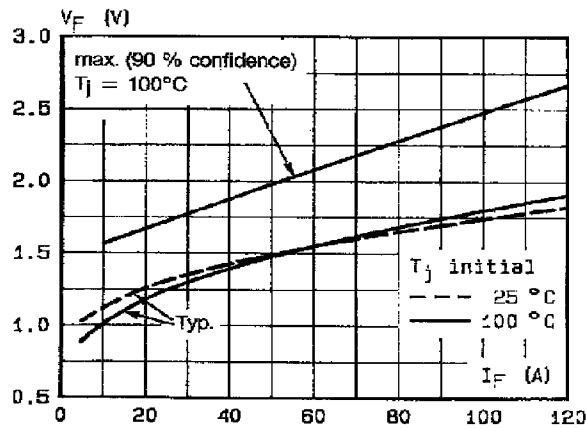

Fig. 6: Recovery charge versus di/dt.

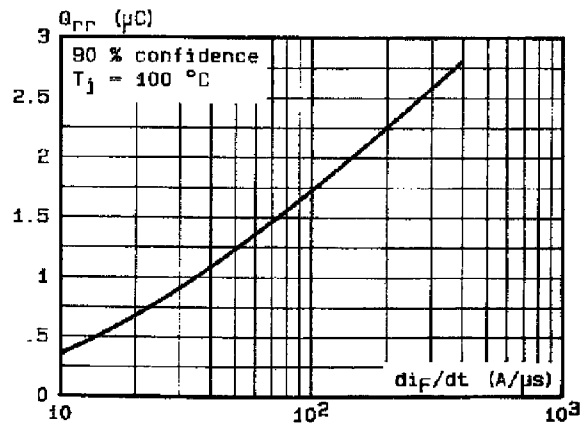

Fig. 7: Recovery time versus di_F/dt .

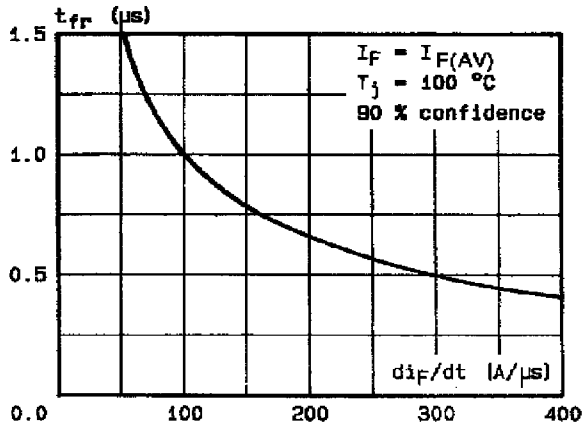

Fig. 9: Peak forward voltage versus di_F/dt .

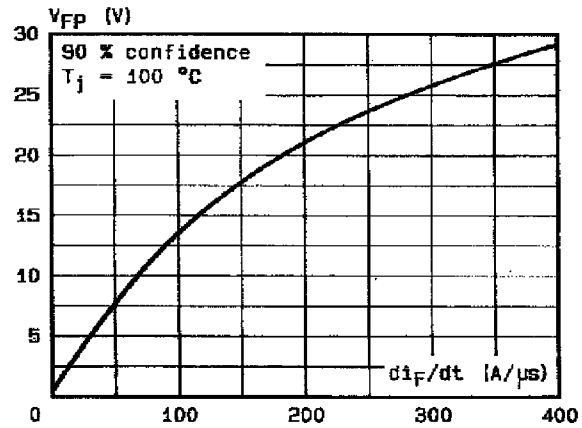

Fig. 11: Turn-off switching characteristics (without series inductance).

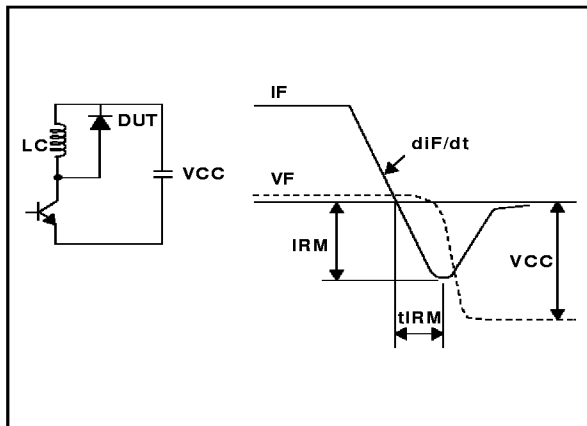

Fig. 8: Peak reverse current versus di_F/dt .

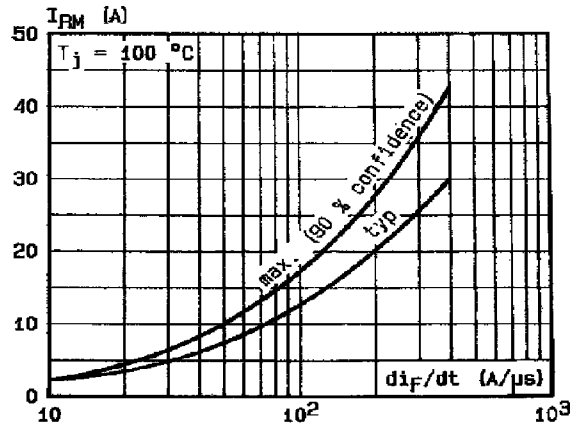

Fig. 10: Dynamic parameters versus junction temperature.

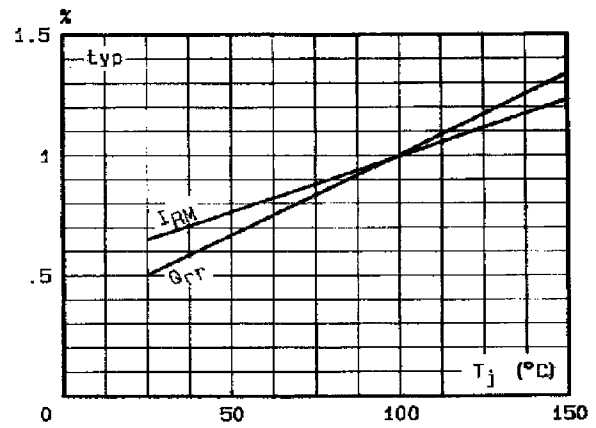
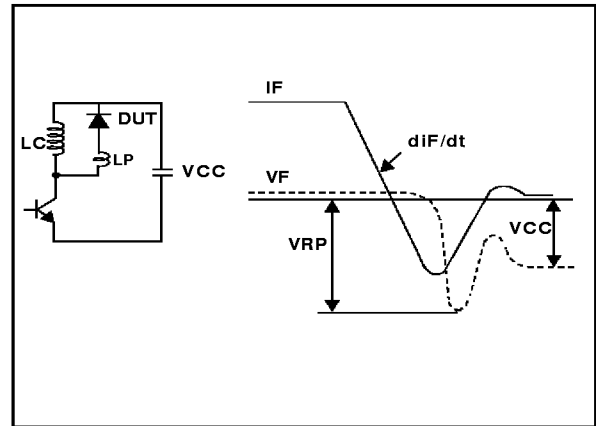
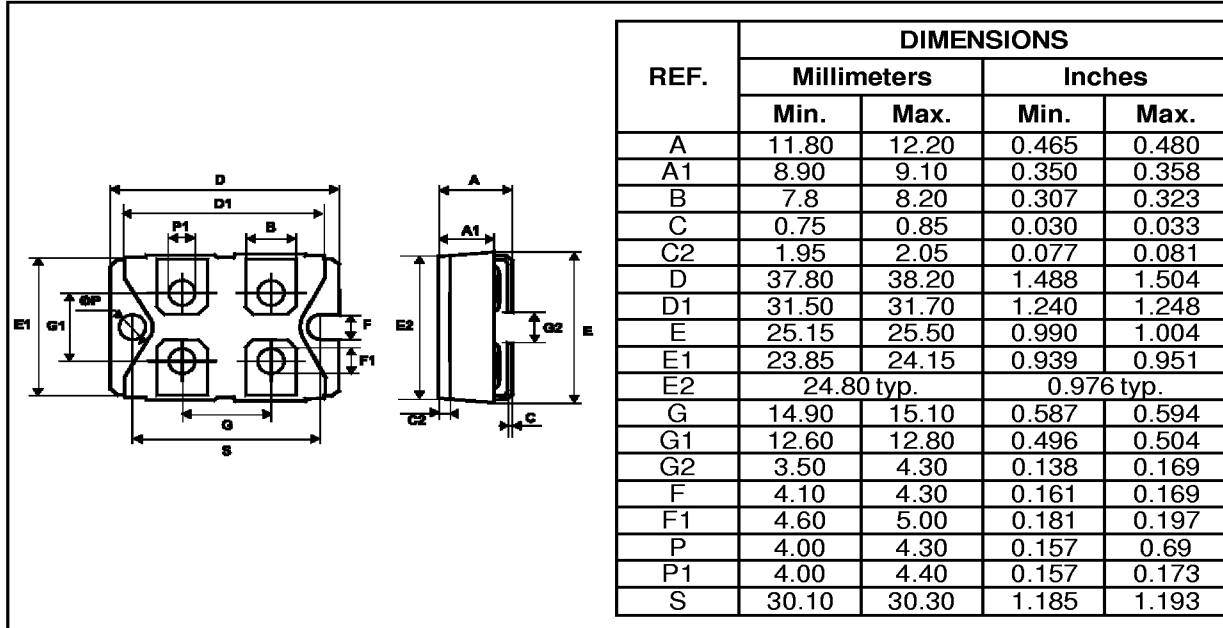

Fig. 12: Turn-off switching characteristics (with series inductance).



PACKAGE MECHANICAL DATA
ISOTOP



Ordering type	Marking	Package	Weight	Base qty	Delivery mode
BYT230PIV-1000	BYT230PIV-1000	ISOTOP	28 g. (without screws)	10	Tube
BYT231PIV-1000	BYT231PIV-1000	ISOTOP	28 g. (without screws)	10	Tube

- Cooling method: by conduction (C)
- Recommended torque value : 1.3 N.m (MAX 1.5 N.m) for the 6 x M4 screws. (2 x M4 screws recommended for mounting the package on the heatsink and the 4 screws given with the screw version). The screws supplied with the package are adapted for mounting on a board (or other types of terminals) with a thickness of 0.6 mm min and 2.2 mm max.
- Epoxy meets UL94,V0

Information furnished is believed to be accurate and reliable. However, STMicroelectronics assumes no responsibility for the consequences of use of such information nor for any infringement of patents or other rights of third parties which may result from its use. No license is granted by implication or otherwise under any patent or patent rights of STMicroelectronics. Specifications mentioned in this publication are subject to change without notice. This publication supersedes and replaces all information previously supplied. STMicroelectronics products are not authorized for use as critical components in life support devices or systems without express written approval of STMicroelectronics.

The ST logo is a registered trademark of STMicroelectronics
 © 1999 STMicroelectronics - Printed in Italy - All rights reserved.
 STMicroelectronics GROUP OF COMPANIES
 Australia - Brazil - China - Finland - France - Germany - Hong Kong - India - Italy - Japan - Malaysia
 Malta - Morocco - Singapore - Spain - Sweden - Switzerland - United Kingdom - U.S.A.
<http://www.st.com>

