



Zero-Drift, Single-Supply Rail-to-Rail Input/Output Operational Amplifier

AD8628

FEATURES

- Lowest Auto-Zero Amplifier Noise
- Low Offset Voltage: $1\ \mu\text{V}$
- Input Offset Drift: $0.02\ \mu\text{V}/^\circ\text{C}$
- Rail-to-Rail Input and Output Swing
- 5 V Single-Supply Operation
- High Gain, CMRR, and PSRR: 120 dB
- Very Low Input Bias Current: 100 pA
- Low Supply Current: 1.0 mA
- Overload Recovery Time: 10 μs
- No External Components Required

APPLICATIONS

- Automotive Sensors
- Pressure and Position Sensors
- Strain Gage Amplifiers
- Medical Instrumentation
- Thermocouple Amplifiers
- Precision Current Sensing
- Photodiode Amplifier

GENERAL DESCRIPTION

This new breed of amplifier has ultralow offset, drift, and bias current. The AD8628 is a wide bandwidth auto-zero amplifier featuring rail-to-rail input and output swings and low noise. Operation is fully specified from 2.7 V to 5 V single supply ($\pm 1.35\ \text{V}$ to $\pm 2.5\ \text{V}$ dual supply).

The AD8628 family provides benefits previously found only in expensive auto-zeroing or chopper-stabilized amplifiers. Using Analog Devices' new topology, these zero-drift amplifiers combine low cost with high accuracy and low noise. (No external capacitors are required.) In addition, the AD8628 greatly reduces the digital switching noise found in most chopper-stabilized amplifiers.

With an offset voltage of only $1\ \mu\text{V}$, drift less than $0.005\ \mu\text{V}/^\circ\text{C}$, and noise of only $0.5\ \mu\text{V}$ p-p (0 Hz to 10 Hz), the AD8628 is perfectly suited for applications where error sources cannot be tolerated. Position and pressure sensors, medical equipment, and strain gage amplifiers benefit greatly from nearly zero drift over their operating temperature range. Many systems can take advantage of the rail-to-rail input and output swings provided by the AD8628 family to reduce input biasing complexity and maximize SNR.

The AD8628 family is specified for the extended industrial temperature range (-40°C to $+125^\circ\text{C}$). The AD8628 amplifier is available in the tiny SOT-23 and the popular 8-lead narrow SOIC plastic packages. The SOT-23 package devices are available only in tape and reel.

REV. 0

Information furnished by Analog Devices is believed to be accurate and reliable. However, no responsibility is assumed by Analog Devices for its use, nor for any infringements of patents or other rights of third parties that may result from its use. No license is granted by implication or otherwise under any patent or patent rights of Analog Devices.

PIN CONFIGURATIONS

5-Lead SOT-23 (RT Suffix)

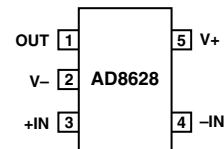

8-Lead SOIC (R Suffix)

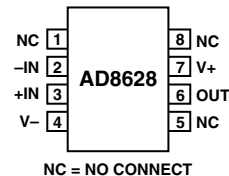

AD8628—SPECIFICATIONS

ELECTRICAL CHARACTERISTICS ($V_S = 5.0\text{ V}$, $V_{CM} = 2.5\text{ V}$, $T_A = 25^\circ\text{C}$, unless otherwise noted.)

Parameter	Symbol	Conditions	Min	Typ	Max	Unit
INPUT CHARACTERISTICS						
Offset Voltage	V_{OS}	$-40^\circ\text{C} \leq T_A \leq +125^\circ\text{C}$		1	5	μV
Input Bias Current	I_B	$-40^\circ\text{C} \leq T_A \leq +125^\circ\text{C}$		30	100	pA
Input Offset Current	I_{OS}	$-40^\circ\text{C} \leq T_A \leq +125^\circ\text{C}$		50	200	pA
Input Voltage Range			0		5	V
Common-Mode Rejection Ratio	CMRR	$V_{CM} = 0\text{ V to } 5\text{ V}$ $-40^\circ\text{C} \leq T_A \leq +125^\circ\text{C}$	120	140		dB
Large Signal Voltage Gain*	A_{VO}	$R_L = 10\text{ k}\Omega$, $V_O = 0.3\text{ V to } 4.7\text{ V}$ $-40^\circ\text{C} \leq T_A \leq +125^\circ\text{C}$	115	130		dB
Offset Voltage Drift	$\Delta V_{OS}/\Delta T$	$-40^\circ\text{C} \leq T_A \leq +125^\circ\text{C}$		0.002	0.02	$\mu\text{V}/^\circ\text{C}$
OUTPUT CHARACTERISTICS						
Output Voltage High	V_{OH}	$R_L = 100\text{ k}\Omega$ to Ground $-40^\circ\text{C} \leq T_A \leq +125^\circ\text{C}$	4.99	4.996		V
		$R_L = 10\text{ k}\Omega$ to Ground $-40^\circ\text{C} \leq T_A \leq +125^\circ\text{C}$	4.99	4.995		V
		$R_L = 10\text{ k}\Omega$ to Ground $-40^\circ\text{C} \leq T_A \leq +125^\circ\text{C}$	4.95	4.98		V
		$R_L = 10\text{ k}\Omega$ to Ground $-40^\circ\text{C} \leq T_A \leq +125^\circ\text{C}$	4.95	4.97		V
Output Voltage Low	V_{OL}	$R_L = 100\text{ k}\Omega$ to V+ $-40^\circ\text{C} \leq T_A \leq +125^\circ\text{C}$		1	5	mV
		$R_L = 10\text{ k}\Omega$ to V+ $-40^\circ\text{C} \leq T_A \leq +125^\circ\text{C}$		2	5	mV
		$R_L = 10\text{ k}\Omega$ to V+ $-40^\circ\text{C} \leq T_A \leq +125^\circ\text{C}$		10	20	mV
		$R_L = 10\text{ k}\Omega$ to V+ $-40^\circ\text{C} \leq T_A \leq +125^\circ\text{C}$		15	20	mV
Short Circuit Limit	I_{SC}	$-40^\circ\text{C} \leq T_A \leq +125^\circ\text{C}$	± 25	± 50		mA
Output Current	I_O	$-40^\circ\text{C} \leq T_A \leq +125^\circ\text{C}$		± 40		mA
		$-40^\circ\text{C} \leq T_A \leq +125^\circ\text{C}$		± 30		mA
		$-40^\circ\text{C} \leq T_A \leq +125^\circ\text{C}$		± 15		mA
POWER SUPPLY						
Power Supply Rejection Ratio	PSRR	$V_S = 2.7\text{ V to } 5.5\text{ V}$ $-40^\circ\text{C} \leq T_A \leq +125^\circ\text{C}$	115	130		dB
Supply Current/Amplifier	I_{SY}	$V_O = 0\text{ V}$ $-40^\circ\text{C} \leq T_A \leq +125^\circ\text{C}$		0.85	1.1	mA
				1.0	1.2	mA
INPUT CAPACITANCE						
Differential	C_{IN}			1.5		pF
Common Mode				10		pF
DYNAMIC PERFORMANCE						
Slew Rate	SR	$R_L = 10\text{ k}\Omega$		1.0		$\text{V}/\mu\text{s}$
Overload Recovery Time				0.05		ms
Gain Bandwidth Product	GBP			2.5		MHz
NOISE PERFORMANCE						
Voltage Noise	e_n p-p	0.1 Hz to 10 Hz		0.5		$\mu\text{V p-p}$
	e_n p-p	0.1 Hz to 1.0 Hz		0.16		$\mu\text{V p-p}$
Voltage Noise Density	e_n	$f = 1\text{ kHz}$		22		$\text{nV}/\sqrt{\text{Hz}}$
Current Noise Density	i_n	$f = 10\text{ Hz}$		5		$\text{fA}/\sqrt{\text{Hz}}$

*Gain testing is highly dependent upon test bandwidth.

Specifications subject to change without notice.

ELECTRICAL CHARACTERISTICS ($V_S = 2.7\text{ V}$, $V_{CM} = 1.35\text{ V}$, $V_O = 1.4\text{ V}$, $T_A = 25^\circ\text{C}$, unless otherwise noted.)

Parameter	Symbol	Conditions	Min	Typ	Max	Unit	
INPUT CHARACTERISTICS							
Offset Voltage	V_{OS}	$-40^\circ\text{C} \leq T_A \leq +125^\circ\text{C}$		1	5	μV	
Input Bias Current	I_B	$-40^\circ\text{C} \leq T_A \leq +125^\circ\text{C}$		30	100	pA	
Input Offset Current	I_{OS}	$-40^\circ\text{C} \leq T_A \leq +125^\circ\text{C}$		1.0	1.5	nA	
Input Voltage Range		$-40^\circ\text{C} \leq T_A \leq +125^\circ\text{C}$		50	200	pA	
Common-Mode Rejection Ratio	CMRR	$V_{CM} = 0\text{ V to } 2.9\text{ V}$ $-40^\circ\text{C} \leq T_A \leq +125^\circ\text{C}$	0	115	130	5	dB
Large Signal Voltage Gain	A_{VO}	$R_L = 10\text{ k}\Omega$, $V_O = 0.3\text{ V to } 4.7\text{ V}$ $-40^\circ\text{C} \leq T_A \leq +125^\circ\text{C}$	110	110	120		dB
Offset Voltage Drift	$\Delta V_{OS}/\Delta T$	$-40^\circ\text{C} \leq T_A \leq +125^\circ\text{C}$	105	130			dB
				0.002	0.02		$\mu\text{V}/^\circ\text{C}$
OUTPUT CHARACTERISTICS							
Output Voltage High	V_{OH}	$R_L = 100\text{ k}\Omega$ to Ground $-40^\circ\text{C} \leq T_A \leq +125^\circ\text{C}$	2.68	2.68	2.695		V
		$R_L = 10\text{ k}\Omega$ to Ground $-40^\circ\text{C} \leq T_A \leq +125^\circ\text{C}$	2.67	2.67	2.68		V
Output Voltage Low	V_{OL}	$R_L = 100\text{ k}\Omega$ to V+ $-40^\circ\text{C} \leq T_A \leq +125^\circ\text{C}$	2.67	2.67	2.675		V
		$R_L = 10\text{ k}\Omega$ to V+ $-40^\circ\text{C} \leq T_A \leq +125^\circ\text{C}$		1	5		mV
Short Circuit Limit	I_{SC}	$-40^\circ\text{C} \leq T_A \leq +125^\circ\text{C}$		2	5		mV
				10	20		mV
Output Current	I_O	$-40^\circ\text{C} \leq T_A \leq +125^\circ\text{C}$		15	20		mV
			± 10	± 15			mA
				± 10			mA
				± 10			mA
				± 5			mA
POWER SUPPLY							
Power Supply Rejection Ratio	PSRR	$V_S = 2.7\text{ V to } 5.5\text{ V}$ $-40^\circ\text{C} \leq T_A \leq +125^\circ\text{C}$	115	130			dB
Supply Current/Amplifier	I_{SY}	$V_O = 0\text{ V}$ $-40^\circ\text{C} \leq T_A \leq +125^\circ\text{C}$		0.75	1.0		mA
				0.9	1.1		mA
INPUT CAPACITANCE							
Differential	C_{IN}			1.5			pF
Common Mode				10			pF
DYNAMIC PERFORMANCE							
Slew Rate	SR	$R_L = 10\text{ k}\Omega$		1			V/ μs
Overload Recovery Time				0.05			ms
Gain Bandwidth Product	GBP			2			MHz
NOISE PERFORMANCE							
Voltage Noise	e_n p-p	0.1 Hz to 10 Hz		0.5			$\mu\text{V p-p}$
Voltage Noise Density	e_n	$f = 1\text{ kHz}$		22			$\text{nV}/\sqrt{\text{Hz}}$
Current Noise Density	i_n	$f = 10\text{ Hz}$		5			$\text{fA}/\sqrt{\text{Hz}}$

Specifications subject to change without notice.

AD8628

ABSOLUTE MAXIMUM RATINGS¹

Supply Voltage	6 V
Input Voltage	GND – 0.3 V to V_{S-} + 0.3 V
Differential Input Voltage ²	± 5.0 V
Output Short-Circuit Duration to GND	Indefinite
Storage Temperature Range	
R, RT Packages	–65°C to +150°C
Operating Temperature Range	–40°C to +125°C
Junction Temperature Range	
R, RT Packages	–65°C to +150°C
Lead Temperature Range (Soldering, 60 sec)	300°C

¹Stresses above those listed under Absolute Maximum Ratings may cause permanent damage to the device. This is a stress rating only; functional operation of the device at these or any other conditions above those listed in the operational sections of this specification is not implied. Exposure to absolute maximum rating conditions for extended periods may affect device reliability.

²Differential input voltage is limited to ± 5 V or the supply voltage, whichever is less.

Package Type	θ_{JA} *	θ_{JC}	Unit
5-Lead SOT-23 (RT)	230	146	°C/W
8-Lead SOIC (R)	158	43	°C/W

* θ_{JA} is specified for worst-case conditions, i.e., θ_{JA} is specified for device soldered in circuit board for surface-mount packages.

ORDERING GUIDE

Model	Temperature Range	Package Description	Package Option	Branding Information
AD8628ART	–40°C to +125°C	5-Lead SOT-23	RT-5	AYA
AD8628AR	–40°C to +125°C	8-Lead SOIC	R-8	

CAUTION

ESD (electrostatic discharge) sensitive device. Electrostatic charges as high as 4000 V readily accumulate on the human body and test equipment and can discharge without detection. Although the AD8628 features proprietary ESD protection circuitry, permanent damage may occur on devices subjected to high energy electrostatic discharges. Therefore, proper ESD precautions are recommended to avoid performance degradation or loss of functionality.



Typical Performance Characteristics—AD8628

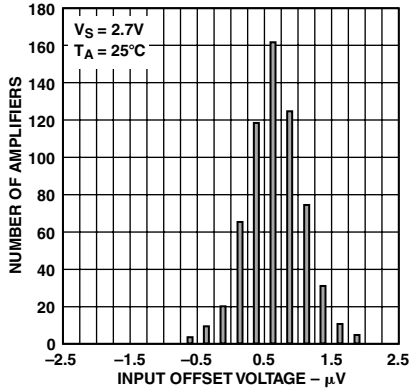

TPC 1. Input Offset Voltage Distribution at 2.7 V

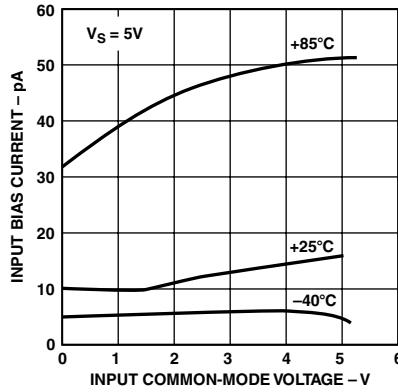

TPC 2. Input Bias Current vs. Input Common-Mode Voltage at 5 V

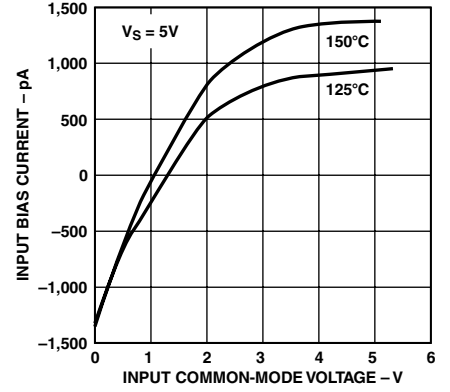

TPC 3. Input Bias Current vs. Input Common-Mode Voltage at 5 V

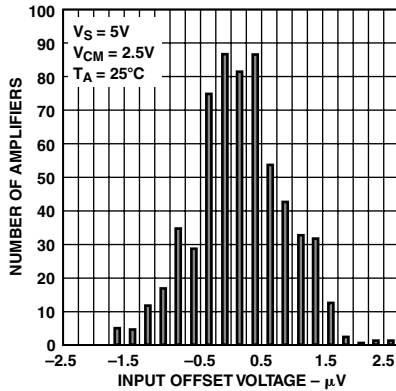

TPC 4. Input Offset Voltage Distribution at 5 V

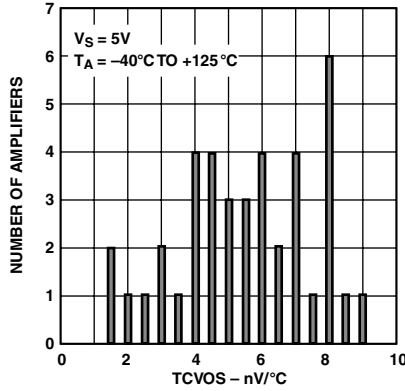

TPC 5. Input Offset Voltage Drift

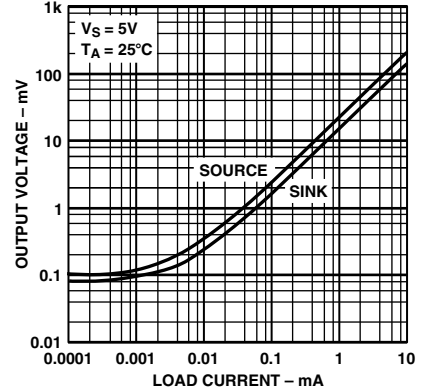

TPC 6. Output Voltage to Supply Rail vs. Load Current at 5 V

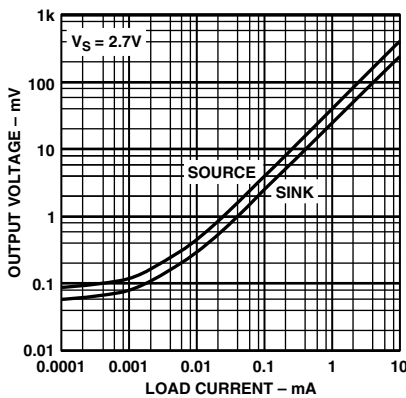

TPC 7. Output Voltage to Supply Rail vs. Load Current at 2.7 V

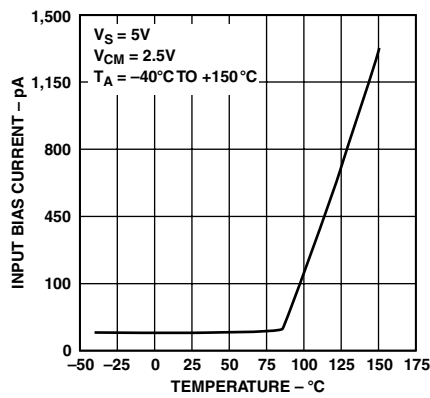

TPC 8. Input Bias Current vs. Temperature

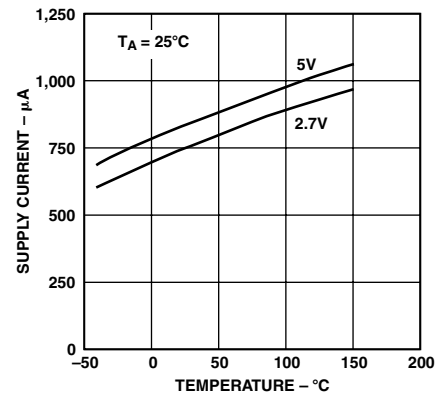

TPC 9. Supply Current vs. Temperature

AD8628

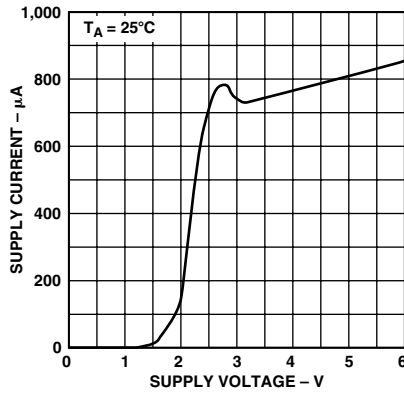

TPC 10. Supply Current vs. Supply Voltage

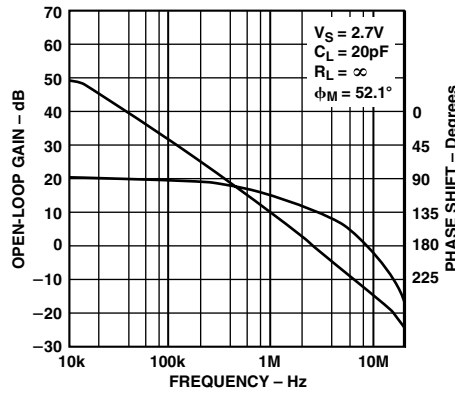

TPC 11. Open-Loop Gain and Phase vs. Frequency

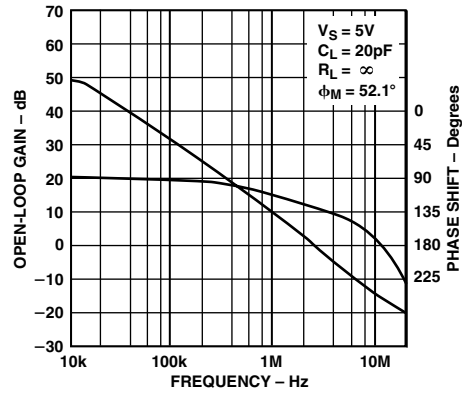

TPC 12. Open-Loop Gain and Phase vs. Frequency

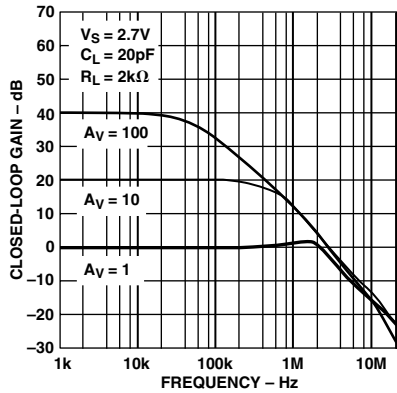

TPC 13. Closed-Loop Gain vs. Frequency at 2.7 V

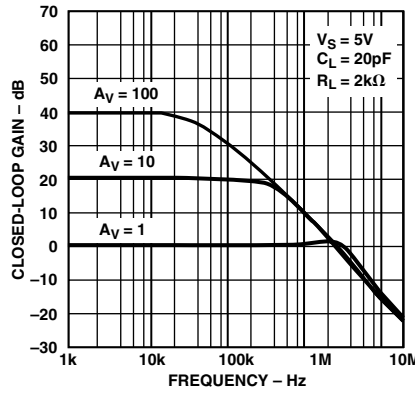

TPC 14. Closed-Loop Gain vs. Frequency at 5 V

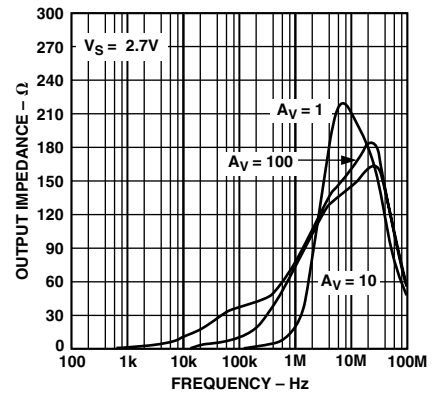

TPC 15. Output Impedance vs. Frequency at 2.7 V

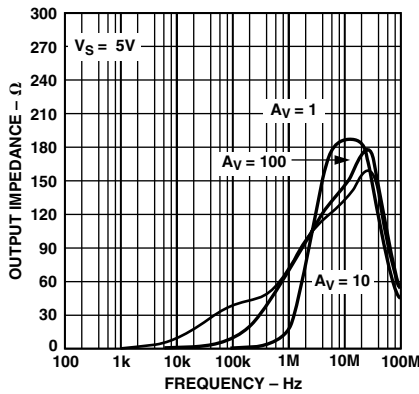

TPC 16. Output Impedance vs. Frequency at 5 V

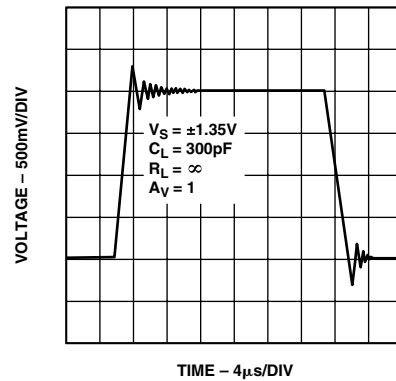

TPC 17. Large Signal Transient Response at 2.7 V

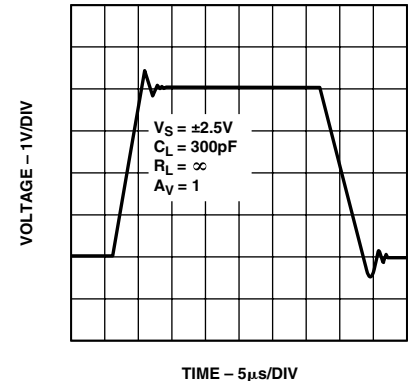

TPC 18. Large Signal Transient Response at 5 V

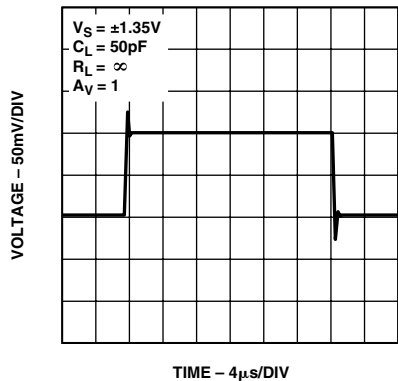

TPC 19. Small Signal Transient Response at 2.7 V

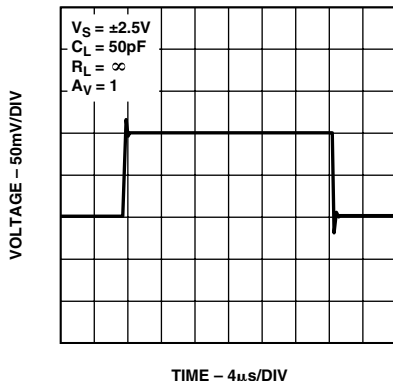

TPC 20. Small Signal Transient Response at 5 V

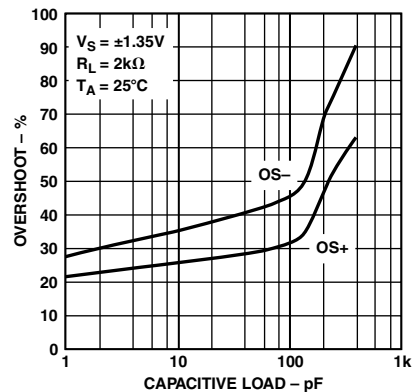

TPC 21. Small Signal Overshoot vs. Load Capacitance at 2.7 V

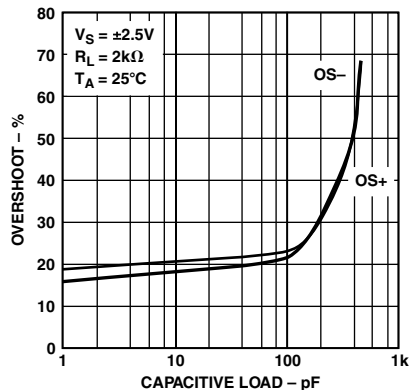

TPC 22. Small Signal Overshoot vs. Load Capacitance at 5 V

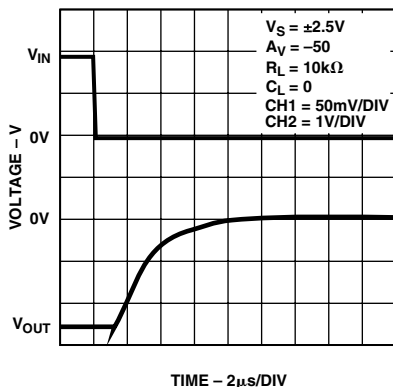

TPC 23. Positive Overvoltage Recovery

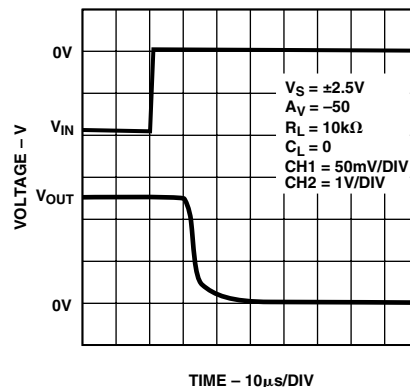

TPC 24. Negative Overvoltage Recovery

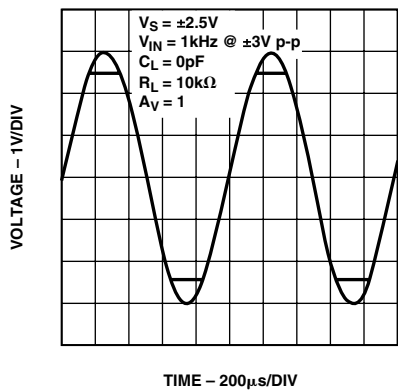

TPC 25. No Phase Reversal

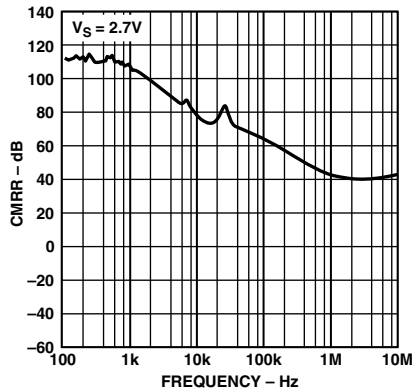

TPC 26. CMRR vs. Frequency at 2.7 V

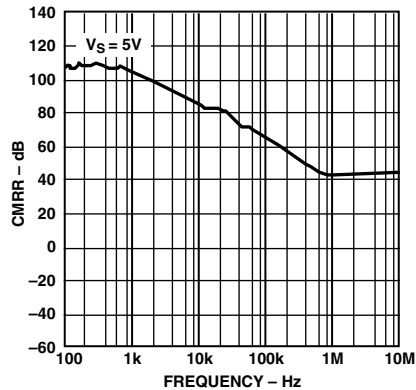

TPC 27. CMRR vs. Frequency at 5 V

AD8628

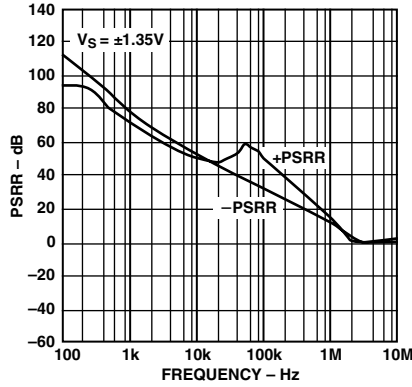

TPC 28. PSRR vs. Frequency

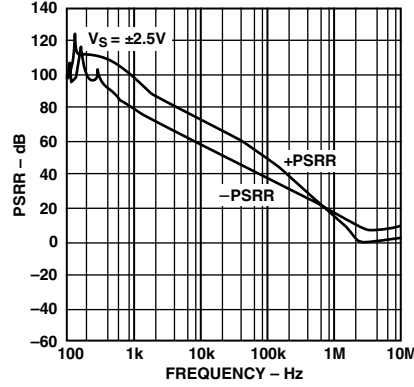

TPC 29. PSRR vs. Frequency

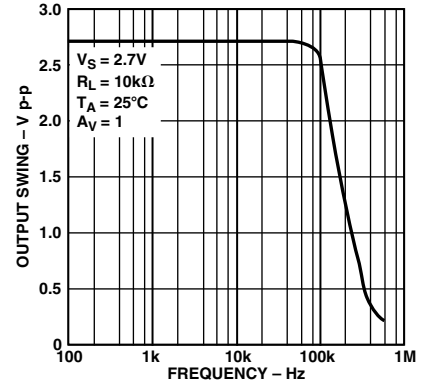

TPC 30. Maximum Output Swing vs. Frequency

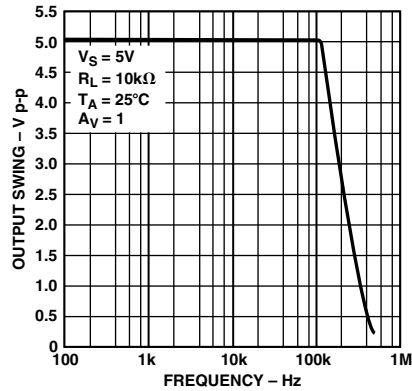

TPC 31. Maximum Output Swing vs. Frequency at 5 V

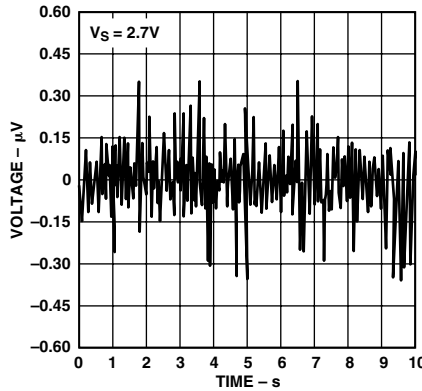

TPC 32. 0.1 Hz to 10 Hz Noise at 2.7 V

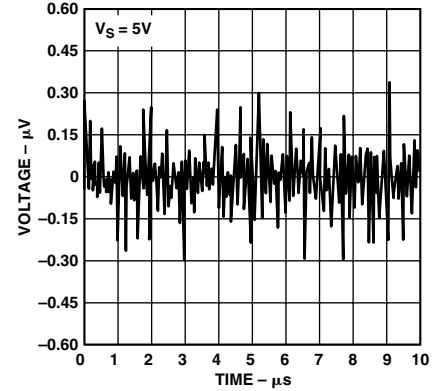

TPC 33. 0.1 Hz to 10 Hz Noise at 5 V

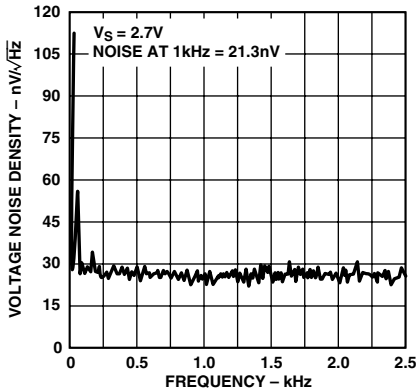

TPC 34. Voltage Noise Density at 2.7 V from 0 Hz to 2.5 kHz

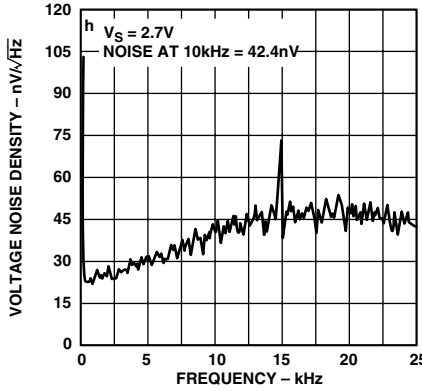

TPC 35. Voltage Noise Density at 2.7 V from 0 Hz to 25 kHz

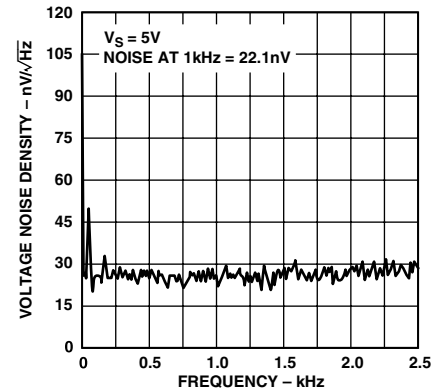

TPC 36. Voltage Noise Density at 5 V from 0 Hz to 2.5 kHz

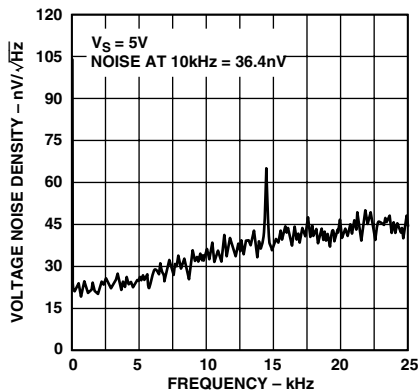

TPC 37. Voltage Noise Density at 5 V from 0 Hz to 25 kHz

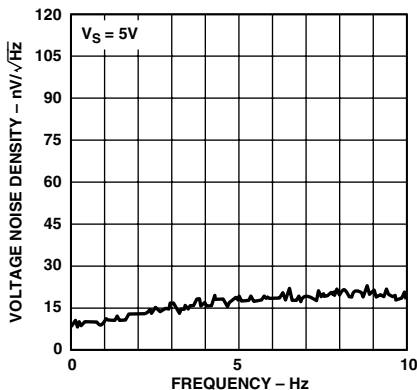

TPC 38. Voltage Noise

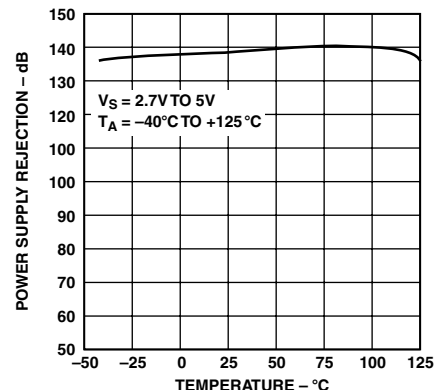

TPC 39. Power Supply Rejection vs. Temperature

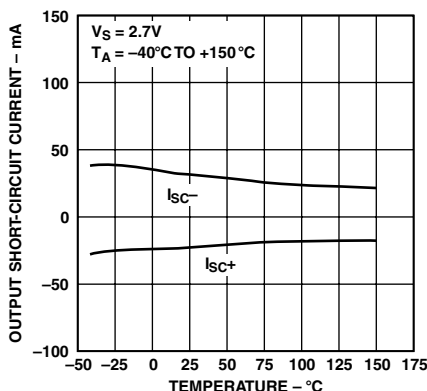

TPC 40. Output Short-Circuit Current vs. Temperature

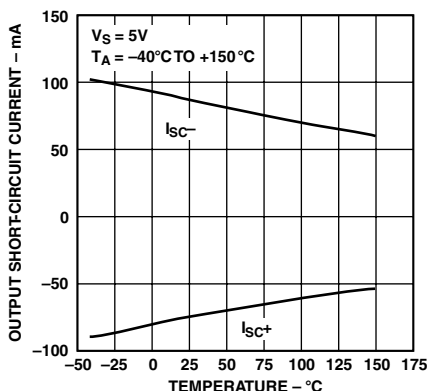

TPC 41. Output Short-Circuit Current vs. Temperature

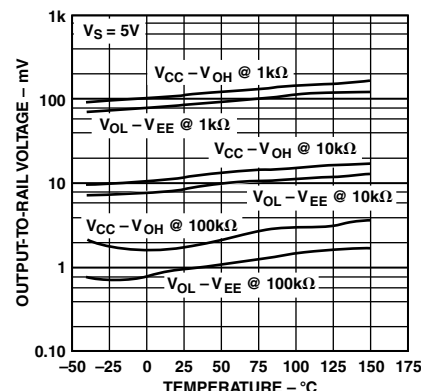

TPC 42. Output-to-Rail Voltage vs. Temperature

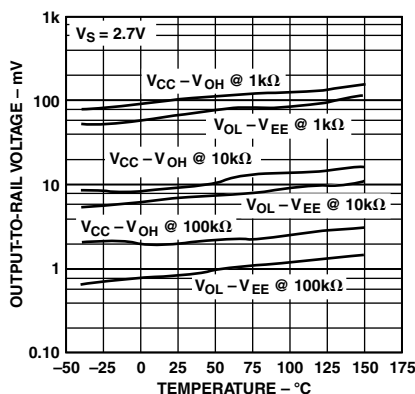

TPC 43. Output-to-Rail Voltage vs. Temperature

AD8628

FUNCTIONAL DESCRIPTION

The AD8628 is a single-supply, ultrahigh precision rail-to-rail input and output operational amplifier. The typical offset voltage of less than 1 μV allows this amplifier to be easily configured for high gains without risk of excessive output voltage errors. The extremely small temperature drift of 5 $\text{nV}/^\circ\text{C}$ ensures a minimum of offset voltage error over its entire temperature range of -40°C to $+125^\circ\text{C}$, making the AD8628 amplifier ideal for a variety of sensitive measurement applications in harsh operating environments. The AD8628 achieves a high degree of precision through a patented combination of auto-zeroing and chopping. This unique topology allows the AD8628 to maintain its low offset voltage over a wide temperature range and over its operating lifetime. AD8628 also optimizes the noise and bandwidth over previous generations of auto-zero amplifiers, offering the lowest voltage noise of any auto-zero amplifier by more than 50%.

Previous designs used either auto-zeroing or chopping to add precision to the specifications of an amplifier. Auto-zeroing results in low noise energy at the auto-zeroing frequency at the expense of higher low frequency noise due to aliasing of wideband noise into the auto-zeroed frequency band. Chopping results in lower low frequency noise at the expense of larger noise energy at the chopping frequency. AD8628 uses both auto-zeroing and chopping in a patented ping-pong arrangement to obtain lower low frequency noise together with lower energy at the chopping and auto-zeroing frequencies, maximizing the signal-to-noise ratio (SNR) for the majority of applications without the need for additional filtering. The relatively high clock frequency of 15 kHz simplifies filter requirements for a wide, useful, noise-free bandwidth.

AD8628 is one of the few auto-zero amplifiers offered in the 5-lead SOT-23 package. It greatly improves the ac parameters of the previous auto-zero amplifiers. It has low noise over a relatively wide bandwidth (0 Hz to 10 kHz) and can be used where the highest dc precision is required. In systems with signal bandwidths up to 5 kHz to 10 kHz, the AD8628 provides true 16-bit accuracy making it the best choice for very high resolution systems.

1/f Noise

1/f noise, also known as “pink noise,” is a major contributor of errors in dc-coupled measurements. This 1/f noise error term can be in the range of several μV or more, and, when amplified with the closed-loop gain of the circuit, can show up as a large output offset. For example, when an amplifier with a 5 μV p-p 1/f noise is configured for a gain of 1,000, its output will have 5 mV of error due to the 1/f noise. But AD8628 eliminates 1/f noise internally and therefore greatly reduces output errors. Here is how it works: 1/f noise appears as a slowly varying offset to AD8628 inputs. Auto-zeroing corrects any dc or low frequency offset, thus the 1/f noise component is essentially removed, leaving AD8628 free of 1/f noise.

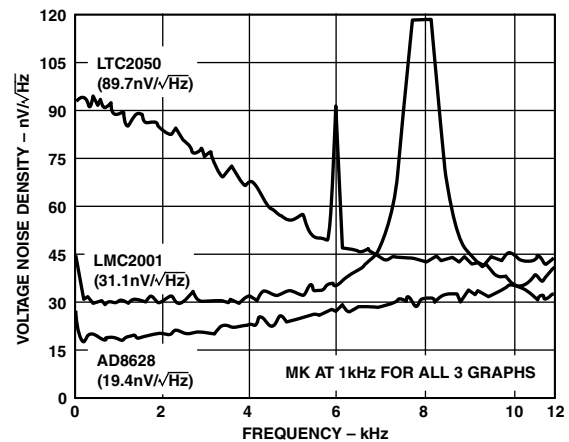

Figure 1. Noise Spectral Density of AD8628 vs. Competition

One of the biggest advantages that AD8628 brings to systems applications over competitive auto-zero amplifiers is its very low noise. The comparison shown in Figure 1 indicates an input-referred noise density of 19.4 $\text{nV}/\sqrt{\text{Hz}}$ at 1 kHz for AD8628 that is much better than the LTC2050 and LMC2001. The noise is flat from dc to 1.5 kHz, slowly increasing up to 20 kHz. The lower noise at low frequency is desirable where auto-zero amplifiers are widely used.

AD8628 Peak-to-Peak Noise vs. Competition

Because of the ping-pong action between auto-zeroing and chopping, the peak-to-peak noise of the AD8628 is much lower than its competition. Figures 2 and 3 show this comparison.

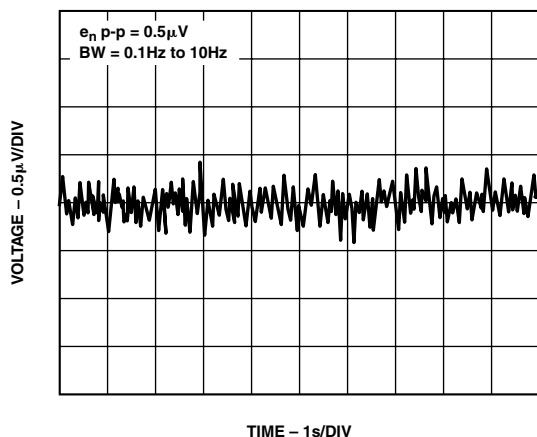

Figure 2. AD8628 Peak-to-Peak Noise

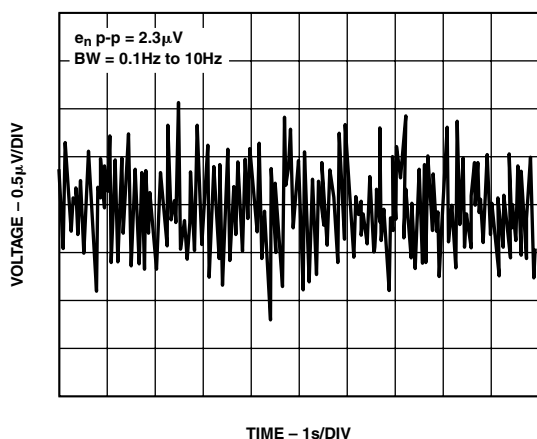

Figure 3. LTC2050 Peak-to-Peak Noise

Noise Behavior with First Order Low-Pass Filter

AD8628 was simulated as a low-pass filter and then configured as shown in Figure 4. The behavior of the AD8628 matches the simulated data. It was verified that noise is rolled off by first order filtering.

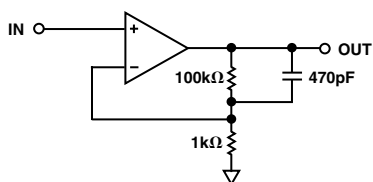

Figure 4. Test Circuit: First Order Low-Pass Filter: x101 Gain and 3 kHz Corner Frequency

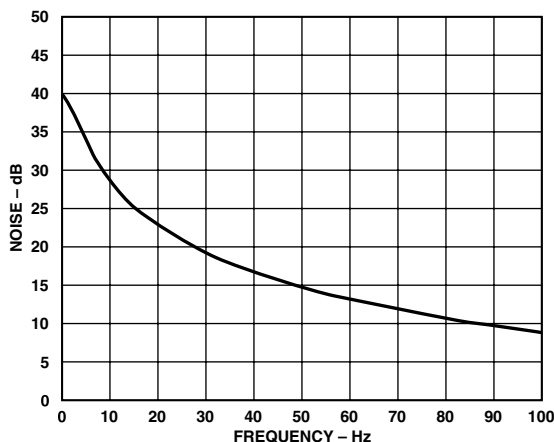

Figure 5a. Simulation Transfer Function of Test Circuit

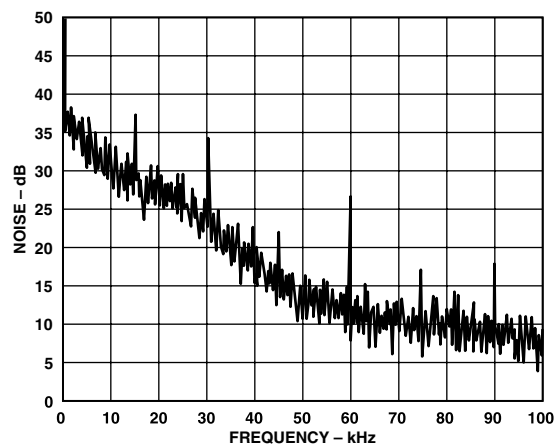

Figure 5b. Actual Transfer Function of Test Circuit

Measured noise spectrum of test circuit showing noise between 5 kHz and 45 kHz is successfully rolled off by first order filter.

Total Integrated Input-Referred Noise for First Order Filter (AD8628 vs. Competition)

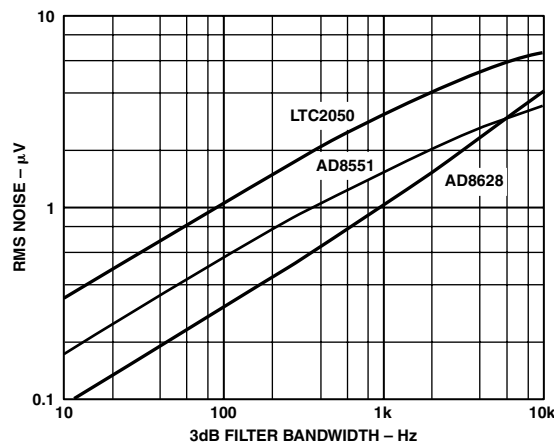

Figure 6. 3 dB Filter Bandwidth in Hz

For a first order filter, the total integrated noise from the AD8628 is lower than the LTC2050.

AD8628

Input Overvoltage Protection

Although the AD8628 is a rail-to-rail input amplifier, care should be taken to ensure that the potential difference between the inputs does not exceed the supply voltage. Under normal negative feedback operating conditions, the amplifier will correct its output to ensure the two inputs are at the same voltage. However, if either input exceeds either supply rail by more than 0.3 V, large currents will begin to flow through the ESD protection diodes in the amplifier. These diodes are connected between the inputs and each supply rail to protect the input transistors against an electrostatic discharge event and are normally reverse biased. However, if the input voltage exceeds the supply voltage, these ESD diodes will become forward biased. Without current limiting, excessive amounts of current could flow through these diodes, causing permanent damage to the device. If inputs are subject to overvoltage, appropriate series resistors should be inserted to limit the diode current to less than 5 mA maximum.

Output Phase Reversal

Output phase reversal occurs in some amplifiers when the input common-mode voltage range is exceeded. As common-mode voltage is moved outside of the common-mode range, the outputs of these amplifiers will suddenly jump in the opposite direction to the supply rail. This is the result of the differential input pair shutting down, causing a radical shifting of internal voltages that results in the erratic output behavior. The AD8628 amplifier has been carefully designed to prevent any output phase reversal, provided both inputs are maintained within the supply voltages. If one or both inputs could exceed either supply voltage, a resistor should be placed in series with the input to limit the current to less than 5 mA. This will ensure the output will not reverse its phase.

Overload Recovery Time

Many auto-zero amplifiers are plagued by long overload recovery time, often in milliseconds, due to the complicated settling behavior of the internal nulling loops after saturation of the outputs. AD8628 has been designed so that internal settling occurs within two clock cycles after output saturation happens. This results in a much shorter recovery time, less than 10 μs , when compared to other auto-zero amplifiers. The wide bandwidth of the AD8628 enhances performance when it is used to drive loads that inject transients into the outputs. This is a common situation when an amplifier is used to drive the input of switched capacitor ADCs.

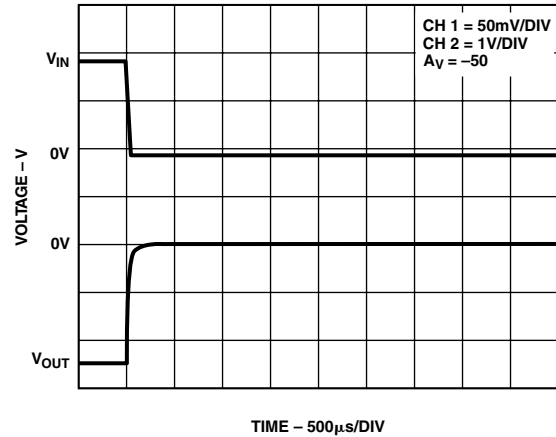

Figure 7. Positive Input Overload Recovery for AD8628

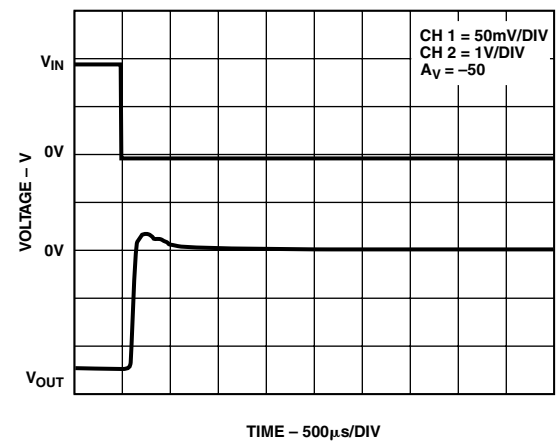

Figure 8. Positive Input Overload Recovery for LTC2050

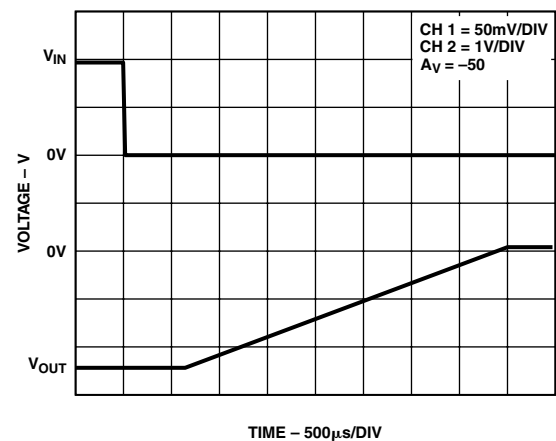

Figure 9. Positive Input Overload Recovery for LMC2001

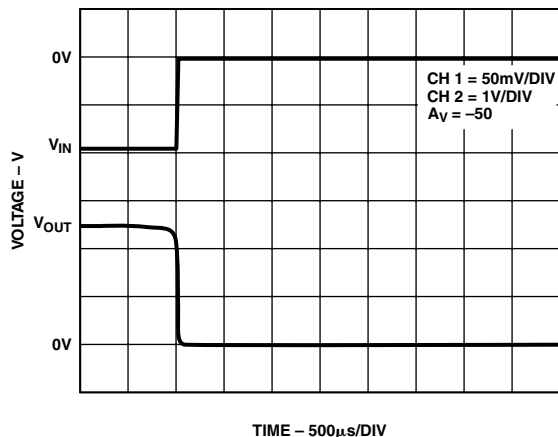

Figure 10. Negative Input Overload Recovery for AD8628

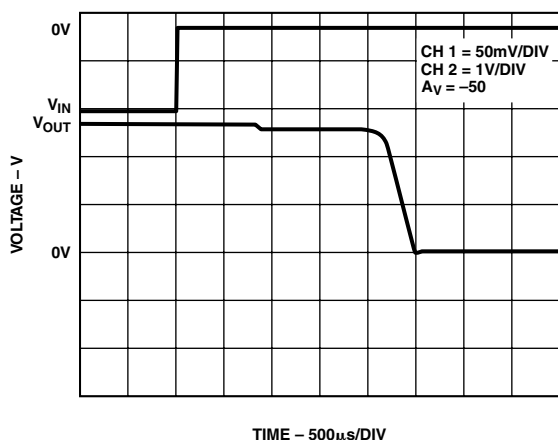

Figure 11. Negative Input Overload Recovery for LTC2050

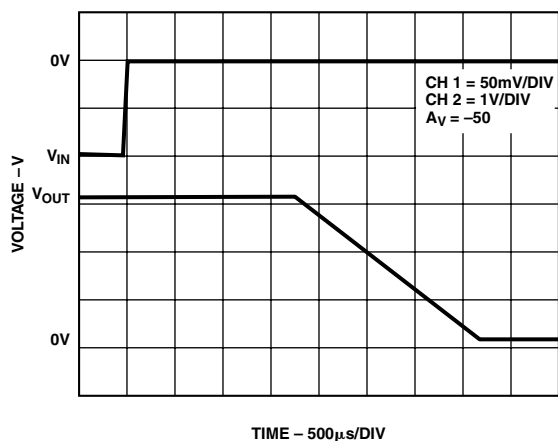

Figure 12. Negative Input Overload Recovery for LMC2001

The results shown in Figures 7-12 are summarized in Table I.

Table I. Overload Recovery Time

Product Type	Positive Overload Recovery (μs)	Negative Overload Recovery (μs)
AD8628	6	9
LTC2050	650	25,000
LMC2001	40,000	35,000

Infrared Sensors

Infrared (IR) sensors, particularly thermopiles, are increasingly being used in temperature measurement for applications as wide-ranging as automotive climate controls, human ear thermometers, home-insulation analysis, and automotive repair diagnostics. The relatively small output signal of the sensor demands high gain with very low offset voltage and drift to avoid dc errors. If interstage ac coupling is used (Figure 13), low offset and drift prevents the input amplifier's output from drifting close to saturation. The low input bias currents generate minimal errors from the sensor's output impedance. As with pressure sensors, the very low amplifier drift with time and temperature eliminates additional errors once the temperature measurement has been calibrated. The low $1/f$ noise improves SNR for dc measurements taken over periods often exceeding 1/5 second. Figure 15 shows a circuit that can amplify ac signals from 100 μV to 300 μV microvolts up to the 1 V to 3 V level, gain of 10,000 for accurate A/D conversion.

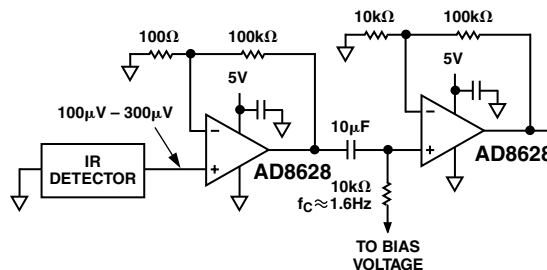

Figure 13. Preamplifier for Thermopile

AD8628

Precision Current Shunts

A precision shunt current sensor benefits from the unique attributes of auto-zero amplifiers when used in a differencing configuration (Figure 14). Shunt current sensors are used in precision current sources for feedback control systems. They are also used in a variety of other applications, including battery fuel gauging, laser diode power measurement and control, torque feedback controls in electric power steering, and precision power metering.

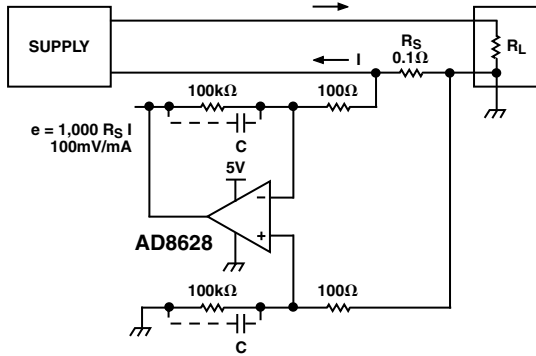

Figure 14. Low-Side Current Sensing

In such applications, it is desirable to use a shunt with very low resistance to minimize the series voltage drop; this minimizes wasted power and allows the measurement of high currents without saving power. A typical shunt might be 0.1 Ω. At measured current values of 1 A, the shunt's output signal is hundreds of millivolts, or even volts, and amplifier error sources are not critical. However, at low measured current values in the 1 mA range, the 100 μV output voltage of the shunt demands a very low offset voltage and drift to maintain absolute accuracy. Low input bias currents are also needed, so that “injected” bias current does not become a significant percentage of the measured current. High open-loop gain, CMRR, and PSRR all help to maintain the overall circuit accuracy. As long as the rate of change of the current is not too fast, an auto-zero amplifier can be used with excellent results.

Output Amplifier for High Precision DACs

AD8628 is used as an output amplifier for a 16-bit high precision DAC in unipolar configuration. In this case, the selected op amp needs to have very low offset voltage (the DAC LSB is 38 μV when operated with a 2.5 V reference) to eliminate the need for output offset trims. Input bias current (typically a few tens of pico amp) must also be very low since it generates an additional zero code error when multiplied by the DAC output impedance (approximately 6 kΩ). Rail-to-rail input and output provides full-scale output with very little error. Output impedance of the DAC is constant and code-independent, but the high input impedance of the AD8628 minimizes gain errors. The amplifier's wide bandwidth also serves well in this case. The amplifier with settling time of 1 μs adds another time constant to the system, increasing the settling time of the output. The settling time of the AD5541 is 1 μs. The combined settling time is approximately 1.4 μs, as can be derived from the equation:

$$t_s(TOTAL) = \sqrt{(t_s,DAC)^2 + (t_s,AD8628)^2}$$

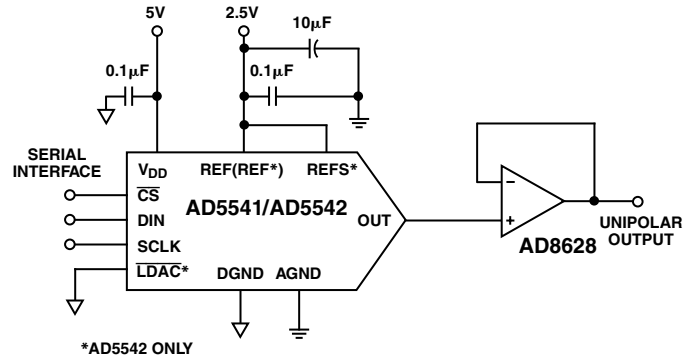
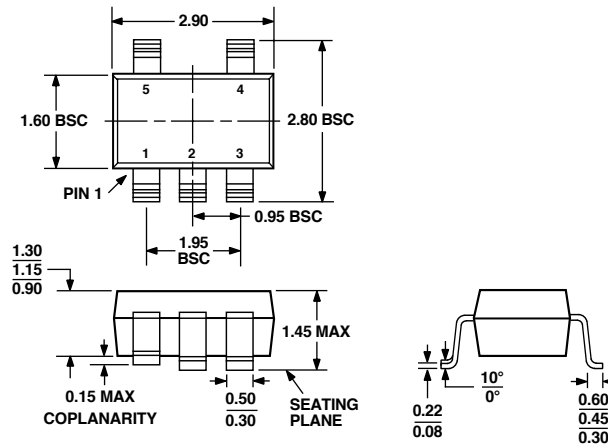

Figure 15. AD8628 Used as an Output Amplifier

OUTLINE DIMENSIONS

Dimensions shown in millimeters

5-Lead Plastic Surface-Mount Package [SOT-23]
(RT-5)



COMPLIANT TO JEDEC STANDARDS MO-178AA

Dimensions shown in millimeters and (inches)

8-Lead Standard Small Outline Package
(R-8)

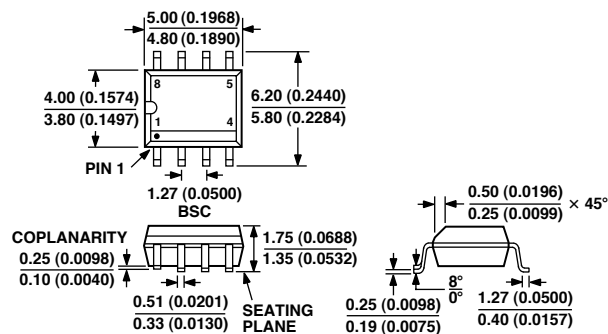

CONTROLLING DIMENSIONS ARE IN MILLIMETERS; INCH DIMENSIONS (IN PARENTHESES) ARE ROUNDED-OFF MILLIMETER EQUIVALENTS FOR REFERENCE ONLY AND ARE NOT APPROPRIATE FOR USE IN DESIGN
COMPLIANT TO JEDEC STANDARDS MS-012 AA

