

# Cree® P4 LED

## Model # LP379THR1-C0G

### Data Sheet

120-degree, 7.6 x 7.6 mm LED lamp in high-red color with water-transparent lens and stopper

#### Applications

- Advertising Signs
- Indicators
- Automotive Lighting

#### Absolute Maximum Ratings ( $T_A = 25^\circ\text{C}$ )

Items	Symbol	Absolute Maximum Rating	Unit
Forward Current <small>Note 2</small>	$I_F$	70	mA
Peak Forward Current <small>Note 1</small>	$I_{FP}$	200	mA
Reverse Voltage	$V_R$	5	V
Power Dissipation	$P_D$	220	mW
Operation Temperature	$T_{opr}$	-40 ~ +100	$^\circ\text{C}$
Storage Temperature	$T_{stg}$	-40 ~ +100	$^\circ\text{C}$
Lead Soldering Temperature	$T_{sol}$	Max. 260 $^\circ\text{C}$ for 3 sec. max. (3 mm from the base of the epoxy bulb)	

#### Notes:

1. Pulse width  $\leq 0.1$  msec, duty  $\leq 1/10$ .
2. A heat sink is recommended if the device is operated at ambient temperatures higher than 25 $^\circ\text{C}$ .

#### Typical Electrical & Optical Characteristics ( $T_A = 25^\circ\text{C}$ )

Characteristics	Symbol	Condition	Unit	Minimum	Typical	Maximum
Forward Voltage	$V_F$	$I_F = 70$ mA	V		2.6	3.2
Reverse Current	$I_R$	$V_R = 5$ V	$\mu\text{A}$			100
Dominant Wavelength	$\lambda_D$	$I_F = 70$ mA	nm	620	628	637
Luminous Flux	$\Phi_V$	$I_F = 70$ mA	mlm	3000	4000	
50% Power Angle	$2\theta_{1/2}$	$I_F = 70$ mA	deg		120	

## Standard Bins for LP379THR1-C0G (I<sub>F</sub> = 70 mA)

Lamps are sorted to luminous flux ( $\Phi_v$ ),  $V_F$  and dominant wavelength ( $\lambda_D$ ) bins shown.

Orders for LP379THR1-C0G may be filled with any or all bins contained as below.

All luminous flux ( $\Phi_v$ ),  $V_F$  and dominant wavelength ( $\lambda_D$ ) values shown and specified are at I<sub>F</sub> = 70 mA.

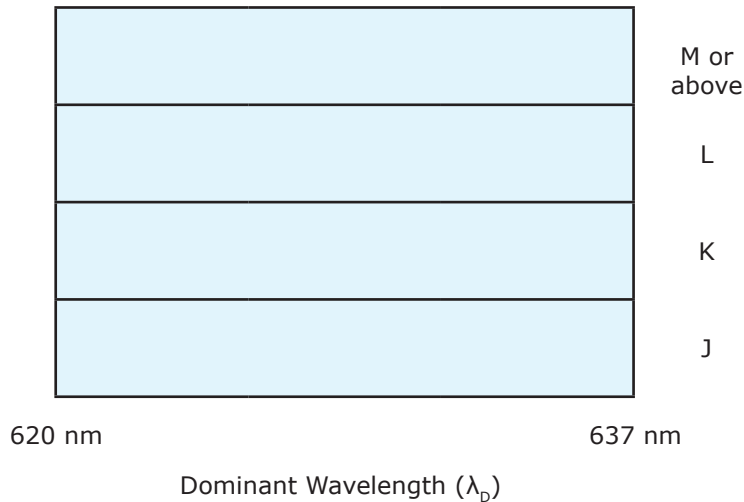

Rank	J	K	L
Luminous Flux	3000-4200 mlm	3500-4800 mlm	4000-6100 mlm

### Forward Voltage (V<sub>F</sub>)

Rank	V4	V5	V6	V7	V8
Voltage	2.2-2.4 V	2.4-2.6 V	2.6-2.8 V	2.8-3.0 V	3.0-3.2 V

### Important Notes:

- All ranks will be included per delivery; rank ratio will be based on the dice distribution.
- No tolerance of measurement of luminous flux.
- Tolerance of measurement of dominant wavelength is  $\pm 1$  nm.
- Tolerance of measurement of  $V_F$  is  $\pm 0.05$  V.
- Packaging methods are available for selection; please refer to the "Cree LED Lamp Packaging Standard" document.
- Please refer to the "Cree LED Lamp Reliability Test Standards" document for reliability test conditions.
- Please refer to the "Cree LED Lamp Soldering & Handling" document for information about how to use this LED product safely.

**Graphs**

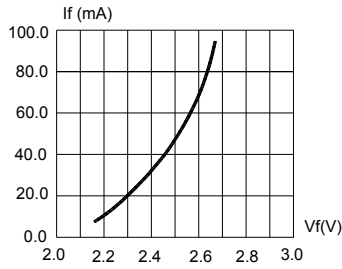

FIG.1 FORWARD CURRENT VS. FORWARD VOLTAGE.

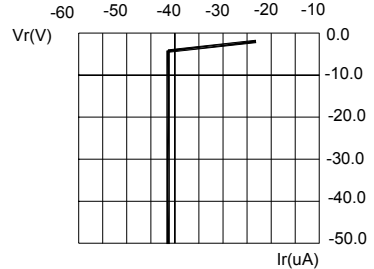

FIG.2 REVERSE CURRENT VS. REVERSE VOLTAGE.

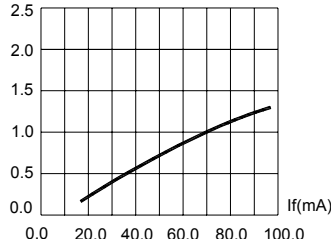

FIG.3 RELATIVE LUMINOUS FLUX VS. FORWARD CURRENT.

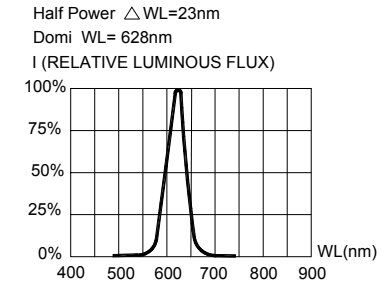

FIG.4 RELATIVE LUMINOUS FLUX VS. WAVELENGTH.

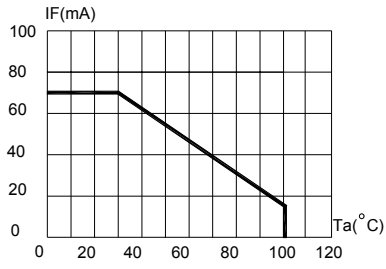

FIG.5 MAXIMUM FORWARD DC CURRENT VS AMBIENT TEMPERATURE (Tjmax=120°C)

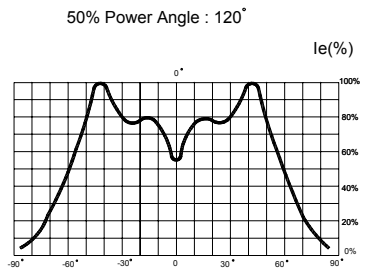

FIG.6 FAR FIELD PATTERN

## Mechanical Dimensions

All dimensions are in mm. Tolerance is  $\pm 0.25$  mm unless otherwise noted.

An epoxy meniscus may extend about 1.5 mm down the leads.

Burr around bottom of epoxy may be 0.5 mm max.

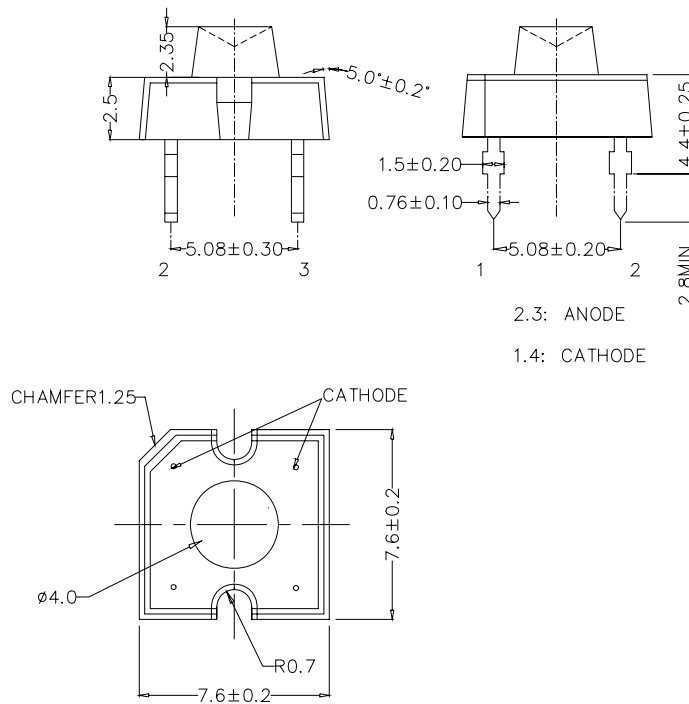

## Notes

### RoHS Compliance

The levels of environmentally sensitive, persistent biologically toxic (PBT), persistent organic pollutants (POP), or otherwise restricted materials in this product are below the maximum concentration values (also referred to as the threshold limits) permitted for such substances, or are used in an exempted application, in accordance with EU Directive 2002/95/EC on the restriction of the use of certain hazardous substances in electrical and electronic equipment (RoHS), as amended through April 21, 2006.

### Vision Advisory Claim

Users should be cautioned not to stare at the light of this LED product. The bright light can damage the eye.

## Kit Number System

Cree LED lamps are tested and sorted into performance bins. A bin is specified by ranges of color, forward voltage, and brightness. Sorted LEDs are packaged for shipping in various convenient options. Please refer to the "Cree LED Lamp Packaging Standard" document for more information about shipping and packaging options.

Cree LEDs are sold by order codes in combinations of bins called kits. Order codes are configured in the following manner:

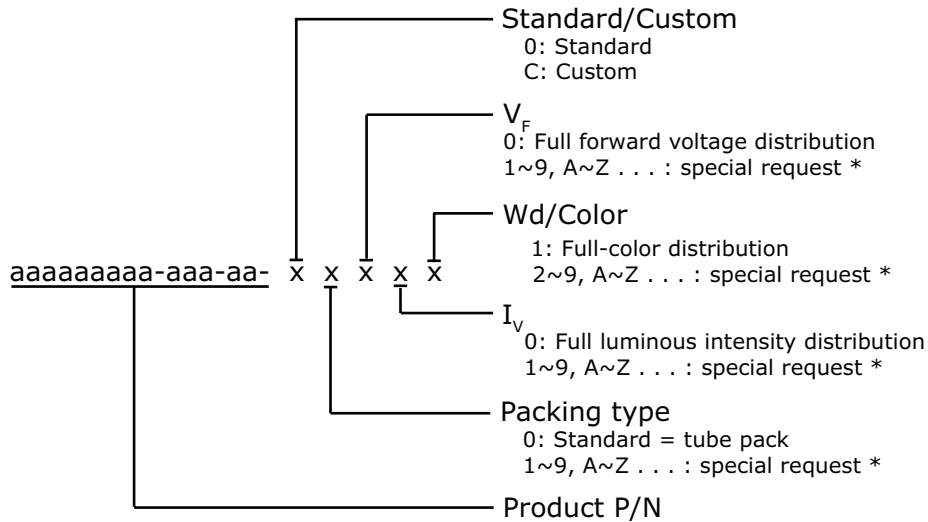

\* Contact your Cree sales representative for ordering information.

## Standard Available Kits\*

Kit Number	Description
LP379THR1-C0G-00001	P4 120 High Red 628nm, FULL RANK, Tube Pack
LP379THR1-C0G-00011	P4 120 High Red 628nm, K or above, Tube Pack

\* Please contact your Cree representative about the availability of non-standard kits.