

Typical Applications

The HMC474SC70(E) is an ideal for:

- Cellular / PCS / 3G
- WiBro / WiMAX / 4G
- Fixed Wireless & WLAN
- CATV, Cable Modem & DBS
- Microwave Radio & Test Equipment

Features

- Gain: 15 dB
- P1dB Output Power: +8 dBm
- Output IP3: +20 dBm
- Cascadable 50 Ohm I/Os
- Single Supply: +3V to +10V
- Industry Standard SC70 Package

Functional Diagram

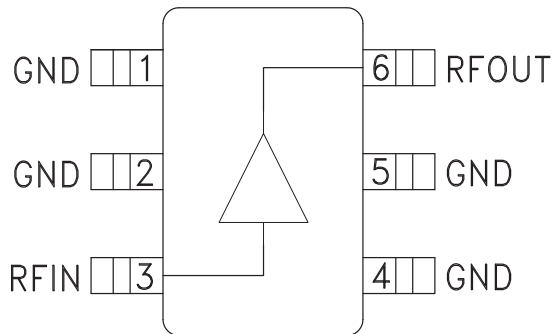

General Description

The HMC474SC70(E) is a general purpose SiGe Heterojunction Bipolar Transistor (HBT) Gain Block MMIC SMT amplifier covering DC to 6 GHz. This industry standard SC70 packaged amplifier can be used as a cascadable 50 Ohm RF/IF gain stage with up to +8 dBm output power. The HMC474SC70(E) offers 15 dB of gain with a +20 dBm output IP3 at 850 MHz while requiring only 25 mA from a single positive supply as low as +3V. The Darlington topology results in reduced sensitivity to normal process variations and excellent gain stability over temperature while requiring a minimal number of external bias components.

Electrical Specifications, $V_s = 5V$, $R_{bias} = 110 \text{ Ohm}$, $T_A = +25^\circ \text{ C}$

Parameter		Min.	Typ.	Max.	Units
Gain	DC - 2.0 GHz	12	15		dB
	2.0 - 4.0 GHz	10	13		dB
	4.0 - 6.0 GHz	7	10		dB
Gain Variation Over Temperature	DC - 6 GHz		0.01	0.015	dB/ °C
Input Return Loss	DC - 5 GHz		15		dB
	5.0 - 6.0 GHz		14		dB
Output Return Loss	DC - 5 GHz		15		dB
	5.0 - 6.0 GHz		12		dB
Reverse Isolation	DC - 6 GHz		17		dB
Output Power for 1 dB Compression (P1dB)	0.5 - 4.0 GHz	5	8		dBm
	5.0 - 6.0 GHz	3	6		dBm
Output Third Order Intercept (IP3) (Pout= 0 dBm per tone, 1 MHz spacing)	DC - 5 GHz		20		dBm
	5.0 - 6.0 GHz		18		dBm
Noise Figure	DC - 5 GHz		3		dB
	5.0 - 6.0 GHz		3.9		dB
Supply Current (Icq)			25	33	mA

Note: Data taken with broadband bias tee on device output.

Broadband Gain & Return Loss

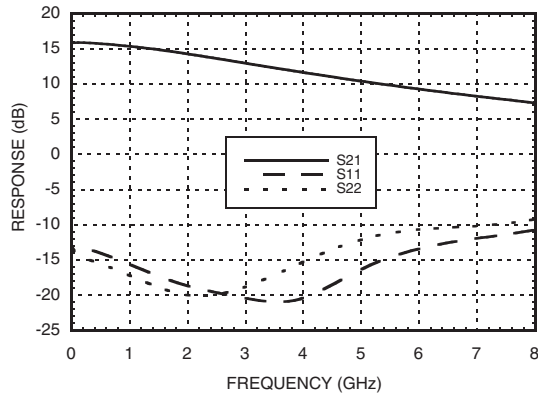

Gain vs. Temperature

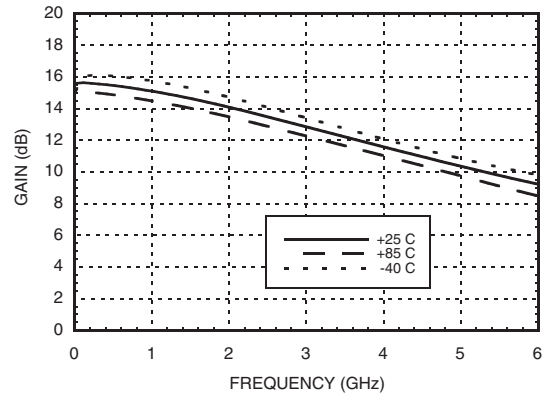

Input Return Loss vs. Temperature

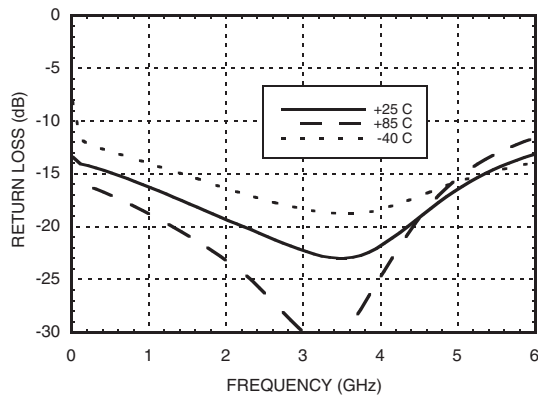

Output Return Loss vs. Temperature

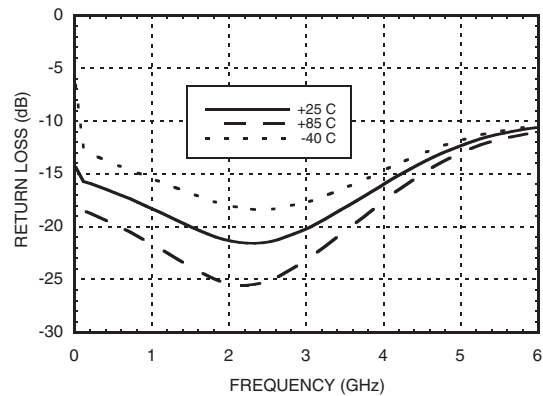

Reverse Isolation vs. Temperature

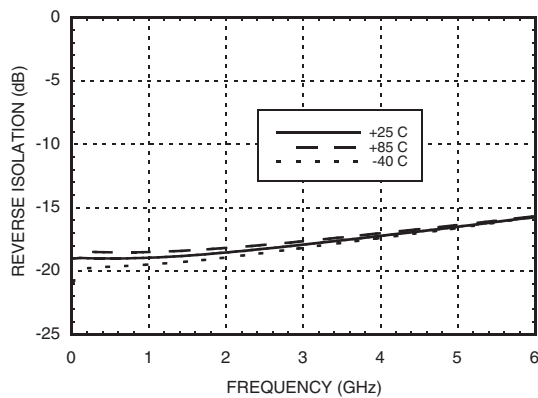

Noise Figure vs. Temperature

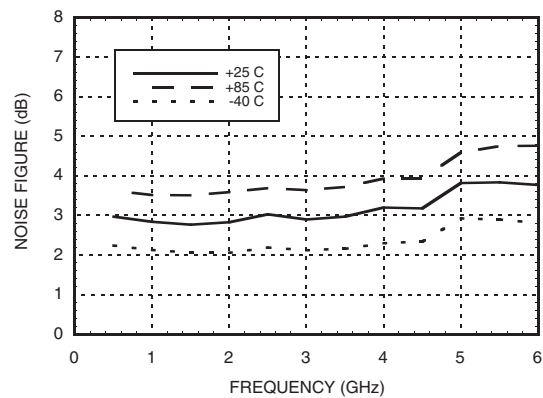



P1dB vs. Temperature

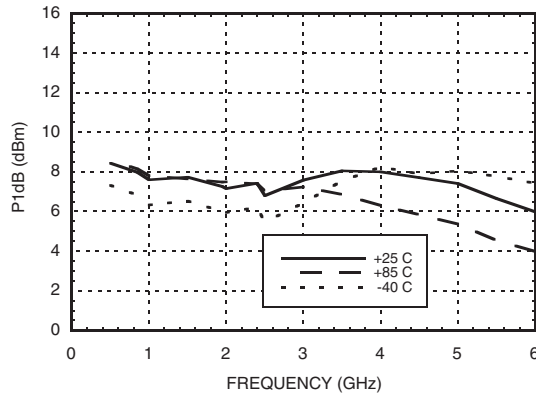

Psat vs. Temperature

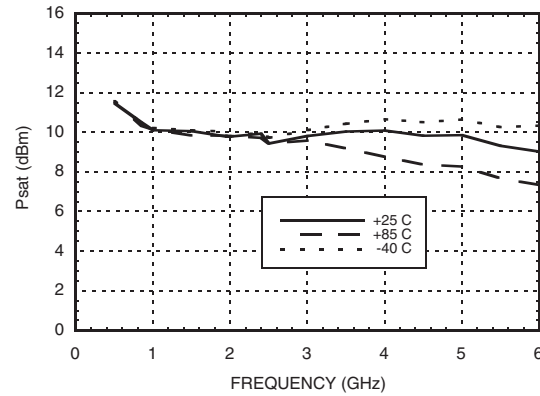

Output IP3 vs. Temperature

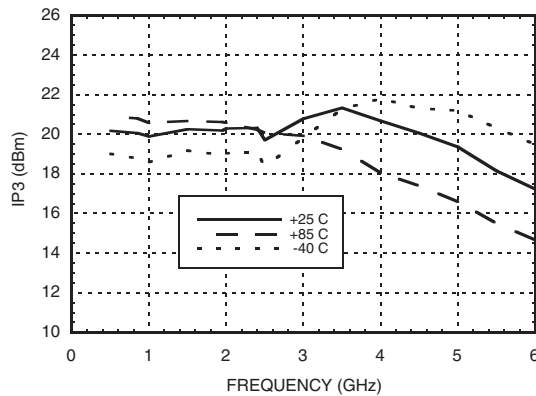

Gain, Power & OIP3 vs. Supply Voltage for Rs= 110 Ohms @ 850 MHz

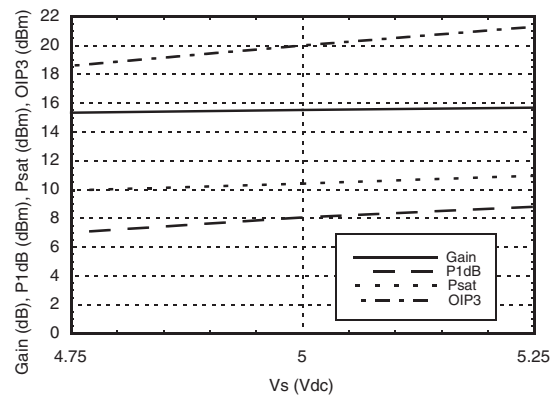

Icc vs. Vcc Over Temperature for Fixed Vs= 5V, RBIAS= 110 Ohms

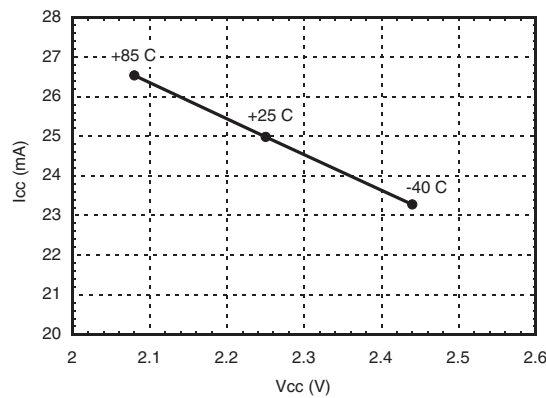

Absolute Maximum Ratings

Collector Bias Voltage (Vcc)	+6.0 Vdc
Collector Bias Current (Icc)	35 mA
RF Input Power (RFIN)(Vcc = +2.4 Vdc)	+5 dBm
Junction Temperature	150 °C
Continuous P _{diss} (T = 85 °C) (derate 4.3 mW/°C above 85 °C)	0.280 W
Thermal Resistance (junction to lead)	232 °C/W
Storage Temperature	-65 to +150 °C
Operating Temperature	-40 to +85 °C
ESD Sensitivity (HBM)	Class 1B



ELECTROSTATIC SENSITIVE DEVICE
OBSERVE HANDLING PRECAUTIONS

9

Outline Drawing

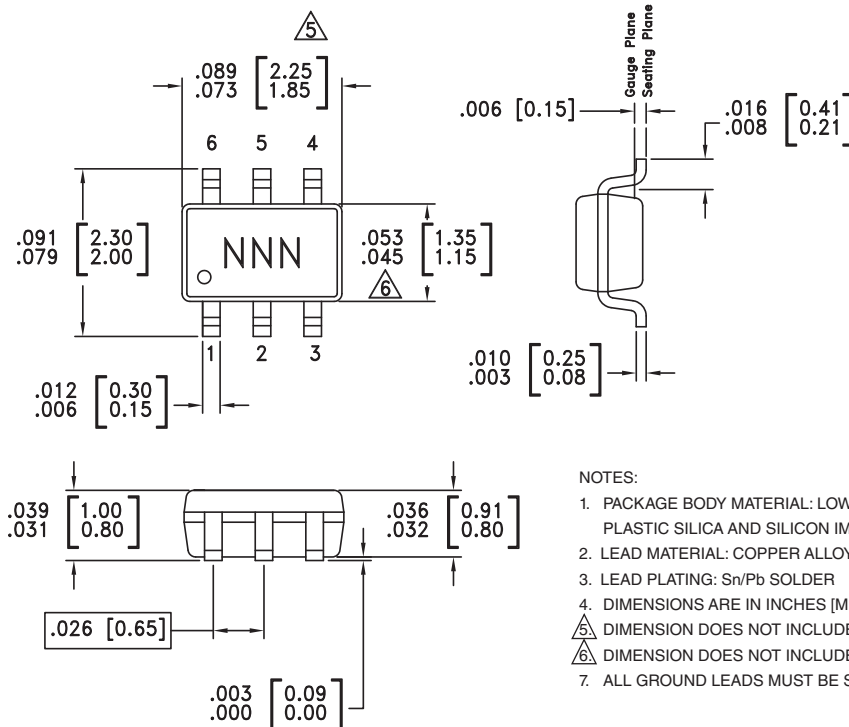

Package Information

Part Number	Package Body Material	Lead Finish	MSL Rating	Package Marking
HMC474SC70	Low Stress Injection Molded Plastic	Sn/Pb Solder	MSL1 ^[1]	474
HMC474SC70E	RoHS-compliant Low Stress Injection Molded Plastic	100% matte Sn	MSL1 ^[2]	474

[1] Max peak reflow temperature of 235 °C

[2] Max peak reflow temperature of 260 °C

Pin Descriptions

Pin Number	Function	Description	Interface Schematic
1, 2, 4, 5	GND	These pins must be connected to RF/DC ground.	
3	RFIN	This pin is DC coupled. An off chip DC blocking capacitor is required.	
6	RFOUT	RF output and DC Bias (Vcc) for the output stage.	

Application Circuit

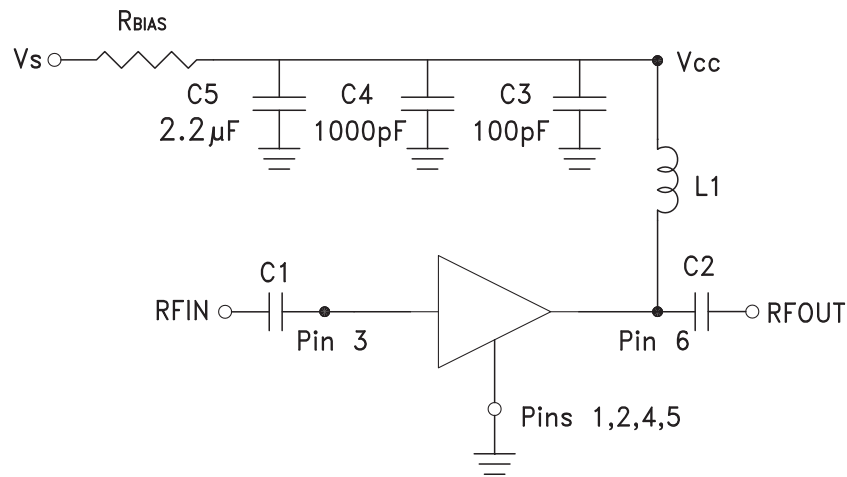

Recommended Bias Resistor Values for $I_{CC} = 25 \text{ mA}$, $R_{BIAS} = (V_s - V_{CC}) / I_{CC}$

Supply Voltage (V_s)	3V	5V	6V	8V	10V
R_{BIAS} VALUE	30 Ω	110 Ω	150 Ω	240 Ω	300 Ω
R_{BIAS} POWER RATING	1/8 W	1/8 W	1/4 W	1/2 W	1/2 W

Note:

- External blocking capacitors are required on R_{FIN} and R_{FOUT} .
- R_{BIAS} provides DC bias stability over temperature.

Recommended Component Values for Key Application Frequencies

Component	Frequency (MHz)							
	50	900	1900	2200	2400	3500	5200	5500
L1	270 nH	56 nH	18 nH	18 nH	15 nH	8.2 nH	6.8 nH	3.3 nH
C1, C2	0.01 μF	100 pF	100 pF	100 pF	100 pF	100 pF	100 pF	100 pF

Evaluation PCB

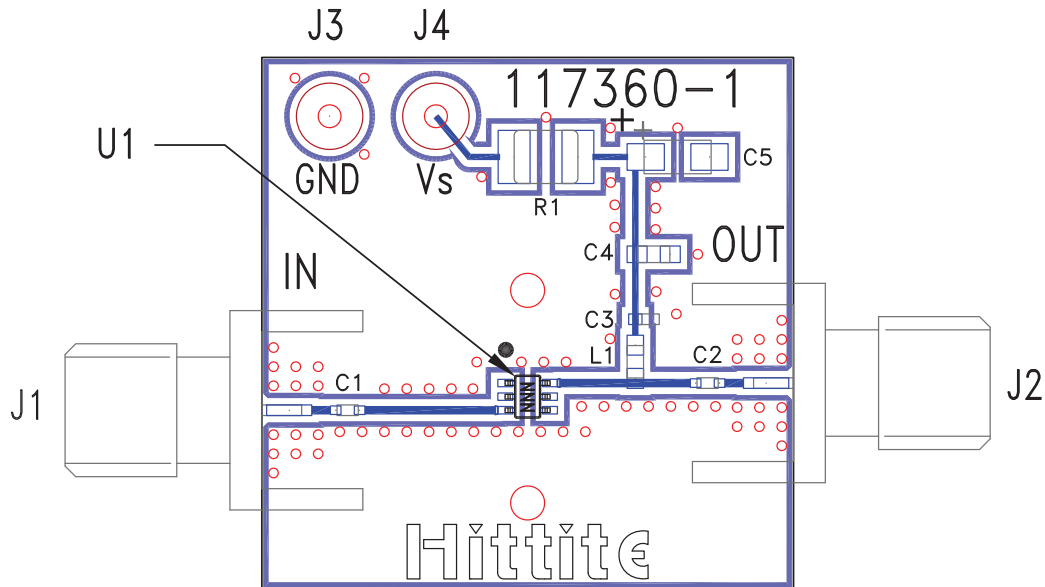

List of Materials for Evaluation PCB 117596 [1]

Item	Description
J1 - J2	PCB Mount SMA Connector
J3 - J4	DC Pin
C1 - C3	100 pF Capacitor, 0402 Pkg.
C4	1000 pF Capacitor, 0603 Pkg.
C5	2.2 μ F Capacitor, Tantalum
R1	110 Ohm Resistor, 1210 Pkg.
L1	18 nH Inductor, 0603 Pkg.
U1	HMC474SC70(E)
PCB [2]	117360 Evaluation PCB

[1] Reference this number when ordering complete evaluation PCB

[2] Circuit Board Material: Rogers 4350

The circuit board used in the final application should use RF circuit design techniques. Signal lines should have 50 ohm impedance while the package ground leads should be connected directly to the ground plane similar to that shown. A sufficient number of via holes should be used to connect the top and bottom ground planes. The evaluation board should be mounted to an appropriate heat sink. The evaluation circuit board shown is available from Hittite upon request.